

TARIFA. MARZO 2024.

HOME.

JOQUER

# SOFAS. CANAPÉS. SOFÁS.

---



CODE



DAILY



DECK MADERA



DECK TELA



GREY



JUNE BRAZO ESTRECHO



JUNE BRAZO ANCHO



MAGNUS BASE SUSPENDIDA



MAGNUS FALDÓN



PARK



PULSE 97



PULSE 117CM



SENSO BRAZO BAJO



SENSO BRAZO ALTO



SERENE 98 BRAZO ALTO  
BASE SUSPENDIDA



SERENE 98 BRAZO BAJO  
BASE SUSPENDIDA



SERENE 108 BRAZO ALTO  
BASE SUSPENDIDA



SERENE 108 BRAZO BAJO  
BASE SUSPENDIDA



SERENE 98 BRAZO ALTO  
BASE A SUELO



SERENE 98 BRAZO BAJO  
BASE A SUELO

## SOFAS. CANAPÉS. SOFÁS.

---



SERENE 108 BRAZO ALTO  
BASE A SUELO



SERENE 108 BRAZO BAJO  
BASE A SUELO



SILENCE PATAS LATERALES



SILENCE PATAS SIMPLES



SLEDD



TIME



VENICE BASE SUSPENDIDA



VENICE FALDÓN

## SOFAS BED. CANAPÉS-LIT. SOFÁS CAMA.

---



IVY



VENICE

## ARMCHAIRS. FAUTEUILS. BUTACAS.

---



BOUVIER



DECK MADERA



DECK TELA



ETHOS



GREY



HAT



MAGNUS BASE SUSPENDIDA



MAGNUS FALDÓN



MAGNUS FALDÓN



SERENE BRAZO ALTO  
BASE SUSPENDIDA



SERENE BRAZO BAJO  
BASE SUSPENDIDA



SERENE BRAZO ALTO  
BASE A SUELO



SERENE BRAZO BAJO  
BASE A SUELO



SILLA SERENE BASE SUSPENDIDA



SILLA SERENE BASE A SUELO



TIME



VENICE BASE SUSPENDIDA



VENICE FALDÓN

OTTOMANS. POUFS. OTTOMANS.

---



DEPART



DEPART SQ



SUMA BASE SUSPENDIDA



SUMA BASE A SUELO

---

TABLES. TABLES. MESAS.



AXIS



MIKA



SACHA SE



SACHA SQ



TAB CAFÉ



TAB AUXILIAR



TAB TASK



TAB WORK

---

ACCESSORIES. ACCESSOIRES. ACCESORIOS.



SERENE ESCRITORIO



MIKA BANDEJA



COJINES Y RULOS

# CODE.

# SOFA. CANAPÉ. SOFÁ.



STYLE. ESTILO.  
Essential

## FEATURES. TRAITS. CARACTERÍSTICAS.

---

Completely removable upholstery. In leather, seat and back cushions with removable covers.

Wooden frame covered with flexible cold shaped polyurethane foam and polyester fibre.

Suspension consisting of elasticated webbing in different tensions.

Seat cushions made with polyurethane foam inserts, padded with fibre and washed, sterilised down. Back cushions with polyurethane foam insert, padded with fibre and washed, sterilised down. Arm cushions with polyurethane foam insert, padded with fibre and washed, sterilised down.

Metal feet coated with polyester powder paint and manganese topcoat, with LDPE stops.

Tapiserie entièrement déhoussable. En cuir, coussins de l'assise et du dossier déhoussables.

Cadre en bois recouvert de mousse de polyuréthane souple à froid et de fibre de polyester.

Suspension au moyen de sangles élastiques entrelacées de différentes tensions.

Coussins de l'assise garnis de mousse polyuréthane, matelassés avec de la fibre et des plumes lavées et stérilisées. Coussins du dossier garnis de mousse polyuréthane, matelassés avec de la fibre et des plumes lavées et stérilisées. Coussins des accoudoirs garnis de mousse polyuréthane, matelassés avec de la fibre et des plumes lavées et stérilisées.

Pieds métalliques recouverts en peinture polyester en poudre finition manganèse avec butées en PEBD.

Tapicería totalmente desenfundable. En piel, cojines de asiento y cojines de respaldo desenfundables.

Bastidor de madera recubierto de espuma de poliuretano flexible en frío y fibra de poliéster.

Suspensión mediante cinchas elásticas entrelazadas de diferentes tensiones.

Cojines de asiento realizados con inserto de espuma de poliuretano, acolchado con fibra y pluma lavada y esterilizada. Cojines de respaldo realizados con inserto de espuma de poliuretano, acolchado con fibra y pluma lavada y esterilizada. Cojines de brazo realizados con inserto de espuma de poliuretano, acolchado con fibra y pluma lavada y esterilizada.

Patas metálicas recubiertos en pintura poliéster en polvo acabado manganeso con topes de LDPE.

CODE.

GENERAL MEASUREMENTS. MESURES GÉNÉRALES. MEDIDAS GENERALES.

---

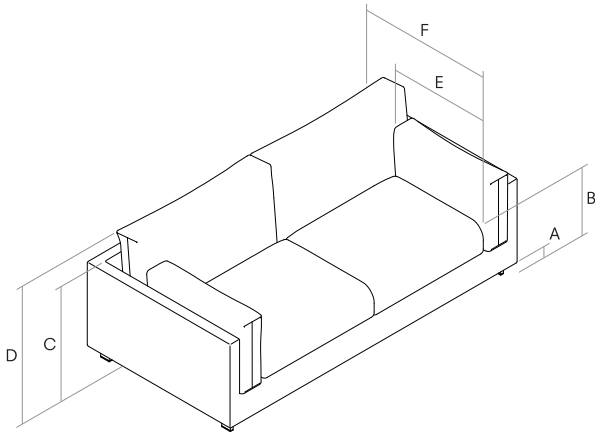

- A. Feet height. Hauteur du pied. Altura de la pata. 5 cm - 1.97"
- B. Seat height. Hauteur du siège. Altura de asiento. 44 cm - 17.32"
- C. Arm height. Hauteur du bras. Altura de brazo. 57 cm - 22.44"
- D. Backrest height. Hauteur du dossier. Altura de respaldo. 77 cm - 30.31"
- E. Seat depth. Profondeur d'assise. Profundidad de sentada. 65 cm - 25.59"
- F. Depth. Profondeur. Profundidad. 100 cm - 39.37"

FINISHES. TRAITS. ACABADOS.

---

Finishes for the metal feet. Finitions des pieds métalliques. Acabados de las patas metálicas.

---

Polyester powder paint. Peinture polyester en poudre. Pintura poliéster en polvo.

---



Manganese metal.  
Métal manganèse.  
Metal manganeso.

**CODE.**

**PRICES. PRIX. PRECIOS.**

CODE. Sofa. Canapé. Sofá.

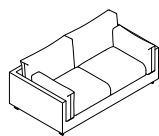

**CODS180**  
180 x 100 H77  
70.87" x 39.37" H30.31"

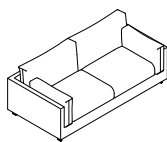

**CODS200**  
200 x 100 H77  
78.74" x 39.37" H30.31"

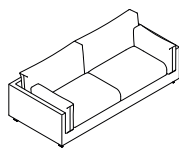

**CODS220**  
220 x 100 H77  
86.61" x 39.37" H30.31"

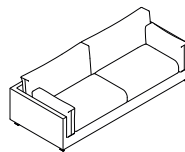

**CODS240**  
240 x 100 H77  
94.49" x 39.37" H30.31"

| MEASUREMENT. MESURE. MEDIDA.            | REF.    | M.L. | COM / COL | 1        | 2        | 3        | 4        | 5        | L1       | L2       |
|---|---------|------|-----------|----------|----------|----------|----------|----------|----------|----------|
| 180 x 100 H77   70.86" x 39.37" H30.31" | CODS180 | 11   | 1.669,42  | 1.834,71 | 1.975,21 | 2.090,91 | 2.458,68 | 3.053,72 | 3.132,23 | 3.657,02 |
| 200 x 100 H77   78.74" x 39.37" H30.31" | CODS200 | 11   | 1.772,73  | 1.913,22 | 2.070,25 | 2.210,74 | 2.500,00 | 3.123,97 | 3.235,54 | 3.752,07 |
| 220 x 100 H77   86.61" x 39.37" H30.31" | CODS220 | 11.5 | 1.880,17  | 2.020,66 | 2.169,42 | 2.309,92 | 2.615,70 | 3.256,20 | 3.334,71 | 3.876,03 |
| 240 x 100 H77   94.48" x 39.37" H30.31" | CODS240 | 12   | 2.012,40  | 2.090,91 | 2.272,73 | 2.438,02 | 2.710,74 | 3.376,03 | 3.516,53 | 4.078,51 |

CODE. Sofa with 1 arm. Canapé avec 1 accoudoir. Sofá con 1 brazo.

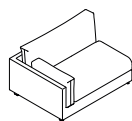

**CODSI130**  
130 x 100 H77  
51.18" x 39.37" H30.31"  
IZQ.

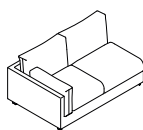

**CODSI155**  
155 x 100 H77  
61.02" x 39.37" H30.31"  
IZQ.

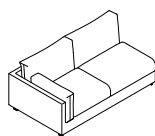

**CODSI175**  
175 x 100 H77  
68.90" x 39.37" H30.31"  
IZQ.

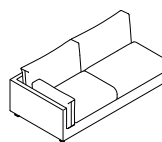

**CODSI195**  
195 x 100 H77  
76.77" x 39.37" H30.31"  
IZQ.

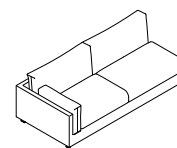

**CODSI215**  
215 x 100 H77  
84.65" x 39.37" H30.31"  
IZQ.

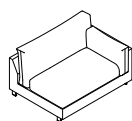

**CODSD130**  
130 x 100 H77  
51.18" x 39.37" H30.31"  
DER.

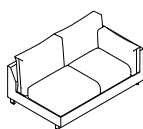

**CODSD155**  
155 x 100 H77  
61.02" x 39.37" H30.31"  
DER.

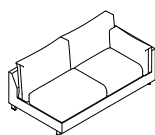

**CODSD175**  
175 x 100 H77  
68.90" x 39.37" H30.31"  
DER.

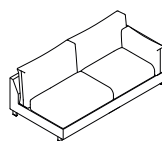

**CODSD195**  
195 x 100 H77  
76.77" x 39.37" H30.31"  
DER.

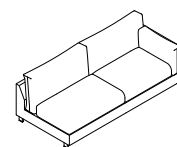

**CODSD215**  
215 x 100 H77  
84.65" x 39.37" H30.31"  
DER.

| MEASUREMENT. MESURE. MEDIDA.            | REF.                | M.L. | COM / COL | 1        | 2        | 3        | 4        | 5        | L1       | L2       |
|---|---------------------|------|-----------|----------|----------|----------|----------|----------|----------|----------|
| 130 x 100 H77   51.18" x 39.37" H30.31" | CODSI130 - CODSD130 | 6    | 1.256,20  | 1.342,98 | 1.388,43 | 1.466,94 | 1.652,89 | 2.061,98 | 2.037,19 | 2.413,22 |
| 155 x 100 H77   61.02" x 39.37" H30.31" | CODSI155 - CODSD55  | 9.5  | 1.520,66  | 1.615,70 | 1.756,20 | 1.842,98 | 2.070,25 | 2.570,25 | 2.657,02 | 3.132,23 |
| 175 x 100 H77   68.89" x 39.37" H30.31" | CODSI175 - CODSD175 | 9.5  | 1.652,89  | 1.669,42 | 1.826,45 | 1.942,15 | 2.185,95 | 2.719,01 | 2.805,79 | 3.243,80 |
| 195 x 100 H77   76.77" x 39.37" H30.31" | CODSI195 - CODSD195 | 9.5  | 1.710,74  | 1.772,73 | 1.966,94 | 2.070,25 | 2.309,92 | 2.859,50 | 2.904,96 | 3.334,71 |
| 215 x 100 H77   84.64" x 39.37" H30.31" | CODSI215 - CODSD215 | 10   | 1.818,18  | 1.904,96 | 2.020,66 | 2.090,91 | 2.413,22 | 2.975,21 | 3.008,26 | 3.446,28 |



CODE.

PRICES. PRIX. PRECIOS.

CODE. Sofa without arms. Canapé sans accoudoirs. Sofá sin brazos.

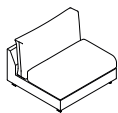

**CODS0105**

105 x 100 H77  
41.34"x 39.37" H30.31"

| MEASUREMENT. MESURE. MEDIDA.           | REF.     | M.L. | COM / COL | 1        | 2        | 3        | 4        | 5        | L1       | L2       |
|--|----------|------|-----------|----------|----------|----------|----------|----------|----------|----------|
| 105 x 100 H77   41.33"x 39.37" H30.31" | CODS0105 | 5.5  | 1.045,45  | 1.115,70 | 1.152,89 | 1.256,20 | 1.342,98 | 1.615,70 | 1.623,97 | 1.880,17 |

CODE. Corner. Angle. Rincón.

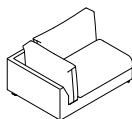

**CODRI135**

135 x 100 H77  
53.15"x 39.37" H30.31"  
IZQ.

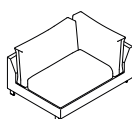

**CODRD135**

135 x 100 H77  
53.15"x 39.37" H30.31"  
DER.

| MEASUREMENT. MESURE. MEDIDA.           | REF.                | M.L. | COM / COL | 1        | 2        | 3        | 4        | 5        | L1       | L2       |
|--|---------------------|------|-----------|----------|----------|----------|----------|----------|----------|----------|
| 135 x 100 H77   53.14"x 39.37" H30.31" | CODRI135 - CODRD135 | 8    | 1.466,94  | 1.545,45 | 1.623,97 | 1.710,74 | 1.880,17 | 2.342,98 | 2.351,24 | 2.702,48 |

CODE. Chaise longue.

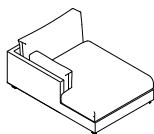

**CODCLI110**

110 x 165 H77  
43.31"x 64.96" H30.31"  
IZQ.

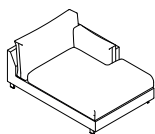

**CODCLD110**

110 x 165 H77  
43.31"x 64.96" H30.31"  
DER.

| MEASUREMENT. MESURE. MEDIDA.           | REF.                  | M.L. | COM / COL | 1        | 2        | 3        | 4        | 5        | L1       | L2       |
|--|-----------------------|------|-----------|----------|----------|----------|----------|----------|----------|----------|
| 110 x 165 H77   43.30"x 64.96" H30.31" | CODCLI110 - CODCLD110 | 8.5  | 1.545,45  | 1.623,97 | 1.669,42 | 1.871,90 | 2.090,91 | 2.607,44 | 2.685,95 | 2.921,49 |



Designer  
Mario Ruiz

STYLE. ESTILO.  
Singular

## FEATURES. TRAITS. CARACTERÍSTICAS.

---

### Fixed upholstery.

Combined wood and metal frame covered with flexible cold shaped polyurethane foam and polyester fibre.

Suspension consisting of elasticated webbing in different tensions.

Seat, back and arms in different polyurethane foam densities, with surface padding in fibre.

Metal feet coated with polyester powder paint and a manganese topcoat, with LDPE stops.

### Tapiserie fixe.

Châssis avec combinaison métal et bois recouvert de mousse de polyuréthane souple à froid et de fibre de polyester.

Suspension au moyen de sangles élastiques entrelacées de différentes tensions.

Assise, dossier et accoudoirs réalisés dans différentes densités de mousse polyuréthane, matelassés en surface avec du fibre.

Pieds métalliques recouverts en peinture polyester en poudre finition manganèse avec butées en PEBD.

### Tapizado fijo.

Bastidor combinado de metal y madera recubierto de espuma de poliuretano flexible en frío y fibra de poliéster.

Suspensión mediante cinchas elásticas entrelazadas de diferentes tensiones.

Asiento, respaldos y brazos realizados en distintas densidades de espuma de poliuretano, acolchado en la superficie con fibra.

Patas metálicas recubiertas en pintura poliéster en polvo acabado manganeso con topes de LDPE.

DAILY.

GENERAL MEASUREMENTS. MESURES GÉNÉRALES. MEDIDAS GENERALES.

---

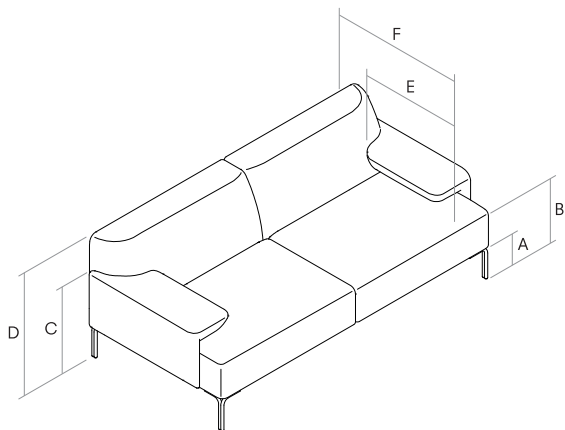

- A. Feet height. Hauteur du pied. Altura de la pata. 20 cm - 7.87"
- B. Seat height. Hauteur du siège. Altura de asiento. 44 cm - 17.32"
- C. Arm height. Hauteur du bras. Altura de brazo. 58 cm - 22.83"
- D. Backrest height. Hauteur du dossier. Altura de respaldo. 75 cm - 29.53"
- E. Seat depth. Profondeur d'assise. Profundidad de sentada. 65 cm - 25.59"
- F. Depth. Profondeur. Profundidad. 96 cm - 37.80"

FINISHES. TRAITS. ACABADOS.

---

Finishes for the metal feet. Finitions des pieds métalliques. Acabados de las patas metálicas.

---

Polyester powder paint. Peinture polyester en poudre. Pintura poliéster en polvo.

---



Manganese metal.  
Métal manganèse.  
Metal manganeso.

## DAILY.

### PRICES. PRIX. PRECIOS.

#### DAILY. Sofa. Canapé. Sofá.

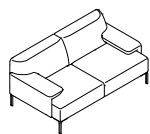

**DAIS174**  
174 x 96 H75  
68.50" x 37.80" H29.53"

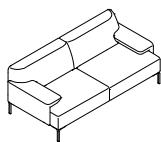

**DAIS200**  
200 x 96 H75  
78.74" x 37.80" H29.53"

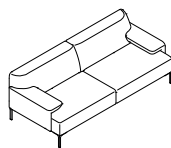

**DAIS220**  
220 x 96 H75  
86.61" x 37.80" H29.53"

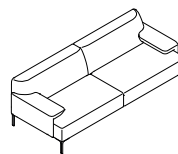

**DAIS240**  
240 x 96 H75  
94.49" x 37.80" H29.53"

| MEASUREMENT. MESURE. MEDIDA.           | REF.    | M.L. | COM / COL | 1        | 2        | 3        | 4        | 5        | L1       | L2       |
|--|---------|------|-----------|----------|----------|----------|----------|----------|----------|----------|
| 174 x 96 H75   68.50" x 37.79" H29.52" | DAIS174 | 7    | 2.252,07  | 2.338,84 | 2.413,22 | 2.520,66 | 2.714,88 | 3.078,51 | 3.165,29 | 3.504,13 |
| 200 x 96 H75   78.74" x 37.79" H29.52" | DAIS200 | 8    | 2.413,22  | 2.500,00 | 2.586,78 | 2.694,21 | 2.904,96 | 3.301,65 | 3.380,17 | 3.743,80 |
| 220 x 96 H75   86.61" x 37.79" H29.52" | DAIS220 | 9.5  | 2.586,78  | 2.657,02 | 2.760,33 | 2.867,77 | 3.078,51 | 3.475,21 | 3.561,98 | 3.938,02 |
| 240 x 96 H75   94.48" x 37.79" H29.52" | DAIS240 | 10.5 | 2.760,33  | 2.847,11 | 2.954,55 | 3.061,98 | 3.301,65 | 3.714,88 | 3.801,65 | 4.198,35 |

#### DAILY. Sofa with 1 arm. Canapé avec 1 accoudoir. Sofá con 1 brazo.

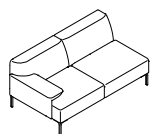

**DAISI170**  
170 x 96 H75  
66.93" x 37.80" H29.53"  
IZQ.

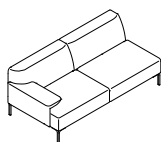

**DAISI196**  
196 x 96 H75  
77.17" x 37.80" H29.53"  
IZQ.

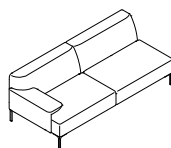

**DAISI216**  
216 x 96 H75  
85.04" x 37.80" H29.53"  
IZQ.

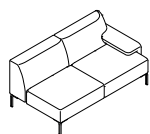

**DAISD170**  
170 x 96 H75  
66.93" x 37.80" H29.53"  
DER.

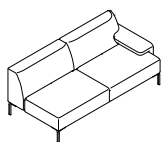

**DAISD196**  
196 x 96 H75  
77.17" x 37.80" H29.53"  
DER.

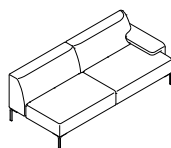

**DAISD216**  
216 x 96 H75  
85.04" x 37.80" H29.53"  
DER.

| MEASUREMENT. MESURE. MEDIDA.           | REF.                | M.L. | COM / COL | 1        | 2        | 3        | 4        | 5        | L1       | L2       |
|--|---------------------|------|-----------|----------|----------|----------|----------|----------|----------|----------|
| 170 x 96 H75   66.92" x 37.79" H29.52" | DAISI170 - DAISD170 | 7    | 2.223,14  | 2.297,52 | 2.396,69 | 2.462,81 | 2.628,10 | 2.975,21 | 3.033,06 | 3.338,84 |
| 196 x 96 H75   77.16" x 37.79" H29.52" | DAISI196 - DAISD196 | 7.5  | 2.326,45  | 2.396,69 | 2.471,07 | 2.578,51 | 2.743,80 | 3.078,51 | 3.165,29 | 3.466,94 |
| 216 x 96 H75   85.03" x 37.79" H29.52" | DAISI216 - DAISD216 | 8    | 2.413,22  | 2.491,74 | 2.586,78 | 2.673,55 | 2.859,50 | 3.235,54 | 3.301,65 | 3.640,50 |

DAILY.

PRICES. PRIX. PRECIOS.

DAILY. Corner. Angle. Rincón.

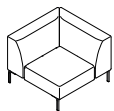

**DAIR96**

96 x 96 H75  
37.80" x 37.80" H30.31"

| MEASUREMENT. MESURE. MEDIDA.          | REF.   | M.L. | COM / COL | 1        | 2        | 3        | 4        | 5        | L1       | L2       |
|---------------------------------------|--------|------|-----------|----------|----------|----------|----------|----------|----------|----------|
| 96 x 96 H75   37.79" x 37.79" H29.52" | DAIR96 | 6    | 1.760,33  | 1.760,33 | 1.805,79 | 1.863,64 | 2.000,00 | 2.252,07 | 2.289,26 | 2.500,00 |

DAILY. Chaise longue.

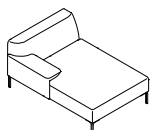

**DAICLI110**

110 x 160 H75  
43.31" x 62.99" H29.53"  
IZQ.

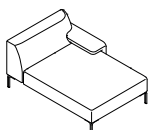

**DAICLD110**

110 x 160 H75  
43.31" x 62.99" H29.53"  
DER.

| MEASUREMENT. MESURE. MEDIDA.            | REF.                  | M.L. | COM / COL | 1        | 2        | 3        | 4        | 5        | L1       | L2       |
|---|-----------------------|------|-----------|----------|----------|----------|----------|----------|----------|----------|
| 110 x 160 H75   43.30" x 62.99" H29.52" | DAICLI110 - DAICLD110 | 6    | 1.892,56  | 1.950,41 | 2.020,66 | 2.086,78 | 2.210,74 | 2.500,00 | 2.549,59 | 2.789,26 |



Designer  
Mario Ruiz

STYLE. ESTILO.  
Singular

VERSION. VERSIÓN.  
External wooden structure. Structure extérieur en bois. Estructura exterior de madera.

## FEATURES. TRAITS. CARACTERÍSTICAS.

Removable upholstery in seat base, seat, back and auxiliary cushions. In leather, seat, back and auxiliary cushions with completely removable covers.

Wooden frame covered with flexible cold shaped polyurethane foam and polyester fibre.

Suspension consisting of elasticated webbing in different tensions.

External structure in MDF, ultralight American walnut veneer, or dark-dyed oak. Upholstered interior.

Seat cushions in different polyurethane foam densities, with surface padding in fibre. Back cushions stuffed with polyester fibre and washed, sterilised down. Auxiliary cushions stuffed with polyester fibre and washed, sterilised down.

Metal bases coated in polyester powder paint with a manganese topcoat and LDPE stops.

The materials finishes are shown in photographic table charts. When ordering, specify the product code together with the code of the chosen finish.

Tapiserie déhoussable sur la base de l'assise, coussins de l'assise, du dossier et coussins auxiliaires. En cuir, coussins de l'assise, du dossier et auxiliaires déhoussables.

Cadre en bois recouvert de mousse de polyuréthane souple à froid et de fibre de polyester.

Suspension au moyen de sangles élastiques entrelacées de différentes tensions.

Structure extérieure en DM ultraléger noyer plaqué américain ou chêne teinté de couleur foncée. Intérieur tapissé.

Coussins de l'assise réalisés dans différentes densités de mousse polyuréthane, matelassés en surface avec du fibre. Coussins du dossier garnis de fibre de polyester et plumes lavées et stérilisées. Coussins auxiliaires garnis de fibre de polyester et plumes lavées et stérilisées.

Bases métalliques en peinture polyester en poudre finition manganèse avec butées en PEBD.

Les finitions des matériaux sont représentées avec des tableaux photographiques. Lors de toute commande, il sera nécessaire d'indiquer le code du produit, associé au code de la finition choisie.

Tapicería desenfundable en base de asiento, cojines de asiento, cojines de respaldo y cojines auxiliares. En piel, cojines de asiento, cojines de respaldo y cojines auxiliares desenfundables.

Bastidor de madera recubierto de espuma de poliuretano flexible en frío y fibra de poliéster.

Suspensión mediante cinchas elásticas entrelazadas de diferentes tensiones.

Estructura exterior en DM ultraligero chapado en nogal americano o roble tintado oscuro. Interior tapizado.

Cojines de asiento realizados en distintas densidades de espuma de poliuretano, acolchado en la superficie con fibra. Cojines de respaldo rellenos de fibra de poliéster y pluma lavada y esterilizada. Cojines auxiliares rellenos de fibra de poliéster y pluma lavada y esterilizada.

Patatas metálicas en pintura poliéster en polvo acabado manganeso con topes de LDPE.

Los acabados de los materiales se representan a través de tablas fotográficas. Al realizar el pedido será necesario indicar el código de producto combinado con el código del acabado elegido.

## DECK.

### GENERAL MEASUREMENTS. MESURES GÉNÉRALES. MEDIDAS GENERALES.

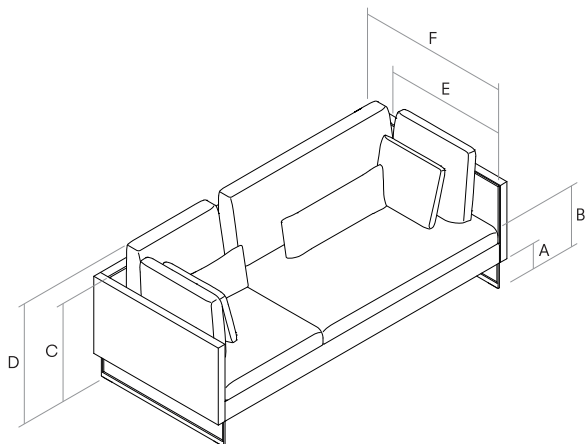

- A. Base height. Hauteur de la base. Altura de la pata. 17 cm - 6.69"
- B. Seat height. Hauteur du siège. Altura de asiento. 44 cm - 17.32"
- C. Arm height. Hauteur du bras. Altura de brazo. 69 cm - 27.17"
- D. Backrest height. Hauteur du dossier. Altura de respaldo. 89 cm - 35.04"
- E. Seat depth. Profondeur d'assise. Profundidad de sentada. 72 cm - 28.35"
- F. Depth. Profondeur. Profundidad. 95 cm - 37.40"

### FINISHES. TRAITS. ACABADOS.

Finishes for the metal feet. Finitions des pieds métalliques. Acabados de las patas metálicas.

Polyester powder paint. Peinture polyester en poudre. Pintura poliéster en polvo.



Manganese metal.  
Métal manganèse.  
Metal manganeso.

Finishes for the external wooden structure. Finitions de la structure extérieure en bois. Acabados de las estructura exterior de madera.

Wood finishes. Finitions bois. Acabado de la madera.



**RN**  
Natural oak.  
Chêne naturel.  
Roble natural.



**NA**  
Natural american walnut.  
Noyer américain.  
Nogal americano.



**RT**  
Dark stained oak.  
Chêne teint foncée.  
Roble teñido oscuro.



**RL**  
Oak painted in black with open-pore finish.  
Chêne laqué noir à pores ouverts.  
Roble lacado negro por abierto.

How to complete the reference. Comment remplir la référence. Cómo completar la referencia.

Example. Exemple. Ejemplo.

1. Select the product. Sélectionner le produit.  
Seleccionar el producto.

2. Select the finish. Sélectionner le finition.  
Seleccionar el acabado.

3. Reference completed. Référence remplie.  
Referencia completada.

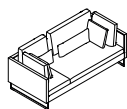

**DECS200**  
200 x 95 H89  
78.74" x 37.40" H35.04"



**RN**  
Natural oak.  
Chêne naturel.  
Roble natural.

**DECS200RN**  
DECK sofa, 200cm, natural oak finish.  
Canapé DECK, 200 cm, finition chêne naturel.  
Sofá DECK, 200 cm, acabado roble natural.

## DECK.

### PRICES. PRIX. PRECIOS.

#### DECK. Sofa. Canapé. Sofá.

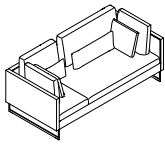

**DECS200**

200 x 95 H89  
78.74" x 37.40" H35.04"

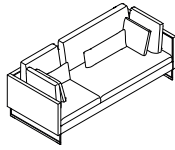

**DECS220**

220 x 95 H89  
86.61" x 37.40" H35.04"

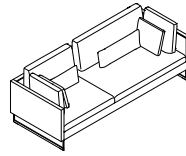

**DECS240**

240 x 95 H89  
94.49" x 37.40" H35.04"

| MEASUREMENT. MESURE. MEDIDA.           | REF.    | M.L. | COM / COL | 1        | 2        | 3        | 4        | 5        | L1       | L2       |
|--|---------|------|-----------|----------|----------|----------|----------|----------|----------|----------|
| 200 x 95 H89   78.74" x 37.40" H35.03" | DECS200 | 9    | 3.351,24  | 3.512,40 | 3.611,57 | 3.727,27 | 3.983,47 | 4.582,64 | 4.628,10 | 5.045,45 |
| 220 x 95 H89   86.61" x 37.40" H35.03" | DECS220 | 9.5  | 3.520,66  | 3.706,61 | 3.805,79 | 3.942,15 | 4.227,27 | 4.859,50 | 4.983,47 | 5.421,49 |
| 240 x 95 H89   94.48" x 37.40" H35.03" | DECS240 | 10.5 | 3.752,07  | 3.942,15 | 4.037,19 | 4.198,35 | 4.528,93 | 5.198,35 | 5.359,50 | 5.834,71 |

#### DECK. Sofa with 1 arm. Canapé avec 1 accoudoir. Sofá con 1 brazo.

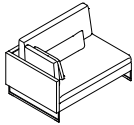

**DECSI140**

140 x 95 H89  
55.12" x 37.40" H35.04"  
IZQ.

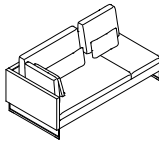

**DECSI195**

195 x 95 H89  
76.77" x 37.40" H35.04"  
IZQ.

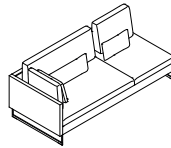

**DECSI215**

215 x 95 H89  
84.65" x 37.40" H35.04"  
IZQ.

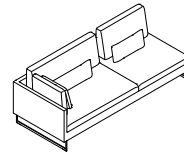

**DECSI235**

235 x 95 H89  
92.52" x 37.40" H35.04"  
IZQ.

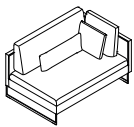

**DECS140**

140 x 95 H89  
55.12" x 37.40" H35.04"  
DER.

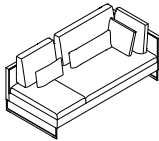

**DECS195**

195 x 95 H89  
76.77" x 37.40" H35.04"  
DER.

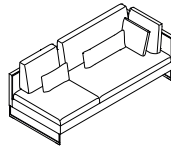

**DECS215**

215 x 95 H89  
84.65" x 37.40" H35.04"  
DER.

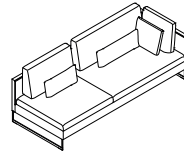

**DECS235**

235 x 95 H89  
92.52" x 37.40" H35.04"  
DER.

| MEASUREMENT. MESURE. MEDIDA.           | REF.               | M.L. | COM / COL | 1        | 2        | 3        | 4        | 5        | L1       | L2       |
|--|--------------------|------|-----------|----------|----------|----------|----------|----------|----------|----------|
| 140 x 95 H89   55.11" x 37.40" H35.03" | DECSI140 - DECS140 | 6.5  | 2.590,91  | 2.719,01 | 2.764,46 | 2.851,24 | 3.066,12 | 3.520,66 | 3.574,38 | 3.859,50 |
| 195 x 95 H89   76.77" x 37.40" H35.03" | DECSI195 - DECS195 | 8    | 3.173,55  | 3.272,73 | 3.351,24 | 3.458,68 | 3.590,91 | 4.144,63 | 4.342,98 | 4.673,55 |
| 215 x 95 H89   84.64" x 37.40" H35.03" | DECSI215 - DECS215 | 9    | 3.227,27  | 3.380,17 | 3.483,47 | 3.590,91 | 3.880,17 | 4.458,68 | 4.574,38 | 4.983,47 |
| 235 x 95 H89   92.51" x 37.40" H35.03" | DECSI235 - DECS235 | 10   | 3.483,47  | 3.673,55 | 3.780,99 | 3.913,22 | 4.227,27 | 4.859,50 | 4.983,47 | 5.421,49 |



**DECK.**

PRICES. PRIX. PRECIOS.

DECK. Corner. Angle. Rincón.

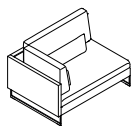

**DECRI135**

135 x 95 H89  
53.15" x 37.40" H35.04"  
IZQ.

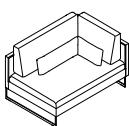

**DECRD135**

135 x 95 H89  
53.15" x 37.40" H35.04"  
DER.

| MEASUREMENT. MESURE. MEDIDA.           | REF.                | M.L. | COM / COL | 1        | 2        | 3        | 4        | 5        | L1       | L2       |
|--|---------------------|------|-----------|----------|----------|----------|----------|----------|----------|----------|
| 135 x 95 H89   53.14" x 37.40" H35.03" | DECRI135 - DECRD135 | 6.5  | 2.380,17  | 2.504,13 | 2.549,59 | 2.657,02 | 2.851,24 | 3.198,35 | 3.227,27 | 3.636,36 |

DECK. Chaise longue.

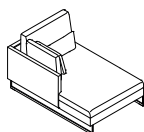

**DECCLI100**

100 x 155 H89  
39.37" x 61.02" H35.04"  
IZQ.

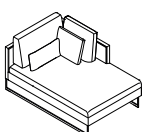

**DECCLD100**

100 x 155 H89  
39.37" x 61.02" H35.04"  
DER.

| MEASUREMENT. MESURE. MEDIDA.            | REF.                  | M.L. | COM / COL | 1        | 2        | 3        | 4        | 5        | L1       | L2       |
|---|-----------------------|------|-----------|----------|----------|----------|----------|----------|----------|----------|
| 100 x 155 H89   39.37" x 61.02" H35.03" | DECCLI100 - DECCLD100 | 7    | 2.495,87  | 2.611,57 | 2.657,02 | 2.764,46 | 2.958,68 | 3.396,69 | 3.466,94 | 3.752,07 |



Designer  
Mario Ruiz

STYLE. ESTILO.  
Singular

VERSION. VERSIÓN.  
Upholstered external structure. Structure extérieur tapissée. Estructura exterior tapizada.

## FEATURES. TRAITS. CARACTERÍSTICAS.

Complete removable upholstery.  
In leather, seat, back and auxiliary  
cushions with removable covers.

Wooden frame covered with flexible  
cold shaped polyurethane foam and  
polyester fibre.

Suspension consisting of elasticated  
webbing in different tensions.

Seat cushions in different  
polyurethane foam densities, with  
surface padding in fibre. Back  
cushions stuffed with polyester fibre  
and washed, sterilised down. Auxiliary  
cushions stuffed with polyester fibre  
and washed, sterilised down.

Metal bases coated with polyester  
powder paint with a manganese  
topcoat and LDPE stops.

Tapiserie entièrement déhoussable.  
En cuir, coussins de l'assise, du  
dossier et auxiliaires déhoussables.

Cadre en bois recouvert de mousse  
de polyuréthane souple à froid et de  
fibre de polyester.

Suspension au moyen de sangles  
élastiques entrelacées de différentes  
tensions.

Coussins de l'assise réalisés dans  
différentes densités de mousse  
polyuréthane, matelassés en surface  
avec du fibre. Coussins du dossier  
garnis de fibre de polyester et de  
plumes lavées et stérilisées. Coussins  
auxiliaires garnis de fibre de polyester  
et de plumes lavées et stérilisées.

Bases métalliques recouverts en  
peinture polyester en poudre finition  
manganèse avec butées en PEBD.

Tapicería totalmente desenfundable.  
En piel, cojines de asiento, cojines  
de respaldo y cojines auxiliares  
desenfundables.

Bastidor de madera recubierto de  
espuma de poliuretano flexible en frío  
y fibra de poliéster.

Suspensión mediante cinchas  
elásticas entrelazadas de diferentes  
tensiones.

Cojines de asiento realizados en  
distintas densidades de espuma  
de poliuretano, acolchado en la  
superficie con fibra. Cojines de  
respaldo rellenos de fibra de poliéster  
y pluma lavada y esterilizada.  
Cojines auxiliares rellenos de fibra  
de poliéster y pluma lavada y  
esterilizada.

Patas metálicas recubiertas en  
pintura poliéster en polvo acabado  
manganeso con topes de LDPE.

## DECK.

### GENERAL MEASUREMENTS. MESURES GÉNÉRALES. MEDIDAS GENERALES.

---

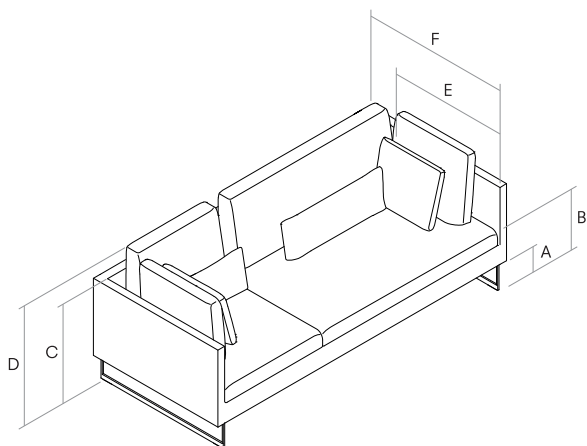

- A. Base height. Hauteur de la base. Altura de la pata. 17 cm - 6.69"
- B. Seat height. Hauteur du siège. Altura de asiento. 44 cm - 17.32"
- C. Arm height. Hauteur du bras. Altura de brazo. 69 cm - 27.17"
- D. Backrest height. Hauteur du dossier. Altura de respaldo. 89 cm - 35.04"
- E. Seat depth. Profondeur d'assise. Profundidad de sentada. 72 cm - 28.35"
- F. Depth. Profondeur. Profundidad. 95 cm - 37.40"

### FINISHES. TRAITS. ACABADOS.

---

Finishes for the metal feet. Finitions des pieds métalliques. Acabados de las patas metálicas.

---

Polyester powder paint. Peinture polyester en poudre. Pintura poliéster en polvo.

---



Manganese metal.  
Métal manganèse.  
Metal manganeso.

DECK.

PRICES. PRIX. PRECIOS.

DECK. Sofa. Canapé. Sofá.

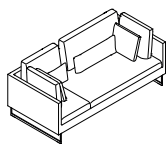

**DECS200TA**

200 x 95 H89  
78.74" x 37.40" H35.04"

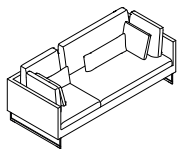

**DECS220TA**

220 x 95 H89  
86.61" x 37.40" H35.04"

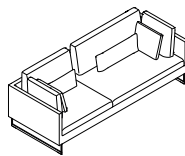

**DECS240TA**

240 x 95 H89  
94.49" x 37.40" H35.04"

| MEASUREMENT. MESURE. MEDIDA.           | REF.      | M.L. | COM / COL | 1        | 2        | 3        | 4        | 5        | L1       | L2       |
|--|-----------|------|-----------|----------|----------|----------|----------|----------|----------|----------|
| 200 x 95 H89   78.74" x 37.40" H35.03" | DECS200TA | 10   | 2.450,41  | 2.590,91 | 2.743,80 | 2.904,96 | 3.227,27 | 3.859,50 | 3.983,47 | 4.557,85 |
| 220 x 95 H89   86.61" x 37.40" H35.03" | DECS220TA | 10.5 | 2.611,57  | 2.743,80 | 2.904,96 | 3.074,38 | 3.396,69 | 4.082,64 | 4.219,01 | 4.834,71 |
| 240 x 95 H89   94.48" x 37.40" H35.03" | DECS240TA | 12   | 2.764,46  | 2.933,88 | 3.119,83 | 3.305,79 | 3.673,55 | 4.404,96 | 4.549,59 | 5.206,61 |

DECK. Sofa with 1 arm. Canapé avec 1 accoudoir. Sofá con 1 brazo.

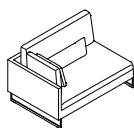

**DECSI140TA**

140 x 95 H89  
55.12" x 37.40" H35.04"  
IZQ.

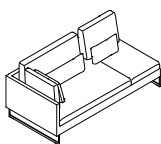

**DECSI195TA**

195 x 95 H89  
76.77" x 37.40" H35.04"  
IZQ.

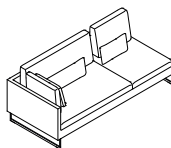

**DECSI215TA**

215 x 95 H89  
84.65" x 37.40" H35.04"  
IZQ.

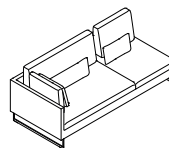

**DECSI235TA**

235 x 95 H89  
92.52" x 37.40" H35.04"  
IZQ.

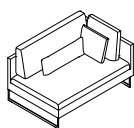

**DECS140TA**

140 x 95 H89  
55.12" x 37.40" H35.04"  
DER.

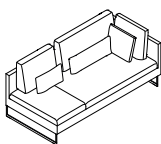

**DECS195TA**

195 x 95 H89  
76.77" x 37.40" H35.04"  
DER.

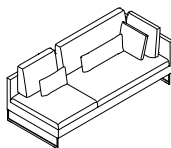

**DECS215TA**

215 x 95 H89  
84.65" x 37.40" H35.04"  
DER.

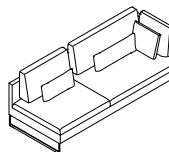

**DECS235TA**

235 x 95 H89  
92.52" x 37.40" H35.04"  
DER.

| MEASUREMENT. MESURE. MEDIDA.           | REF.                   | M.L. | COM / COL | 1        | 2        | 3        | 4        | 5        | L1       | L2       |
|--|------------------------|------|-----------|----------|----------|----------|----------|----------|----------|----------|
| 140 x 95 H89   55.11" x 37.40" H35.03" | DECSI140TA - DECS140TA | 7    | 1.743,80  | 1.805,79 | 1.913,22 | 2.020,66 | 2.227,27 | 2.628,10 | 2.710,74 | 3.066,12 |
| 195 x 95 H89   76.77" x 37.40" H35.03" | DECSI195TA - DECS195TA | 8.5  | 2.227,27  | 2.342,98 | 2.504,13 | 2.628,10 | 2.933,88 | 3.442,15 | 3.549,59 | 4.037,19 |
| 215 x 95 H89   84.64" x 37.40" H35.03" | DECSI215TA - DECS215TA | 9.5  | 2.380,17  | 2.504,13 | 2.628,10 | 2.764,46 | 3.082,64 | 3.636,36 | 3.752,07 | 4.243,80 |
| 235 x 95 H89   92.51" x 37.40" H35.03" | DECSI235TA - DECS235TA | 10   | 2.549,59  | 2.657,02 | 2.851,24 | 2.966,94 | 3.305,79 | 3.867,77 | 3.995,87 | 4.557,85 |

**DECK.**

**PRICES. PRIX. PRECIOS.**

**DECK. Corner. Angle. Rincón.**

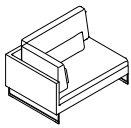

**DECRI135TA**

135 x 95 H89  
53.15" x 37.40" H35.04"  
IZQ.

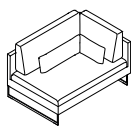

**DECRD135TA**

135 x 95 H89  
53.15" x 37.40" H35.04"  
DER.

| MEASUREMENT. MESURE. MEDIDA.           | REF.                    | M.L. | COM / COL | 1        | 2        | 3        | 4        | 5        | L1       | L2       |
|--|-------------------------|------|-----------|----------|----------|----------|----------|----------|----------|----------|
| 135 x 95 H89   53.14" x 37.40" H35.03" | DECRI135TA - DECRD135TA | 6.5  | 1.896,69  | 2.020,66 | 2.128,10 | 2.227,27 | 2.504,13 | 3.020,66 | 3.119,83 | 3.590,91 |

**DECK. Chaise longue.**

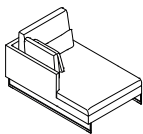

**DECCLI100TA**

100 x 155 H89  
39.37" x 61.02" H35.04"  
IZQ.

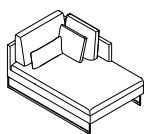

**DECCLD100TA**

100 x 155 H89  
39.37" x 61.02" H35.04"  
DER.

| MEASUREMENT. MESURE. MEDIDA.            | REF.                      | M.L. | COM / COL | 1        | 2        | 3        | 4        | 5        | L1       | L2       |
|---|---------------------------|------|-----------|----------|----------|----------|----------|----------|----------|----------|
| 100 x 155 H89   39.37" x 61.02" H35.03" | DECCLI100TA - DECCLD100TA | 7.5  | 2.111,57  | 2.181,82 | 2.318,18 | 2.421,49 | 2.557,85 | 3.157,02 | 3.252,07 | 3.706,61 |

**DECK. Ottomans. Poufs. Ottomans.**

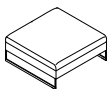

**DECP95TA**

95 x 95 H44  
37.40" x 37.40" H17.32"

| MEASUREMENT. MESURE. MEDIDA.          | REF.     | M.L. | COM / COL | 1      | 2        | 3        | 4        | 5        | L1       | L2       |
|---------------------------------------|----------|------|-----------|--------|----------|----------|----------|----------|----------|----------|
| 95 x 95 H44   37.40" x 37.40" H17.32" | DECP95TA | 3    | 958,68    | 987,60 | 1.041,32 | 1.057,85 | 1.157,02 | 1.334,71 | 1.371,90 | 1.520,66 |

# GREY.

# SOFA. CANAPÉ. SOFÁ.



Designer  
Mario Ruiz

STYLE. ESTILO.  
Singular

## FEATURES. TRAITS. CARACTERÍSTICAS.

---

### Fixed upholstery.

Combined wood and metal frame covered with flexible cold shaped polyurethane foam and polyester fibre.

Seat, back and arms in different polyurethane foam densities, with surface padding in fibre.

Metal feet coated with polyester powder paint and a manganese topcoat, with LDPE stops.

### Tapiserie fixe.

Châssis avec combinaison métal et bois recouvert de mousse de polyuréthane souple à froid et de fibre de polyester.

Assise, dossier et accoudoirs réalisés dans différentes densités de mousse polyuréthane, matelassés en surface avec du fibre.

Pieds métalliques recouverts en peinture polyester en poudre finition manganèse avec butées en PEBD.

### Tapizado fijo.

Bastidor combinado de metal y madera recubierto de espuma de poliuretano flexible en frío y fibra de poliéster.

Asiento, respaldo y brazos realizados en distintas densidades de espuma de poliuretano, acolchado en la superficie con fibra.

Patas metálicas recubiertas en pintura poliéster en polvo acabado manganeso con topes de LDPE.

GREY.

GENERAL MEASUREMENTS. MESURES GÉNÉRALES. MEDIDAS GENERALES.

---

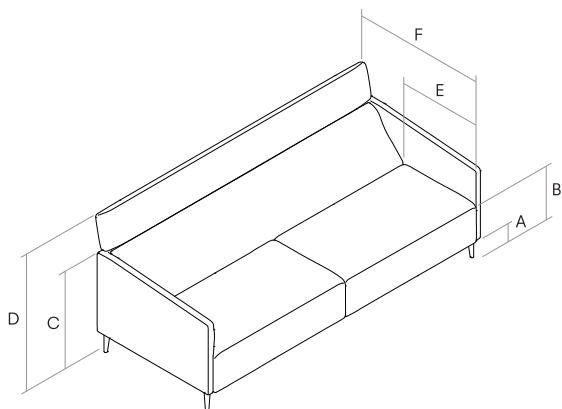

- A. Feet height. Hauteur du pied. Altura de la pata. 13 cm - 5.12"
- B. Seat height. Hauteur du siège. Altura de asiento. 41 cm - 16.14"
- C. Arm height. Hauteur du bras. Altura de brazo. 60 cm - 23.62"
- D. Backrest height. Hauteur du dossier. Altura de respaldo. 90 cm - 22.83"
- E. Seat depth. Profondeur d'assise. Profundidad de sentada. 58 cm - 28.35"
- F. Depth. Profondeur. Profundidad. 87 cm - 34.25"

FINISHES. TRAITS. ACABADOS.

---

Finishes for the metal feet. Finitions des pieds métalliques. Acabados de las patas metálicas.

---

Polyester powder paint. Peinture polyester en poudre. Pintura poliéster en polvo.

---



Manganese metal.  
Métal manganèse.  
Metal manganeso.

GREY.

PRICES. PRIX. PRECIOS.

GREY. Sofa. Canapé. Sofá.

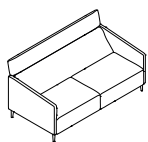

**GRES170**

170 x 87 H90  
66.93" x 34.25" H35.43"

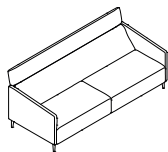

**GRES190**

190 x 87 H90  
74.80" x 34.25" H35.43"

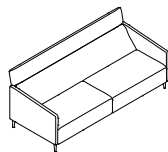

**GRES210**

210 x 87 H90  
82.68" x 34.25" H35.43"

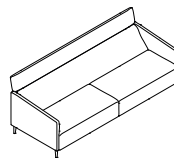

**GRES230**

230 x 87 H90  
90.55" x 34.25" H35.43"

| MEASUREMENT. MESURE. MEDIDA.           | REF.    | M.L. | COM / COL | 1        | 2        | 3        | 4        | 5        | L1       | L2       |
|--|---------|------|-----------|----------|----------|----------|----------|----------|----------|----------|
| 170 x 87 H90   66.92" x 34.25" H35.43" | GRES170 | 8.5  | 1.528,93  | 1.615,70 | 1.710,74 | 1.818,18 | 2.020,66 | 2.438,02 | 2.528,93 | 2.904,96 |
| 190 x 87 H90   74.80" x 34.25" H35.43" | GRES190 | 8.5  | 1.632,23  | 1.723,14 | 1.834,71 | 1.929,75 | 2.140,50 | 2.570,25 | 2.657,02 | 3.053,72 |
| 210 x 87 H90   82.67" x 34.25" H35.43" | GRES210 | 8.5  | 1.723,14  | 1.801,65 | 1.913,22 | 2.037,19 | 2.247,93 | 2.727,27 | 2.818,18 | 3.210,74 |
| 230 x 87 H90   90.55" x 34.25" H35.43" | GRES230 | 9    | 1.834,71  | 1.929,75 | 2.037,19 | 2.140,50 | 2.388,43 | 2.851,24 | 2.929,75 | 3.351,24 |





# JUNE.

# SOFA. CANAPÉ. SOFÁ.



STYLE. ESTILO.  
Essential

VERSION. VERSIÓN.  
Narrow arm version. Version à bras étroit. Version de brazo estrecho. (6 cm - 2.36 in)

## FEATURES. TRAITS. CARACTERÍSTICAS.

---

Completely removable upholstery.  
In leather, seat, back and auxiliary  
cushions with removable covers.

Wooden frame covered with flexible  
cold shaped polyurethane foam and  
polyester fibre.

Suspension consisting of elasticated  
webbing in different tensions.

Seat cushions made with  
polyurethane foam inserts,  
padded with fibre and washed,  
sterilised down. Back cushions with  
polyurethane foam insert, padded  
with fibre and washed, sterilised  
down. Auxiliary cushions with  
polyurethane foam insert, padded  
with fibre and washed, sterilised  
down.

Metal feet coated with polyester  
powder paint and a manganese  
topcoat, with LDPE stops.

Tapiserie entièrement déhoussable.  
En cuir, coussins de l'assise, du  
dossier et auxiliaires déhoussables.

Cadre en bois recouvert de mousse  
de polyuréthane souple à froid et de  
fibre de polyester.

Suspension au moyen de sangles  
élastiques entrelacées de différentes  
tensions.

Coussins de l'assise garnis de  
mousse polyuréthane, matelassés  
avec de la fibre et des plumes lavées  
et stérilisées. Coussins du dossier  
garnis de fibre de polyester et  
plumes lavées et stérilisées. Coussins  
auxiliaires garnis de fibre de polyester  
et plumes lavées et stérilisées.

Pieds métalliques recouverts en  
peinture polyester en poudre finition  
manganèse avec butées en PEBD.

Tapicería totalmente desenfundable.  
En piel, cojines de asiento, cojines  
de respaldo y cojines auxiliares  
desenfundables.

Bastidor de madera recubierto de  
espuma de poliuretano flexible en frío  
y fibra de poliéster.

Suspensión mediante cinchas  
elásticas entrelazadas de diferentes  
tensiones.

Cojines de asiento realizados con  
inserto de espuma de poliuretano,  
acolchado con fibra y pluma lavada  
y esterilizada. Cojines de respaldo  
reellenos de fibra de poliéster  
y pluma lavada y esterilizada.  
Cojines auxiliares reellenos de fibra  
de poliéster y pluma lavada y  
esterilizada.

Patas metálicas recubiertas en  
pintura poliéster en polvo acabado  
manganeso con topes de LDPE.

## JUNE.

### GENERAL MEASUREMENTS. MESURES GÉNÉRALES. MEDIDAS GENERALES.

---

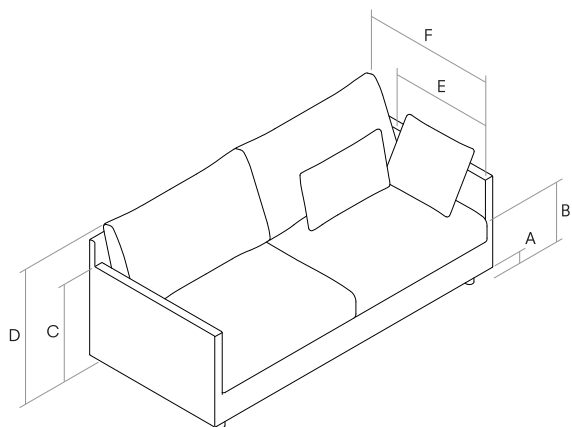

- A. Feet height. Hauteur du pied. Altura de la pata. 10 cm - 3.94"
- B. Seat height. Hauteur du siège. Altura de asiento. 45 cm - 17.72"
- C. Arm height. Hauteur du bras. Altura de brazo. 61 cm - 24.02"
- D. Backrest height. Hauteur du dossier. Altura de respaldo. 87 cm - 34.25"
- E. Seat depth. Profondeur d'assise. Profundidad de sentada. 60 cm - 23.62"
- F. Depth. Profondeur. Profundidad. 95 cm - 37.40"

### FINISHES. TRAITS. ACABADOS.

---

Finishes for the metal feet. Finitions des pieds métalliques. Acabados de las patas metálicas.

---

Polyester powder paint. Peinture polyester en poudre. Pintura poliéster en polvo.

---



Manganese metal.  
Métal manganèse.  
Metal manganeso.

## JUNE.

### PRICES. PRIX. PRECIOS.

#### JUNE. Sofa. Canapé. Sofá.

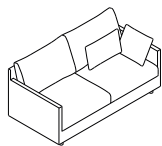

**JUNS190BE**

190 x 95 H87  
74.80" x 37.40" H34.25"

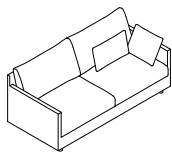

**JUNS210BE**

210 x 95 H87  
82.68" x 37.40" H34.25"

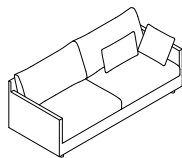

**JUNS230BE**

230 x 95 H87  
90.55" x 37.40" H34.25"

| MEASUREMENT. MESURE. MEDIDA.           | REF.      | M.L. | COM / COL | 1        | 2        | 3        | 4        | 5        | L1       | L2       |
|--|-----------|------|-----------|----------|----------|----------|----------|----------|----------|----------|
| 190 x 95 H87   74.80" x 37.40" H34.25" | JUNS190BE | 9    | 1.772,73  | 1.880,17 | 2.012,40 | 2.148,76 | 2.429,75 | 2.966,94 | 3.078,51 | 3.545,45 |
| 210 x 95 H87   82.67" x 37.40" H34.25" | JUNS210BE | 9.5  | 1.942,15  | 2.053,72 | 2.090,91 | 2.334,71 | 2.607,44 | 3.177,69 | 3.289,26 | 3.789,26 |
| 230 x 95 H87   90.55" x 37.40" H34.25" | JUNS230BE | 10.5 | 2.090,91  | 2.185,95 | 2.359,50 | 2.500,00 | 2.818,18 | 3.421,49 | 3.533,06 | 4.078,51 |

#### JUNE. Sofa with 1 arm. Canapé avec 1 accoudoir. Sofá con 1 brazo.

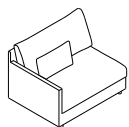

**JUNS1125BE**

125 x 95 H87  
49.21" x 37.40" H34.25"  
IZQ.

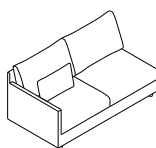

**JUNS1185BE**

185 x 95 H87  
72.83" x 37.40" H34.25"  
IZQ.

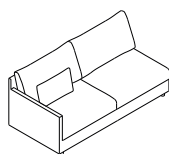

**JUNS1205BE**

205 x 95 H87  
80.71" x 37.40" H34.25"  
IZQ.

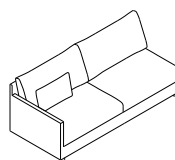

**JUNS1225BE**

225 x 95 H87  
88.58" x 37.40" H34.25"  
IZQ.

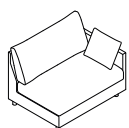

**JUNSD125BE**

125 x 95 H87  
49.21" x 37.40" H34.25"  
DER.

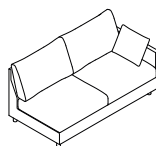

**JUNSD185BE**

185 x 95 H87  
72.83" x 37.40" H34.25"  
DER.

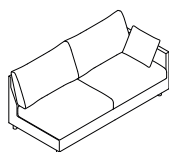

**JUNSD205BE**

205 x 95 H87  
80.71" x 37.40" H34.25"  
DER.

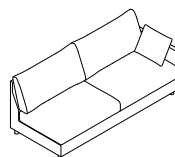

**JUNSD225BE**

225 x 95 H87  
88.58" x 37.40" H34.25"  
DER.

| MEASUREMENT. MESURE. MEDIDA.           | REF.                    | M.L. | COM / COL | 1        | 2        | 3        | 4        | 5        | L1       | L2       |
|--|-------------------------|------|-----------|----------|----------|----------|----------|----------|----------|----------|
| 125 x 95 H87   49.21" x 37.40" H34.25" | JUNS1125BE - JUNSD125BE | 6    | 1.309,92  | 1.363,64 | 1.466,94 | 1.545,45 | 1.710,74 | 2.053,72 | 2.115,70 | 2.404,96 |
| 185 x 95 H87   72.83" x 37.40" H34.25" | JUNS1185BE - JUNSD185BE | 8    | 1.623,97  | 1.739,67 | 1.859,50 | 1.983,47 | 2.219,01 | 2.702,48 | 2.797,52 | 3.243,80 |
| 205 x 95 H87   80.70" x 37.40" H34.25" | JUNS1205BE - JUNSD205BE | 8.5  | 1.772,73  | 1.880,17 | 2.012,40 | 2.148,76 | 2.404,96 | 2.921,49 | 3.024,79 | 3.500,00 |
| 225 x 95 H87   88.58" x 37.40" H34.25" | JUNS1225BE - JUNSD225BE | 9.5  | 1.942,15  | 2.028,93 | 2.177,69 | 2.297,52 | 2.578,51 | 3.132,23 | 3.256,20 | 3.752,07 |

## JUNE.

### PRICES. PRIX. PRECIOS.

#### JUNE. Corner. Angle. Rincón.

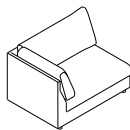

#### JUNRI135

135 x 95 H87  
53.15" x 37.40" H34.25"  
IZQ.

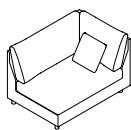

#### JUNRD135

185 x 95 H87  
53.15" x 37.40" H34.25"  
DER.

| MEASUREMENT. MESURE. MEDIDA.           | REF.                | M.L. | COM / COL | 1        | 2        | 3        | 4        | 5        | L1       | L2       |
|--|---------------------|------|-----------|----------|----------|----------|----------|----------|----------|----------|
| 135 x 95 H87   53.14" x 37.40" H34.25" | JUNRI135 - JUNRD135 | 7    | 1.520,66  | 1.599,17 | 1.710,74 | 1.801,65 | 2.028,93 | 2.466,94 | 2.561,98 | 2.921,49 |

#### JUNE. Chaise longue.

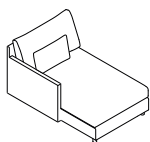

#### JUNCLI105BE

105 x 160 H87  
41.34" x 62.99" H34.25"  
IZQ.

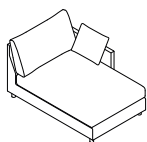

#### JUNCLD105BE

105 x 160 H87  
41.34" x 62.99" H34.25"  
DER.

| MEASUREMENT. MESURE. MEDIDA.            | REF.                      | M.L. | COM / COL | 1        | 2        | 3        | 4        | 5        | L1       | L2       |
|---|---------------------------|------|-----------|----------|----------|----------|----------|----------|----------|----------|
| 105 x 160 H87   41.33" x 62.99" H34.25" | JUNCLI105BE - JUNCLD105BE | 7.5  | 1.561,98  | 1.652,89 | 1.772,73 | 1.880,17 | 2.123,97 | 2.599,17 | 2.694,21 | 3.132,23 |

#### JUNE. Ottoman. Pouf. Ottoman.

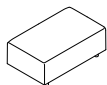

#### JUNP115

115 x 70 H45  
45.28" x 27.56" H17.72"

| MEASUREMENT. MESURE. MEDIDA.           | REF.    | M.L. | COM / COL | 1      | 2      | 3      | 4      | 5      | L1       | L2       |
|--|---------|------|-----------|--------|--------|--------|--------|--------|----------|----------|
| 115 x 70 H45   45.27" x 27.55" H17.71" | JUNP115 | 2.5  | 599,17    | 669,42 | 685,95 | 731,40 | 801,65 | 966,94 | 1.004,13 | 1.152,89 |

# JUNE.

# SOFA. CANAPÉ. SOFÁ.



STYLE. ESTILO.  
Essential

VERSION. VERSIÓN.  
Wide arm version. Version à bras large. Version de brazo ancho. (16 cm - 6.3 in)

## FEATURES. TRAITS. CARACTERÍSTICAS.

---

Completely removable upholstery.  
In leather, seat, back and auxiliary  
cushions with removable covers.

Wooden frame covered with flexible  
cold shaped polyurethane foam and  
polyester fibre.

Suspension consisting of elasticated  
webbing in different tensions.

Seat cushions made with  
polyurethane foam inserts,  
padded with fibre and washed,  
sterilised down. Back cushions with  
polyurethane foam insert, padded  
with fibre and washed, sterilised  
down. Auxiliary cushions with  
polyurethane foam insert, padded  
with fibre and washed, sterilised  
down.

Metal feet coated with polyester  
powder paint and a manganese  
topcoat, with LDPE stops.

Tapiserie entièrement déhoussable.  
En cuir, coussins de l'assise, du  
dossier et auxiliaires déhoussables.

Cadre en bois recouvert de mousse  
de polyuréthane souple à froid et de  
fibre de polyester.

Suspension au moyen de sangles  
élastiques entrelacées de différentes  
tensions.

Coussins de l'assise garnis de  
mousse polyuréthane, matelassés  
avec de la fibre et des plumes lavées  
et stérilisées. Coussins du dossier  
garnis de fibre de polyester et  
plumes lavées et stérilisées. Coussins  
auxiliaires garnis de fibre de polyester  
et plumes lavées et stérilisées.

Pieds métalliques recouverts en  
peinture polyester en poudre finition  
manganèse avec butées en PEBD.

Tapicería totalmente desenfundable.  
En piel, cojines de asiento, cojines  
de respaldo y cojines auxiliares  
desenfundables.

Bastidor de madera recubierto de  
espuma de poliuretano flexible en frío  
y fibra de poliéster.

Suspensión mediante cinchas  
elásticas entrelazadas de diferentes  
tensiones.

Cojines de asiento realizados con  
inserto de espuma de poliuretano,  
acolchado con fibra y pluma lavada  
y esterilizada. Cojines de respaldo  
reellenos de fibra de poliéster  
y pluma lavada y esterilizada.  
Cojines auxiliares reellenos de fibra  
de poliéster y pluma lavada y  
esterilizada.

Patas metálicas recubiertas en  
pintura poliéster en polvo acabado  
manganeso con topes de LDPE.

## JUNE.

### GENERAL MEASUREMENTS. MESURES GÉNÉRALES. MEDIDAS GENERALES.

---

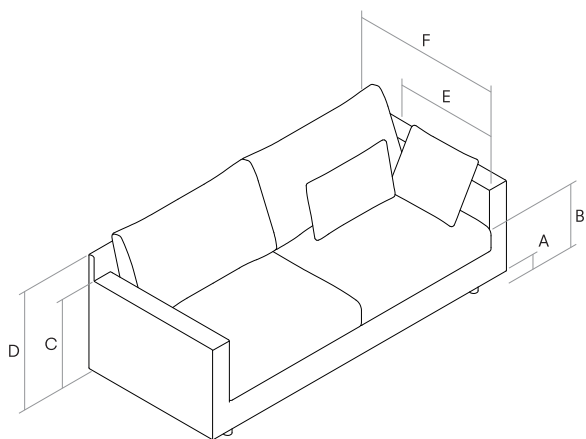

- A.** Base height. Hauteur de base. Altura de base. 10 cm - 3.94"
- B.** Seat height. Hauteur du siège. Altura de asiento. 45 cm - 17.72"
- C.** Arm height. Hauteur des bras. Altura de brazo. 61 cm - 24.02"
- D.** Backrest height. Hauteur du dossier. Altura de respaldo. 87 cm - 34.25"
- E.** Seat depth. Profondeur d'assise. Profundidad de asiento. 60 cm - 23.62"
- F.** Depth. Profondeur. Profundidad. 95 cm - 37.40"

### FINISHES. TRAITS. ACABADOS.

---

Finishes for the metal feet. Finitions des pieds métalliques. Acabados de las patas metálicas.

---

Polyester powder paint. Peinture polyester en poudre. Pintura poliéster en polvo.

---



Manganese metal.  
Métal manganèse.  
Metal manganeso.

## JUNE.

### PRICES. PRIX. PRECIOS.

#### JUNE. Sofa. Canapé. Sofá.

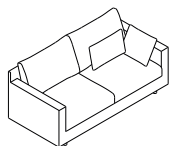

**JUNS210BA**

210 x 95 H87  
74.80" x 37.40" H34.25"

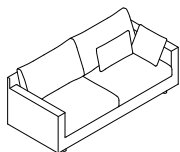

**JUNS230BA**

230 x 95 H87  
82.68" x 37.40" H34.25"

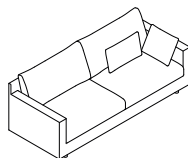

**JUNS250BA**

250 x 95 H87  
90.55" x 37.40" H34.25"

| MEASUREMENT. MESURE. MEDIDA.           | REF.      | M.L. | COM / COL | 1        | 2        | 3        | 4        | 5        | L1       | L2       |
|--|-----------|------|-----------|----------|----------|----------|----------|----------|----------|----------|
| 210 x 95 H87   82.67" x 37.40" H34.25" | JUNS210BA | 9.5  | 1.913,22  | 2.012,40 | 2.177,69 | 2.297,52 | 2.607,44 | 3.177,69 | 3.289,26 | 3.805,79 |
| 230 x 95 H87   90.55" x 37.40" H34.25" | JUNS230BA | 10   | 1.983,47  | 2.090,91 | 2.247,93 | 2.380,17 | 2.677,69 | 3.272,73 | 3.392,56 | 3.962,81 |
| 250 x 95 H87   98.43" x 37.40" H34.25" | JUNS250BA | 10.5 | 2.177,69  | 2.297,52 | 2.458,68 | 2.607,44 | 2.921,49 | 3.570,25 | 3.694,21 | 4.260,33 |

#### JUNE. Sofa with 1 arm. Canapé avec 1 accoudoir. Sofá con 1 brazo.

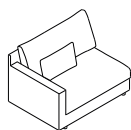

**JUNS1135BA**

135 x 95 H87  
49.21" x 37.40" H34.25"  
IZQ.



**JUNS1195BA**

195 x 95 H87  
72.83" x 37.40" H34.25"  
IZQ.

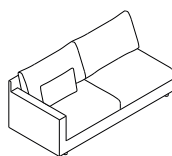

**JUNS1215BA**

215 x 95 H87  
80.71" x 37.40" H34.25"  
IZQ.

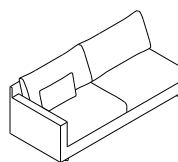

**JUNS1235BA**

235 x 95 H87  
88.58" x 37.40" H34.25"  
IZQ.

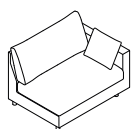

**JUNSD135BA**

135 x 95 H87  
49.21" x 37.40" H34.25"  
DER.

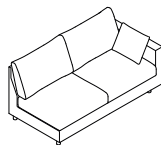

**JUNSD195BA**

195 x 95 H87  
72.83" x 37.40" H34.25"  
DER.

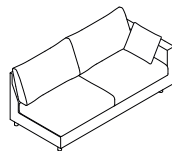

**JUNSD215BA**

215 x 95 H87  
80.71" x 37.40" H34.25"  
DER.

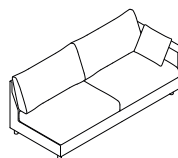

**JUNSD235BA**

235 x 95 H87  
88.58" x 37.40" H34.25"  
DER.

| MEASUREMENT. MESURE. MEDIDA.           | REF.                    | M.L. | COM / COL | 1        | 2        | 3        | 4        | 5        | L1       | L2       |
|--|-------------------------|------|-----------|----------|----------|----------|----------|----------|----------|----------|
| 135 x 95 H87   53.15" x 37.40" H34.25" | JUNS1135BA - JUNSD135BA | 6.5  | 1.342,98  | 1.404,96 | 1.491,74 | 1.561,98 | 1.731,40 | 2.061,98 | 2.123,97 | 2.500,00 |
| 195 x 95 H87   76.77" x 37.40" H34.25" | JUNS1195BA - JUNSD195BA | 8.5  | 1.731,40  | 1.826,45 | 1.942,15 | 2.070,25 | 2.297,52 | 2.805,79 | 2.921,49 | 3.334,71 |
| 215 x 95 H87   84.65" x 37.40" H34.25" | JUNS1215BA - JUNSD215BA | 9    | 1.793,39  | 1.904,96 | 2.028,93 | 2.177,69 | 2.421,49 | 2.954,55 | 3.061,98 | 3.524,79 |
| 235 x 95 H87   92.52" x 37.40" H34.25" | JUNS1235BA - JUNSD235BA | 10   | 1.975,21  | 2.090,91 | 2.185,95 | 2.326,45 | 2.607,44 | 3.243,80 | 3.272,73 | 3.867,77 |



## JUNE.

PRICES. PRIX. PRECIOS.

### JUNE. Corner. Angle. Rincón.

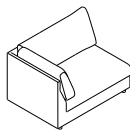

#### JUNRI135

135 x 95 H87  
53.15" x 37.40" H34.25"  
IZQ.

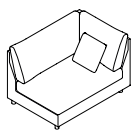

#### JUNRD135

135 x 95 H87  
53.15" x 37.40" H34.25"  
DER.

| MEASUREMENT. MESURE. MEDIDA.           | REF.                | M.L. | COM / COL | 1        | 2        | 3        | 4        | 5        | L1       | L2       |
|--|---------------------|------|-----------|----------|----------|----------|----------|----------|----------|----------|
| 135 x 95 H87   53.14" x 37.40" H34.25" | JUNRI135 - JUNRD135 | 7    | 1.520,66  | 1.599,17 | 1.710,74 | 1.801,65 | 2.028,93 | 2.466,94 | 2.561,98 | 2.921,49 |

### JUNE. Chaise longue.

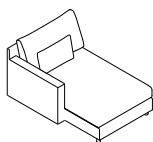

#### JUNCLI115BA

115 x 160 H87  
41.34" x 62.99" H34.25"  
IZQ.

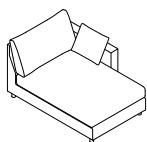

#### JUNCLD115BA

115 x 160 H87  
41.34" x 62.99" H34.25"  
DER.

| MEASUREMENT. MESURE. MEDIDA.            | REF.                      | M.L. | COM / COL | 1        | 2        | 3        | 4        | 5        | L1       | L2       |
|---|---------------------------|------|-----------|----------|----------|----------|----------|----------|----------|----------|
| 115 x 160 H87   45.28" x 62.99" H34.25" | JUNCLI115BA - JUNCLD115BA | 8    | 1.599,17  | 1.793,39 | 1.793,39 | 1.913,22 | 2.140,50 | 2.623,97 | 2.710,74 | 3.132,23 |

### JUNE. Open corner. Angle ouvert. Rincón abierto.

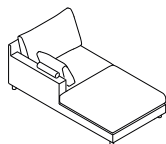

#### JUNRAI105BA

105 x 225 H87  
45.28" x 88.58" H34.25"  
IZQ.

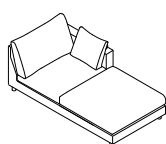

#### JUNRAD105BA

105 x 225 H87  
45.28" x 88.58" H34.25"  
DER.

| MEASUREMENT. MESURE. MEDIDA.            | REF.                      | M.L. | COM / COL | 1        | 2        | 3        | 4        | 5        | L1       | L2       |
|---|---------------------------|------|-----------|----------|----------|----------|----------|----------|----------|----------|
| 105 x 225 H87   41.33" x 88.58" H34.25" | JUNRAI105BA - JUNRAD105BA | 12   | 1.983,47  | 2.066,12 | 2.181,82 | 2.293,39 | 2.541,32 | 2.995,87 | 3.090,91 | 3.752,07 |

JUNE.

PRICES. PRIX. PRECIOS.

---

JUNE. Ottoman. Pouf. Ottoman.

---

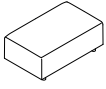

**JUNP115**

115 x 70 H45

45.28" x 27.56" H17.72"

| MEASUREMENT. MESURE. MEDIDA.           | REF.    | M.L. | COM / COL | 1      | 2      | 3      | 4      | 5      | L1       | L2       |
|--|---------|------|-----------|--------|--------|--------|--------|--------|----------|----------|
| 115 x 70 H45   45.27" x 27.55" H17.71" | JUNP115 | 2.5  | 599,17    | 669,42 | 685,95 | 731,40 | 801,65 | 966,94 | 1.004,13 | 1.152,89 |



# MAGNUS.

# SOFA. CANAPÉ. SOFÁ.



Designer  
Mario Ruiz

STYLE. ESTILO.  
New Classic

VERSION. VERSIÓN.  
Visible base version. Version base visible. Versión base visible.

## FEATURES. TRAITS. CARACTERÍSTICAS.

---

Completely removable upholstery. In leather, seat and back cushions with removable covers.

Wooden frame covered with flexible cold shaped polyurethane foam and polyester fibre.

Suspension consisting of elasticated webbing in different tensions. Seat cushion made with polyurethane foam inserts, padded with fibre and washed, sterilised down. Back cushions stuffed with polyester fibre and washed, sterilised down.

Metal bases coated with polyester powder paint and a manganese topcoat with LDPE stops or solid oak feet.

Tapiserie entièrement déhoussable. En cuir, coussin de l'assise et coussins du dossier déhoussables.

Cadre en bois recouvert de mousse de polyuréthane souple à froid et de fibre de polyester.

Suspension au moyen de sangles élastiques entrelacées de différentes tensions.

Coussin de l'assise garni de mousse polyuréthane, matelassé avec de la fibre et des plumes lavées et stérilisées. Coussins du dossier garnis de fibre de polyester et plumes lavées et stérilisées.

Bases métalliques recouverts en peinture polyester en poudre finition manganèse avec butées en PEBD ou pieds en chêne massif.

Tapicería totalmente desenfundable. En piel, cojín de asiento y respaldos desenfundables.

Bastidor de madera recubierto de espuma de poliuretano flexible en frío y fibra de poliéster

Suspensión mediante cinchas elásticas entrelazadas de diferentes tensiones.

Cojín de asiento realizado con inserto de espuma de poliuretano, acolchado con fibra y pluma lavada y esterilizada. Cojines de respaldo rellenos de fibra de poliéster y pluma lavada y esterilizada.

Bases metálicas recubiertas en pintura poliéster en polvo acabado manganeso con topes de LDPE o pies en roble macizo.

## MACNUS.

### GENERAL MEASUREMENTS. MESURES GÉNÉRALES. MEDIDAS GENERALES.

---

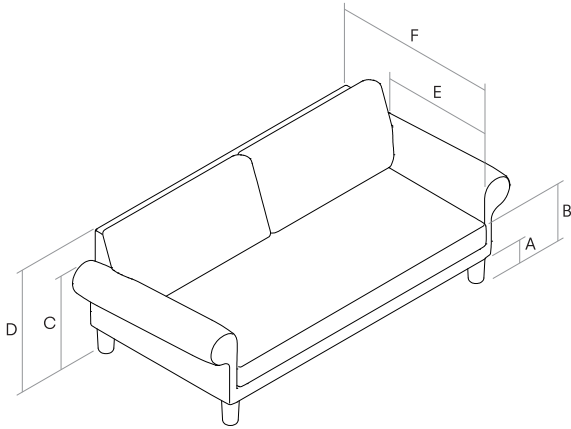

- A. Base height. Hauteur de la base. Altura de la pata. 15 cm - 5.91"
- B. Seat height. Hauteur du siège. Altura de asiento. 44 cm - 17.32"
- C. Arm height. Hauteur du bras. Altura de brazo. 61 cm - 24.02"
- D. Backrest height. Hauteur du dossier. Altura de respaldo. 81 cm - 31.89"
- E. Seat depth. Profondeur d'assise. Profundidad de sentada. 62 cm - 24.41"
- F. Depth. Profondeur. Profundidad. 98 cm - 38.58"

### FINISHES. TRAITS. ACABADOS.

---

Finishes for the metal bases. Finitions des pieds métalliques. Acabados de las patas metálicas.

---

Polyester powder paint. Peinture polyester en poudre. Pintura poliéster en polvo.

---



Manganese metal.  
Métal manganèse.  
Metal manganeso.

Finishes for the wooden feet. Finitions des pieds en bois. Acabados de los pies en madera.

---

Wood finishes. Finitions bois. Acabado de la madera.

---



Natural oak.  
Chêne naturel.  
Roble natural.



**RT**  
Dark stained oak.  
Chêne teint foncée.  
Roble teñido oscuro.



**RL**  
Oak painted in black with open-pore finish.  
Chêne laqué noir à pores ouverts.  
Roble lacado negro por abierto.

### OPTIONAL BASES. PIEDS EN OPTION. PATAS OPCIONALES.

---

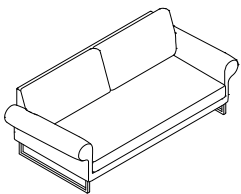

Metal bases. Pieds métalliques. Patas metálicas.

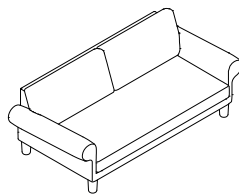

Solid oak feet. Pieds en chêne massif.  
Pies en roble macizo.

## MAGNUS.

### PRICES. PRIX. PRECIOS.

#### MAGNUS. Sofa. Canapé. Sofá.

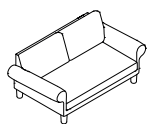

**MAGS162**  
162 x 98 H81  
63.78" x 38.58" H31.89"

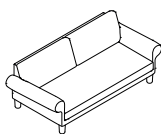

**MAGS197**  
197 x 98 H81  
77.56" x 38.58" H31.89"

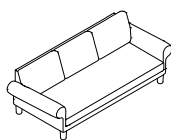

**MAGS212**  
212 x 98 H81  
83.46" x 38.58" H31.89"

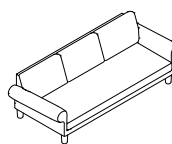

**MAGS232**  
232 x 98 H81  
91.34" x 38.58" H31.89"

| MEASUREMENT. MESURE. MEDIDA.           | REF.    | M.L. | COM / COL | 1        | 2        | 3        | 4        | 5        | L1       | L2       |
|--|---------|------|-----------|----------|----------|----------|----------|----------|----------|----------|
| 162 x 98 H81   63.77" x 38.58" H31.88" | MAGS162 | 7.5  | 2.404,96  | 2.520,66 | 2.619,83 | 2.735,54 | 2.987,60 | 3.442,15 | 3.537,19 | 3.929,75 |
| 197 x 98 H81   77.55" x 38.58" H31.88" | MAGS197 | 9    | 2.690,08  | 2.789,26 | 2.942,15 | 3.103,31 | 3.388,43 | 3.958,68 | 4.082,64 | 4.582,64 |
| 212 x 98 H81   83.46" x 38.58" H31.88" | MAGS212 | 9    | 2.826,45  | 2.942,15 | 3.066,12 | 3.227,27 | 3.537,19 | 4.111,57 | 4.227,27 | 4.760,33 |
| 232 x 98 H81   91.33" x 38.58" H31.88" | MAGS232 | 10.5 | 3.004,13  | 3.144,63 | 3.334,71 | 3.495,87 | 3.834,71 | 4.520,66 | 4.652,89 | 5.252,07 |

#### MAGNUS. Sofa with 1 arm. Canapé avec 1 accoudoir. Sofá con 1 brazo.

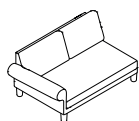

**MAGSI151**  
151 x 98 H81  
59.45" x 38.58" H31.89"  
IZQ.

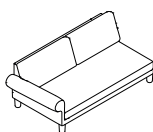

**MAGSI186**  
186 x 98 H81  
73.23" x 38.58" H31.89"  
IZQ.

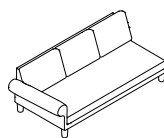

**MAGSI201**  
201 x 98 H81  
79.13" x 38.58" H31.89"  
IZQ.

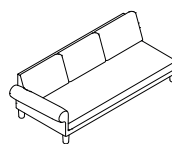

**MAGSI225**  
225 x 98 H81  
88.58" x 38.58" H31.89"  
IZQ.

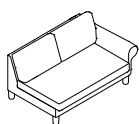

**MAGSD151**  
151 x 98 H81  
59.45" x 38.58" H31.89"  
DER.

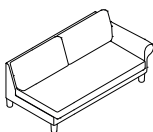

**MAGSD186**  
186 x 98 H81  
73.23" x 38.58" H31.89"  
DER.

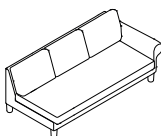

**MAGSD201**  
201 x 98 H81  
79.13" x 38.58" H31.89"  
DER.

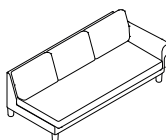

**MAGSD225**  
225 x 98 H81  
88.58" x 38.58" H31.89"  
DER.

| MEASUREMENT. MESURE. MEDIDA.           | REF.                | M.L. | COM / COL | 1        | 2        | 3        | 4        | 5        | L1       | L2       |
|--|---------------------|------|-----------|----------|----------|----------|----------|----------|----------|----------|
| 151 x 98 H81   59.44" x 38.58" H31.88" | MAGSI151 - MAGSD151 | 6    | 2.243,80  | 2.289,26 | 2.404,96 | 2.495,87 | 2.690,08 | 3.066,12 | 3.144,63 | 3.475,21 |
| 186 x 98 H81   73.22" x 38.58" H31.88" | MAGSI186 - MAGSD186 | 8    | 2.404,96  | 2.520,66 | 2.665,29 | 2.789,26 | 3.037,19 | 3.537,19 | 3.636,36 | 4.103,31 |
| 201 x 98 H81   79.13" x 38.58" H31.88" | MAGSI201 - MAGSD201 | 8    | 2.619,83  | 2.727,27 | 2.842,98 | 2.987,60 | 3.235,54 | 3.743,80 | 3.859,50 | 4.305,79 |
| 225 x 98 H81   88.58" x 38.58" H31.88" | MAGSI225 - MAGSD225 | 9.5  | 2.826,45  | 2.942,15 | 3.103,31 | 3.235,54 | 3.537,19 | 4.144,63 | 4.272,73 | 4.805,79 |

## MAGNUS.

### PRICES. PRIX. PRECIOS.

#### MAGNUS. Corner. Angle. Rincón.

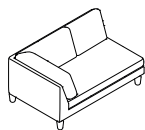

#### MAGRI161

161 x 98 H81  
63.39" x 38.58" H31.89"  
IZQ.

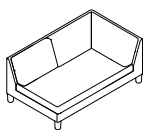

#### MAGRD161

161 x 98 H81  
63.39" x 38.58" H31.89"  
DER.

| MEASUREMENT. MESURE. MEDIDA.           | REF.                | M.L. | COM / COL | 1        | 2        | 3        | 4        | 5        | L1       | L2       |
|--|---------------------|------|-----------|----------|----------|----------|----------|----------|----------|----------|
| 161 x 98 H81   63.38" x 38.58" H31.88" | MAGRI161 - MAGRD161 | 7.7  | 2.698,35  | 2.789,26 | 2.913,22 | 3.037,19 | 3.260,33 | 3.760,33 | 3.859,50 | 4.297,52 |

#### MAGNUS. Chaise longue.

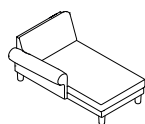

#### MAGCLI100

100 x 161 H81  
39.37" x 63.39" H31.89"  
IZQ.

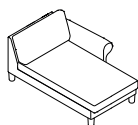

#### MAGCLD100

100 x 161 H81  
39.37" x 63.39" H31.89"  
DER.

| MEASUREMENT. MESURE. MEDIDA.            | REF.                  | M.L. | COM / COL | 1        | 2        | 3        | 4        | 5        | L1       | L2       |
|---|-----------------------|------|-----------|----------|----------|----------|----------|----------|----------|----------|
| 100 x 161 H81   39.37" x 63.38" H31.88" | MAGCLI100 - MAGCLD100 | 6.5  | 2.495,87  | 2.582,64 | 2.698,35 | 2.797,52 | 3.004,13 | 3.450,41 | 3.520,66 | 3.904,96 |

#### MAGNUS. Ottomans. Poufs. Ottomans.

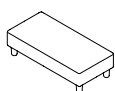

#### MAGP66

66 x 137 H36  
25.98" x 53.94" H14.17"

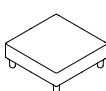

#### MAGP98

98 x 98 H36  
38.58" x 38.58" H14.17"

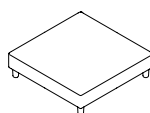

#### MAGP137

137 x 137 H36  
53.94" x 53.94" H14.17"

| MEASUREMENT. MESURE. MEDIDA.            | REF.    | M.L. | COM / COL | 1        | 2        | 3        | 4        | 5        | L1       | L2       |
|---|---------|------|-----------|----------|----------|----------|----------|----------|----------|----------|
| 66 x 137 H36   25.98" x 53.93" H14.17"  | MAGP66  | 1.5  | 913,22    | 933,88   | 966,94   | 987,60   | 1.041,32 | 1.136,36 | 1.148,76 | 1.243,80 |
| 98 x 98 H36   38.58" x 38.58" H14.17"   | MAGP98  | 2    | 871,90    | 913,22   | 933,88   | 966,94   | 1.020,66 | 1.148,76 | 1.165,29 | 1.264,46 |
| 137 x 137 H36   53.93" x 53.93" H14.17" | MAGP137 | 2.5  | 1.136,36  | 1.148,76 | 1.181,82 | 1.243,80 | 1.305,79 | 1.487,60 | 1.504,13 | 1.648,76 |

# MAGNUS.

# SOFA. CANAPÉ. SOFÁ.



Designer  
Mario Ruiz

STYLE. ESTILO.  
New Classic

VERSION. VERSIÓN.  
Fabric cover version. Version jupe. Versión base faldón.

## FEATURES. TRAITS. CARACTERÍSTICAS.

---

Completely removable upholstery.  
Not available in leather.

Wooden frame covered with flexible cold shaped polyurethane foam and polyester fibre.

Suspension consisting of elasticated webbing in different tensions.

Seat cushion made with polyurethane foam inserts, padded with fibre and washed, sterilised down. Back cushions stuffed with polyester fibre and washed, sterilised down.

Metal bases coated with polyester powder paint and a manganese topcoat with LDPE stops or solid oak feet.

Tapiserie entièrement déhoussable.  
Non-disponible en cuir.

Cadre en bois recouvert de mousse de polyuréthane souple à froid et de fibre de polyester.

Suspension au moyen de sangles élastiques entrelacées de différentes tensions.

Coussin de l'assise garnis de mousse polyuréthane, matelassé avec de la fibre et des plumes lavées et stérilisées. Coussins du dossier garnis de fibre de polyester et plumes lavées et stérilisées.

Bases métalliques recouverts en peinture polyester en poudre finition manganèse avec butées en PEBD ou pieds en chêne massif.

Tapicería totalmente desenfundable.  
No disponible en piel.

Bastidor de madera recubierto de espuma de poliuretano flexible en frío y fibra de poliéster.

Suspensión mediante cinchas elásticas entrelazadas de diferentes tensiones.

Cojín de asiento realizado con inserto de espuma de poliuretano, acolchado con fibra y pluma lavada y esterilizada. Cojines de respaldo rellenos de fibra de poliéster y pluma lavada y esterilizada.

Bases metálicas recubiertas en pintura poliéster en polvo acabado manganeso con topes de LDPE o pies en roble macizo.



## MACNUS.

### GENERAL MEASUREMENTS. MESURES GÉNÉRALES. MEDIDAS GENERALES.

---

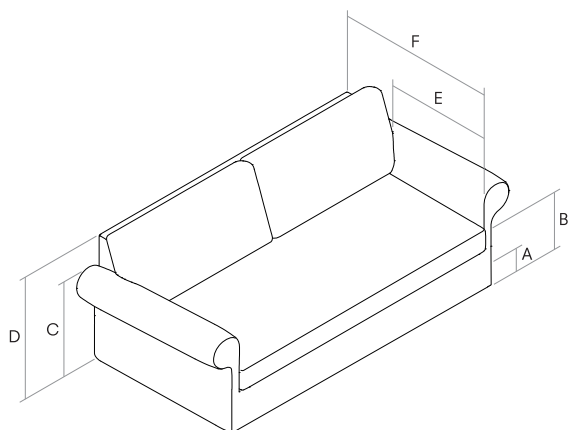

- A. Base height. Hauteur de la base. Altura de la pata. 15 cm - 5.91"
- B. Seat height. Hauteur du siège. Altura de asiento. 44 cm - 17.32"
- C. Arm height. Hauteur du bras. Altura de brazo. 61 cm - 24.02"
- D. Backrest height. Hauteur du dossier. Altura de respaldo. 81 cm - 31.89"
- E. Seat depth. Profondeur d'assise. Profundidad de sentada. 62 cm - 24.41"
- F. Depth. Profondeur. Profundidad. 98 cm - 38.58"

### FINISHES. TRAITS. ACABADOS.

---

Finishes for the metal bases. Finitions des pieds métalliques. Acabados de las patas metálicas.

---

Polyester powder paint. Peinture polyester en poudre. Pintura poliéster en polvo.

---



Manganese metal.  
Métal manganèse.  
Metal manganeso.

Finishes for the wooden feet. Finitions des pieds en bois. Acabados de los pies en madera.

---

Wood finishes. Finitions bois. Acabado de la madera.

---



Natural oak.  
Chêne naturel.  
Roble natural.

## MAGNUS.

PRICES. PRIX. PRECIOS.

MAGNUS. Sofa. Canapé. Sofá.

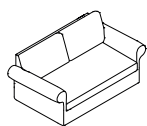

**MAGS162FA**

162 x 98 H81  
63.78" x 38.58" H31.89"

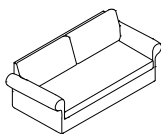

**MAGS197FA**

197 x 98 H81  
77.56" x 38.58" H31.89"

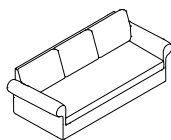

**MAGS212FA**

212 x 98 H81  
83.46" x 38.58" H31.89"

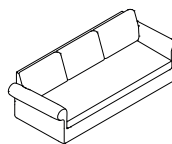

**MAGS232FA**

232 x 98 H81  
91.34" x 38.58" H31.89"

| MEASUREMENT. MESURE. MEDIDA.           | REF.      | M.L. | COM / COL | 1        | 2        | 3        | 4        | 5        |
|--|-----------|------|-----------|----------|----------|----------|----------|----------|
| 162 x 98 H81   63.77" x 38.58" H31.88" | MAGS162FA | 9.5  | 2.388,43  | 2.495,87 | 2.665,29 | 2.789,26 | 3.103,31 | 3.690,08 |
| 197 x 98 H81   77.55" x 38.58" H31.88" | MAGS197FA | 10   | 2.574,38  | 2.603,31 | 2.880,17 | 3.012,40 | 3.334,71 | 3.958,68 |
| 212 x 98 H81   83.46" x 38.58" H31.88" | MAGS212FA | 10   | 2.710,74  | 2.842,98 | 3.004,13 | 3.181,82 | 3.475,21 | 4.111,57 |
| 232 x 98 H81   91.33" x 38.58" H31.88" | MAGS232FA | 11   | 2.942,15  | 3.066,12 | 3.252,07 | 3.450,41 | 3.780,99 | 4.512,40 |

MAGNUS. Sofa with 1 arm. Canapé avec 1 accoudoir. Sofá con 1 brazo.

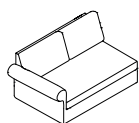

**MAGS1151FA**

151 x 98 H81  
59.45" x 38.58" H31.89"  
IZQ.

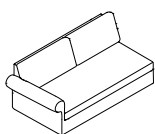

**MAGS1186FA**

186 x 98 H81  
73.23" x 38.58" H31.89"  
IZQ.

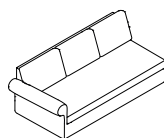

**MAGS1201FA**

201 x 98 H81  
79.13" x 38.58" H31.89"  
IZQ.

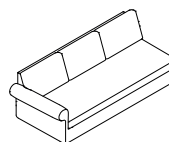

**MAGS1225FA**

225 x 98 H81  
88.58" x 38.58" H31.89"  
IZQ.

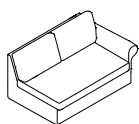

**MAGSD1151FA**

151 x 98 H81  
59.45" x 38.58" H31.89"  
DER.

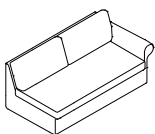

**MAGSD1186FA**

186 x 98 H81  
73.23" x 38.58" H31.89"  
DER.

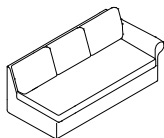

**MAGSD1201FA**

201 x 98 H81  
79.13" x 38.58" H31.89"  
DER.

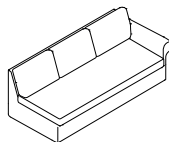

**MAGSD1225FA**

225 x 98 H81  
88.58" x 38.58" H31.89"  
DER.

| MEASUREMENT. MESURE. MEDIDA.           | REF.                     | M.L. | COM / COL | 1        | 2        | 3        | 4        | 5        |
|--|--------------------------|------|-----------|----------|----------|----------|----------|----------|
| 151 x 98 H81   59.44" x 38.58" H31.88" | MAGS1151FA - MAGSD1151FA | 6.5  | 2.165,29  | 2.243,80 | 2.334,71 | 2.450,41 | 2.665,29 | 3.066,12 |
| 186 x 98 H81   73.22" x 38.58" H31.88" | MAGS1186FA - MAGSD1186FA | 8.5  | 2.351,24  | 2.466,94 | 2.603,31 | 2.735,54 | 3.037,19 | 3.611,57 |
| 201 x 98 H81   79.13" x 38.58" H31.88" | MAGS1201FA - MAGSD1201FA | 9    | 2.549,59  | 2.665,29 | 2.797,52 | 2.958,68 | 3.227,27 | 3.805,79 |
| 225 x 98 H81   88.58" x 38.58" H31.88" | MAGS1225FA - MAGSD1225FA | 10.5 | 2.735,54  | 2.867,77 | 3.037,19 | 3.198,35 | 3.537,19 | 4.190,08 |

## MAGNUS.

PRICES. PRIX. PRECIOS.

### MAGNUS. Corner. Angle. Rincón.

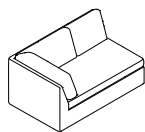

#### MAGR161FA

161 x 98 H81  
63.39" x 38.58" H31.89"  
IZQ.

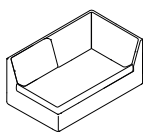

#### MAGRD161FA

161 x 98 H81  
63.39" x 38.58" H31.89"  
DER.

| MEASUREMENT. MESURE. MEDIDA.           | REF.                   | M.L. | COM / COL | 1        | 2        | 3        | 4        | 5        |
|--|------------------------|------|-----------|----------|----------|----------|----------|----------|
| 161 x 98 H81   63.38" x 38.58" H31.88" | MAGR161FA - MAGRD161FA | 8.5  | 2.289,26  | 2.404,96 | 2.541,32 | 2.690,08 | 2.950,41 | 3.475,21 |

### MAGNUS. Chaise longue.

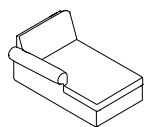

#### MAGCLI100FA

100 x 161 H81  
39.37" x 63.39" H31.89"  
IZQ.

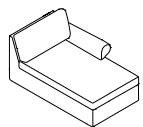

#### MAGCLD100FA

100 x 161 H81  
39.37" x 63.39" H31.89"  
DER.

| MEASUREMENT. MESURE. MEDIDA.            | REF.                      | M.L. | COM / COL | 1        | 2        | 3        | 4        | 5        |
|---|---------------------------|------|-----------|----------|----------|----------|----------|----------|
| 100 x 161 H81   39.37" x 63.38" H31.88" | MAGCLI100FA - MAGCLD100FA | 8    | 2.041,32  | 2.128,10 | 2.243,80 | 2.351,24 | 2.582,64 | 3.090,91 |

### MAGNUS. Ottomans. Poufs. Ottomans.

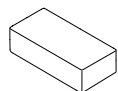

#### MAGP66FA

66 x 137 H36  
25.98" x 53.94" H14.17"

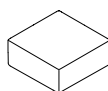

#### MAGP98FA

98 x 98 H36  
38.58" x 38.58" H14.17"

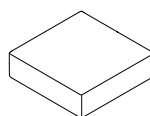

#### MAGP137FA

137 x 137 H36  
53.94" x 53.94" H14.17"

| MEASUREMENT. MESURE. MEDIDA.            | REF.      | M.L. | COM / COL | 1        | 2        | 3        | 4        | 5        |
|---|-----------|------|-----------|----------|----------|----------|----------|----------|
| 66 x 137 H36   25.98" x 53.93" H14.17"  | MAGP66FA  | 2    | 826,45    | 851,24   | 871,90   | 913,22   | 987,60   | 1.128,10 |
| 98 x 98 H36   38.58" x 38.58" H14.17"   | MAGP98FA  | 2.5  | 871,90    | 904,96   | 933,88   | 966,94   | 1.020,66 | 1.136,36 |
| 137 x 137 H36   53.93" x 53.93" H14.17" | MAGP137FA | 3    | 1.095,04  | 1.148,76 | 1.181,82 | 1.202,48 | 1.305,79 | 1.487,60 |



STYLE. ESTILO.  
Essential

VERSION. VERSIÓN.  
Polyurethane seat cushions. Coussin d'assise en polyuréthane. Cojín de asiento de poliuretano.

## FEATURES. TRAITS. CARACTERÍSTICAS.

Completely removable upholstery. In leather, seat and back cushions with removable covers.

Wooden frame covered with flexible cold shaped polyurethane foam and polyester fibre.

Suspension consisting of elasticated webbing in different tensions.

Seat cushions in different polyurethane foam densities, with surface padding in fibre. Back cushions stuffed with polyester fibre and washed, sterilised down.

Metal bases coated with polyester powder paint and a manganese topcoat with LDPE stops.

**The default seating option is polyurethane foam.**

Tapiserie entièrement déhoussable. En cuir, coussin de l'assise et coussins du dossier déhoussables.

Cadre en bois recouvert de mousse de polyuréthane souple à froid et de fibre de polyester.

Suspension au moyen de sangles élastiques entrelacées de différentes tensions.

Coussins d'assise en mousse de polyuréthane de différentes densités, rembourrés en surface avec de la fibre. Coussins du dossier garnis de fibre de polyester et plumes lavées et stérilisées.

Bases métalliques recouvertes en peinture polyester en poudre finition manganèse avec butées en PEBD.

**L'option d'assise par défaut est la mousse de polyuréthane.**

Tapicería totalmente desenfundable. En piel, cojín de asiento y respaldos desenfundables.

Bastidor de madera recubierto de espuma de poliuretano flexible en frío y fibra de poliéster

Suspensión mediante cinchas elásticas entrelazadas de diferentes tensiones.

Cojines de asiento realizados en distintas densidades de espuma de poliuretano, acolchado en la superficie con fibra. Cojines de respaldo rellenos de fibra de poliéster y pluma lavada y esterilizada.

Patas metálicas recubiertas en pintura poliéster en polvo acabado manganeso con topes de LDPE.

**La opción por defecto en los asientos es la de espuma de poliuretano.**

## PARK.

### GENERAL MEASUREMENTS. MESURES GÉNÉRALES. MEDIDAS GENERALES.

---

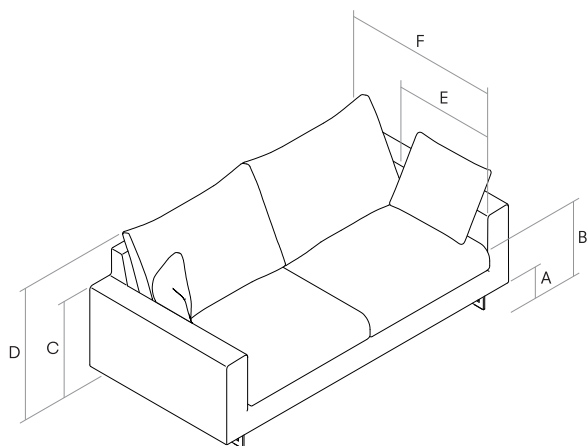

- A. Base height. Hauteur de la base. Altura de base. 10 cm - 3.94"
- B. Seat height. Hauteur du siège. Altura de asiento. 42 cm - 16.54"
- C. Arm height. Hauteur du bras. Altura de brazo. 58 cm - 22.83"
- D. Backrest height. Hauteur du dossier. Altura de respaldo. 90 cm - 35.43"
- E. Seat depth. Profondeur d'assise. Profundidad de sentada. 56 cm - 22.05"
- F. Depth. Profondeur. Profundidad. 95 cm - 37.40"

### FINISHES. TRAITS. ACABADOS.

---

Finishes for the metal feet. Finitions des pieds métalliques. Acabados de las patas metálicas.

---

Polyester powder paint. Peinture polyester en poudre. Pintura poliéster en polvo.

---



Manganese metal.  
Métal manganèse.  
Metal manganeso.

## PARK.

### PRICES. PRIX. PRECIOS.

#### PARK. Sofa. Canapé. Sofá.

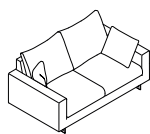

**PARS170VIS**

170 x 95 H90  
66.93" x 37.40" H35.43"

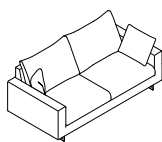

**PARS195VIS**

195 x 95 H90  
76.77" x 37.40" H35.43"

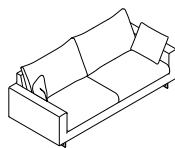

**PARS220VIS**

220 x 95 H90  
86.61" x 37.40" H35.43"

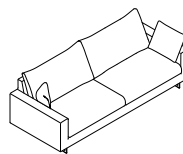

**PARS240VIS**

240 x 95 H90  
94.49" x 37.40" H35.43"

| MEASUREMENT. MESURE. MEDIDA.           | REF.       | M.L. | COM / COL | 1        | 2        | 3        | 4        | 5        | L1       | L2       |
|--|------------|------|-----------|----------|----------|----------|----------|----------|----------|----------|
| 170 x 95 H90   66.92" x 37.40" H35.43" | PARS170VIS | 9    | 1.661,16  | 1.776,86 | 1.871,90 | 2.004,13 | 2.247,93 | 2.731,40 | 2.826,45 | 3.243,80 |
| 195 x 95 H90   76.77" x 37.40" H35.43" | PARS195VIS | 9.5  | 1.805,79  | 1.888,43 | 2.033,06 | 2.152,89 | 2.421,49 | 2.950,41 | 3.045,45 | 3.516,53 |
| 220 x 95 H90   86.61" x 37.40" H35.43" | PARS220VIS | 10   | 1.822,31  | 1.946,28 | 2.078,51 | 2.210,74 | 2.466,94 | 3.024,79 | 3.132,23 | 3.611,57 |
| 240 x 95 H90   94.48" x 37.40" H35.43" | PARS240VIS | 10.5 | 2.033,06  | 2.136,36 | 2.247,93 | 2.421,49 | 2.714,88 | 3.309,92 | 3.404,96 | 3.933,88 |

#### PARK. Sofa with 1 arm. Canapé avec 1 accoudoir. Sofá con 1 brazo.

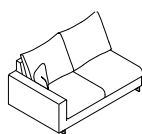

**PARS1155VIS**

155 x 95 H90  
61.02" x 37.40" H35.43"  
IZQ.

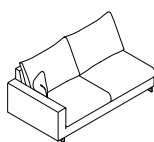

**PARS1180VIS**

180 x 95 H90  
70.87" x 37.40" H35.43"  
IZQ.

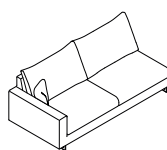

**PARS1205VIS**

205 x 95 H90  
80.71" x 37.40" H35.43"  
IZQ.

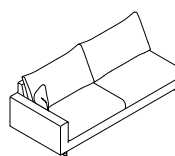

**PARS1225VIS**

225 x 95 H90  
88.58" x 37.40" H35.43"  
IZQ.



**PARSD1155VIS**

155 x 95 H90  
61.02" x 37.40" H35.43"  
DER.

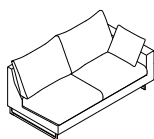

**PARSD1180VIS**

180 x 95 H90  
70.87" x 37.40" H35.43"  
DER.

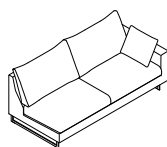

**PARSD1205VIS**

205 x 95 H90  
80.71" x 37.40" H35.43"  
DER.

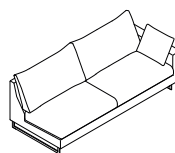

**PARSD1225VIS**

225 x 95 H90  
88.58" x 37.40" H35.43"  
DER.

| MEASUREMENT. MESURE. MEDIDA.           | REF.                       | M.L. | COM / COL | 1        | 2        | 3        | 4        | 5        | L1       | L2       |
|--|----------------------------|------|-----------|----------|----------|----------|----------|----------|----------|----------|
| 155 x 95 H90   61.02" x 37.40" H35.43" | PARS1155VIS - PARSD1155VIS | 8    | 1.500,00  | 1.586,78 | 1.719,01 | 1.822,31 | 2.033,06 | 2.446,28 | 2.524,79 | 2.921,49 |
| 180 x 95 H90   70.86" x 37.40" H35.43" | PARS1180VIS - PARSD1180VIS | 8.5  | 1.636,36  | 1.739,67 | 1.842,98 | 1.983,47 | 2.210,74 | 2.673,55 | 2.780,99 | 3.194,21 |
| 205 x 95 H90   80.70" x 37.40" H35.43" | PARS1205VIS - PARSD1205VIS | 9.5  | 1.776,86  | 1.871,90 | 1.983,47 | 2.099,17 | 2.363,64 | 2.884,30 | 2.987,60 | 3.442,15 |
| 225 x 95 H90   88.58" x 37.40" H35.43" | PARS1225VIS - PARSD1225VIS | 10   | 1.888,43  | 2.004,13 | 2.136,36 | 2.247,93 | 2.533,06 | 3.074,38 | 3.177,69 | 3.640,50 |

**PARK.**

**PRICES. PRIX. PRECIOS.**

PARK. Corner. Angle. Rincón.

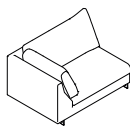

**PARRI135VIS**

135 x 95 H90  
53.15" x 37.40" H35.43"  
IZQ.

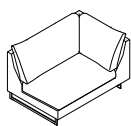

**PARRD135VIS**

135 x 95 H90  
53.15" x 37.40" H35.43"  
DER.

| MEASUREMENT. MESURE. MEDIDA.           | REF.                      | M.L. | COM / COL | 1        | 2        | 3        | 4        | 5        | L1       | L2       |
|--|---------------------------|------|-----------|----------|----------|----------|----------|----------|----------|----------|
| 135 x 95 H90   53.14" x 37.40" H35.43" | PARRI135VIS - PARRD135VIS | 7.5  | 1.438,02  | 1.512,40 | 1.607,44 | 1.702,48 | 1.884,30 | 2.252,07 | 2.347,11 | 2.657,02 |

PARK. Chaise longue.

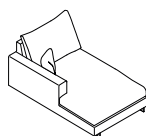

**PARCLI98VIS**

98 x 155 H90  
38.58" x 61.02" H35.43"  
IZQ.

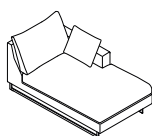

**PARCLD98VIS**

98 x 155 H90  
38.58" x 61.02" H35.43"  
DER.

| MEASUREMENT. MESURE. MEDIDA.           | REF.                      | M.L. | COM / COL | 1        | 2        | 3        | 4        | 5        | L1       | L2       |
|--|---------------------------|------|-----------|----------|----------|----------|----------|----------|----------|----------|
| 98 x 155 H90   38.58" x 61.02" H35.43" | PARCLI98VIS - PARCLD98VIS | 7    | 1.483,47  | 1.570,25 | 1.665,29 | 1.776,86 | 1.966,94 | 2.347,11 | 2.429,75 | 2.760,33 |

PARK. Open corner. Angle ouvert. Rincón abierto.

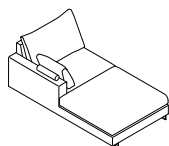

**PARRAI105VIS**

105 x 195 H90  
41.34" x 76.77" H35.43"  
IZQ.

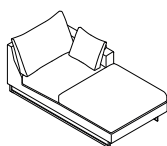

**PARRAD105VIS**

105 x 195 H90  
41.34" x 76.77" H35.43"  
DER.

| MEASUREMENT. MESURE. MEDIDA.            | REF.                        | M.L. | COM / COL | 1        | 2        | 3        | 4        | 5        | L1       | L2       |
|---|-----------------------------|------|-----------|----------|----------|----------|----------|----------|----------|----------|
| 105 x 195 H90   41.33" x 76.77" H35.43" | PARRAI105VIS - PARRAD105VIS | 9    | 1.871,90  | 1.983,47 | 2.099,17 | 2.239,67 | 2.466,94 | 2.979,34 | 3.074,38 | 3.516,53 |

PARK.

PRICES. PRIX. PRECIOS.

---

PARK. Ottomans. Poufs. Ottomans.

---

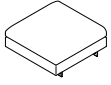

**PARP95VIS**

95 x 95 H42  
37.40"x 37.40" H16.54"

| MEASUREMENT. MESURE. MEDIDA.         | REF.      | M.L. | COM / COL | 1      | 2      | 3      | 4        | 5        | L1       | L2       |
|--------------------------------------|-----------|------|-----------|--------|--------|--------|----------|----------|----------|----------|
| 95 x 95 H42   37.40"x 37.40" H16.53" | PARP95VIS | 3    | 822,31    | 863,64 | 929,75 | 975,21 | 1.024,79 | 1.231,40 | 1.289,26 | 1.487,60 |







STYLE. ESTILO.  
Essential

VERSION. VERSIÓN.  
Polyurethane and feather seat cushions. Coussin d'assise en polyuréthane et plume.  
Cojín de asiento de poliuretano y pluma.

## FEATURES. TRAITS. CARACTERÍSTICAS.

Completely removable upholstery. In leather, seat and back cushions with removable covers.

Wooden frame covered with flexible cold shaped polyurethane foam and polyester fibre.

Suspension consisting of elasticated webbing in different tensions. Seat cushion made with polyurethane foam inserts, padded with fibre and washed, sterilised down. Back cushions stuffed with polyester fibre and washed, sterilised down.

Metal bases coated with polyester powder paint and a manganese topcoat with LDPE stops or solid oak bases.

Tapiserie entièrement déhoussable. En cuir, coussin de l'assise et coussins du dossier déhoussables.

Cadre en bois recouvert de mousse de polyuréthane souple à froid et de fibre de polyester.

Suspension au moyen de sangles élastiques entrelacées de différentes tensions.

Coussin de l'assise garni de mousse polyuréthane, matelassé avec de la fibre et des plumes lavées et stérilisées. Coussins du dossier garnis de fibre de polyester et plumes lavées et stérilisées.

Bases métalliques recouverts en peinture polyester en poudre finition manganèse avec butées en PEBD ou bases en chêne massif.

Tapicería totalmente desenfundable. En piel, cojín de asiento y respaldos desenfundables.

Bastidor de madera recubierto de espuma de poliuretano flexible en frío y fibra de poliéster

Suspensión mediante cinchas elásticas entrelazadas de diferentes tensiones.

Cojín de asiento realizado con inserto de espuma de poliuretano, acolchado con fibra y pluma lavada y esterilizada. Cojines de respaldo rellenos de fibra de poliéster y pluma lavada y esterilizada.

Bases metálicas recubiertas en pintura poliéster en polvo acabado manganeso con topes de LDPE o bases en roble macizo.

## PARK.

### GENERAL MEASUREMENTS. MESURES GÉNÉRALES. MEDIDAS GENERALES.

---

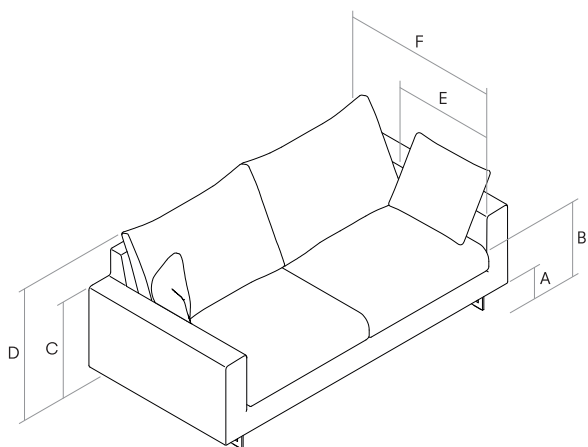

- A.** Base height. Hauteur de base. Altura de base. 10 cm - 3.94"
- B.** Seat height. Hauteur du siège. Altura de asiento. 42 cm - 16.54"
- C.** Arm height. Hauteur des bras. Altura de brazo. 58 cm - 22.83"
- D.** Backrest height. Hauteur du dossier. Altura de respaldo. 90 cm - 35.43"
- E.** Seat depth. Profondeur d'assise. Profundidad de asiento. 56 cm - 22.05"
- F.** Depth. Profondeur. Profundidad. 95 cm - 37.40"

### FINISHES. TRAITS. ACABADOS.

---

Finishes for the metal bases. Finitions des pieds métalliques. Acabados de las patas metálicas.

---

Polyester powder paint. Peinture polyester en poudre. Pintura poliéster en polvo.

---



Manganese metal.  
Métal manganèse.  
Metal manganeso.

## PARK.

### PRICES. PRIX. PRECIOS.

#### PARK. Sofa. Canapé. Sofá.

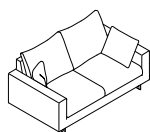

**PARS170**

170 x 95 H90  
66.93" x 37.40" H35.43"

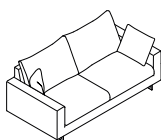

**PARS195**

195 x 95 H90  
76.77" x 37.40" H35.43"

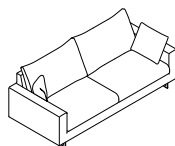

**PARS220**

220 x 95 H90  
86.61" x 37.40" H35.43"

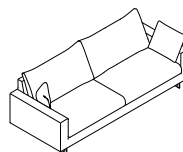

**PARS240**

240 x 95 H90  
94.49" x 37.40" H35.43"

| MEASUREMENT. MESURE. MEDIDA.           | REF.    | M.L. | COM / COL | 1        | 2        | 3        | 4        | 5        | L1       | L2       |
|--|---------|------|-----------|----------|----------|----------|----------|----------|----------|----------|
| 170 x 95 H90   66.92" x 37.40" H35.43" | PARS170 | 9    | 1.595,04  | 1.706,61 | 1.801,65 | 1.933,88 | 2.181,82 | 2.665,29 | 2.756,20 | 3.173,55 |
| 195 x 95 H90   76.77" x 37.40" H35.43" | PARS195 | 9.5  | 1.735,54  | 1.822,31 | 1.962,81 | 2.086,78 | 2.351,24 | 2.880,17 | 2.975,21 | 3.450,41 |
| 220 x 95 H90   86.61" x 37.40" H35.43" | PARS220 | 10   | 1.756,20  | 1.876,03 | 2.012,40 | 2.144,63 | 2.396,69 | 2.954,55 | 3.061,98 | 3.541,32 |
| 240 x 95 H90   94.48" x 37.40" H35.43" | PARS240 | 10.5 | 1.962,81  | 2.066,12 | 2.181,82 | 2.351,24 | 2.644,63 | 3.239,67 | 3.334,71 | 3.863,64 |

#### PARK. Sofa with 1 arm. Canapé avec 1 accoudoir. Sofá con 1 brazo.

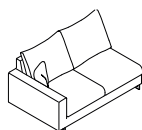

**PARS1155**

155 x 95 H90  
61.02" x 37.40" H35.43"  
IZQ.

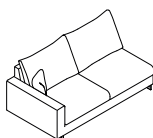

**PARS1180**

180 x 95 H90  
70.87" x 37.40" H35.43"  
IZQ.

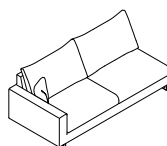

**PARS1205**

205 x 95 H90  
80.71" x 37.40" H35.43"  
IZQ.

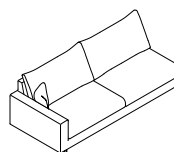

**PARS1225**

225 x 95 H90  
88.58" x 37.40" H35.43"  
IZQ.



**PARSD155**

155 x 95 H90  
61.02" x 37.40" H35.43"  
DER.

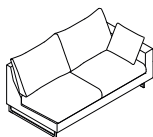

**PARSD180**

180 x 95 H90  
70.87" x 37.40" H35.43"  
DER.

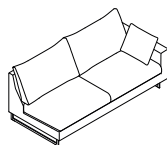

**PARSD205**

205 x 95 H90  
80.71" x 37.40" H35.43"  
DER.

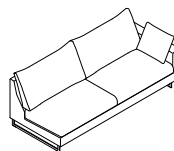

**PARSD225**

225 x 95 H90  
88.58" x 37.40" H35.43"  
DER.

| MEASUREMENT. MESURE. MEDIDA.           | REF.                | M.L. | COM / COL | 1        | 2        | 3        | 4        | 5        | L1       | L2       |
|--|---------------------|------|-----------|----------|----------|----------|----------|----------|----------|----------|
| 155 x 95 H90   61.02" x 37.40" H35.43" | PARS1155 - PARSD155 | 8    | 1.433,88  | 1.516,53 | 1.652,89 | 1.756,20 | 1.962,81 | 2.380,17 | 2.454,55 | 2.851,24 |
| 180 x 95 H90   70.86" x 37.40" H35.43" | PARS1180 - PARSD180 | 8.5  | 1.566,12  | 1.669,42 | 1.772,73 | 1.917,36 | 2.144,63 | 2.607,44 | 2.710,74 | 3.128,10 |
| 205 x 95 H90   80.70" x 37.40" H35.43" | PARS1205 - PARSD205 | 9.5  | 1.706,61  | 1.801,65 | 1.917,36 | 2.028,93 | 2.293,39 | 2.814,05 | 2.917,36 | 3.371,90 |
| 225 x 95 H90   88.58" x 37.40" H35.43" | PARS1225 - PARSD225 | 10   | 1.822,31  | 1.933,88 | 2.066,12 | 2.181,82 | 2.462,81 | 3.004,13 | 3.107,44 | 3.570,25 |

**PARK.**

**PRICES. PRIX. PRECIOS.**

PARK. Corner. Angle. Rincón.

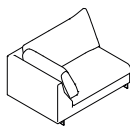

**PARRI135**

135 x 95 H90  
53.15" x 37.40" H35.43"  
IZQ.

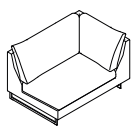

**PARRD135**

135 x 95 H90  
53.15" x 37.40" H35.43"  
DER.

| MEASUREMENT. MESURE. MEDIDA.           | REF.                | M.L. | COM / COL | 1        | 2        | 3        | 4        | 5        | L1       | L2       |
|--|---------------------|------|-----------|----------|----------|----------|----------|----------|----------|----------|
| 135 x 95 H90   53.14" x 37.40" H35.43" | PARRI135 - PARRD135 | 7.5  | 1.384,30  | 1.462,81 | 1.557,85 | 1.652,89 | 1.830,58 | 2.198,35 | 2.293,39 | 2.607,44 |

PARK. Chaise longue.

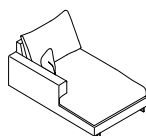

**PARCLI98**

98 x 155 H90  
38.58" x 61.02" H35.43"  
IZQ.

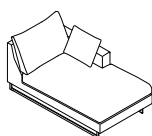

**PARCLD98**

98 x 155 H90  
38.58" x 61.02" H35.43"  
DER.

| MEASUREMENT. MESURE. MEDIDA.           | REF.                | M.L. | COM / COL | 1        | 2        | 3        | 4        | 5        | L1       | L2       |
|--|---------------------|------|-----------|----------|----------|----------|----------|----------|----------|----------|
| 98 x 155 H90   38.58" x 61.02" H35.43" | PARCLI98 - PARCLD98 | 7    | 1.433,88  | 1.516,53 | 1.611,57 | 1.727,27 | 1.917,36 | 2.293,39 | 2.380,17 | 2.710,74 |

PARK. Open corner. Angle ouvert. Rincón abierto.

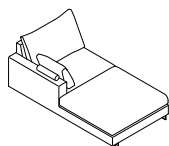

**PARRAI105**

105 x 195 H90  
41.34" x 76.77" H35.43"  
IZQ.

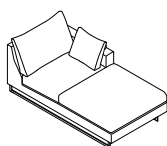

**PARRAD105**

105 x 195 H90  
41.34" x 76.77" H35.43"  
DER.

| MEASUREMENT. MESURE. MEDIDA.            | REF.                  | M.L. | COM / COL | 1        | 2        | 3        | 4        | 5        | L1       | L2       |
|---|-----------------------|------|-----------|----------|----------|----------|----------|----------|----------|----------|
| 105 x 195 H90   41.33" x 76.77" H35.43" | PARRAI105 - PARRAD105 | 9    | 1.801,65  | 1.917,36 | 2.028,93 | 2.169,42 | 2.396,69 | 2.909,09 | 3.004,13 | 3.450,41 |

PARK.

PRICES. PRIX. PRECIOS.

---

PARK. Ottomans. Poufs. Ottomans.

---

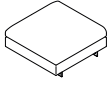

**PARP95**

95 x 95 H42  
37.40"x 37.40" H16.54"

| MEASUREMENT. MESURE. MEDIDA.         | REF.   | M.L. | COM / COL | 1      | 2      | 3      | 4      | 5        | L1       | L2       |
|--------------------------------------|--------|------|-----------|--------|--------|--------|--------|----------|----------|----------|
| 95 x 95 H42   37.40"x 37.40" H16.53" | PARP95 | 3    | 789,26    | 826,45 | 892,56 | 942,15 | 987,60 | 1.198,35 | 1.252,07 | 1.450,41 |





Designer  
Mario Ruiz

STYLE. ESTILO.  
Essential

VERSION. VERSIÓN.  
Standard depth. Profondeur standard. Profundidad estándar. (97 cm - 38.19 in)

## FEATURES. TRAITS. CARACTERÍSTICAS.

---

Removable upholstery in seat, back and auxiliary cushions.

Wooden frame covered with flexible cold shaped polyurethane foam and polyester fibre with backrest support.

Seat cushions in different polyurethane foam densities, with surface padding in fibre. Back cushions stuffed with polyester silicone fibre. Auxiliary cushions stuffed with polyester silicone fibre.

Metal bases coated in polyester powder paint with a manganese topcoat and LDPE stops.

Two back cushions heights available: Standard (78 cm - 30.71 in) or Premium (88 cm - 34.65 in)

Tapiserie déhoussable sur les coussins de l'assise, coussins du dossier et coussins auxiliaires.

Cadre en bois recouvert de mousse de polyuréthane souple à froid et de fibre de polyester avec support de dossier.

Coussins de l'assise réalisés dans différentes densités de mousse polyuréthane, matelassés en surface avec du fibre. Coussins du dossier garnis de fibre de polyester silicone. Coussins auxiliaires garnis de fibre de polyester silicone.

Pieds métalliques recouverts en peinture polyester en poudre finition manganèse avec butées en PEBD.

Deux hauteurs de coussin pour le dossiers disponibles: Standard (78 cm) ou Premium (88 cm)

Tapicería desenfundable en cojines de asiento, cojines de respaldo y cojines auxiliares.

Bastidor de madera recubierto de espuma de poliuretano flexible en frío y fibra de poliéster, con soporte de respaldo en metal.

Cojines de asiento realizados en distintas densidades de espuma poliuretano, acolchado en la superficie con fibra. Cojines de respaldo rellenos de fibra siliconada. Cojines auxiliares rellenos de fibra de poliéster siliconada.

Patas metálicas recubiertas en pintura poliéster en polvo acabado manganeso con topes de LDPE.

Dos alturas de respaldo disponibles: Standard (78 cm) o Premium (88 cm)



## PULSE.

### GENERAL MEASUREMENTS. MESURES GÉNÉRALES. MEDIDAS GENERALES.

---

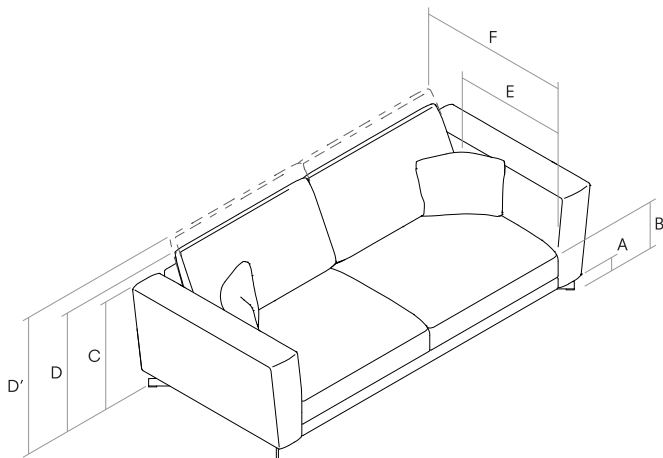

- A. Feet height. Hauteur du pied. Altura de la pata. 9 cm - 3.54"
- B. Seat height. Hauteur du siège. Altura de asiento. 42 cm - 16.54"
- C. Arm height. Hauteur du bras. Altura de brazo. 59 cm - 23.23"
- D. Backrest height. Hauteur du dossier. Altura de respaldo. 78 cm - 30.71"
- D'. Backrest height. Hauteur du dossier. Altura de respaldo. 88 cm - 34.55"
- E. Seat depth. Profondeur d'assise. Profundidad de sentada. 62 cm - 24.41"
- F. Depth. Profondeur. Profundidad. 97 cm - 38.19"

### FINISHES. TRAITS. ACABADOS.

---

Finishes for the metal bases. Finitions des pieds métalliques. Acabados de las patas metálicas.

---

Polyester powder paint. Peinture polyester en poudre. Pintura poliéster en polvo.

---



Manganese metal.  
Métal manganèse.  
Metal manganeso.

### OPTIONAL BACK CUSHIONS. COUSSINS DU DOSSIER EN OPTION. COJINES DE RESPALDO OPCIONALES.

---

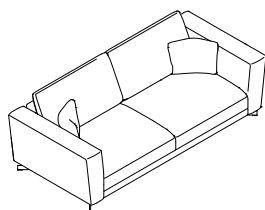

Standard option. Option standard. Opción estándar.  
Backrest height. Hauteur du dossier. Altura de respaldo.  
**78 cm - 30.71"**

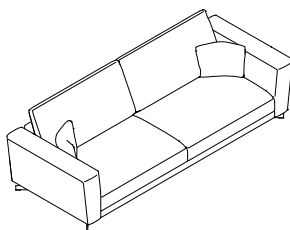

Premium option. Option premium. Opción premium.  
Backrest height. Hauteur du dossier. Altura de respaldo.  
**88 cm - 34.55"**

PULSE.

PRICES. PRIX. PRECIOS.

PULSE. Sofa. Canapé. Sofá.

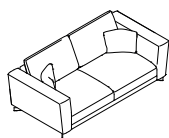

**PULS210RBPS**

210 x 97 H88  
82.68" x 38.19" H34.65"

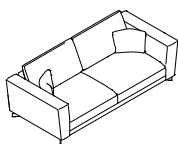

**PULS230RBPS**

230 x 97 H88  
90.55" x 38.19" H34.65"

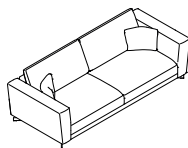

**PULS250RBPS**

250 x 97 H88  
98.43" x 38.19" H34.65"

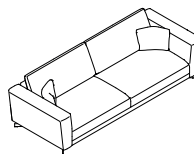

**PULS270RBPS**

270 x 97 H88  
106.30" x 38.19" H34.65"

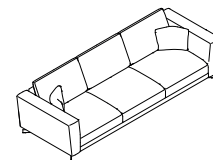

**PULS290RBPS**

290 x 97 H88  
114.17" x 38.19" H34.65"

| MEASUREMENT. MESURE. MEDIDA.           | REF.        | M.L. | COM / COL | 1        | 2        | 3        | 4        | 5        | L1       | L2       |
|--|-------------|------|-----------|----------|----------|----------|----------|----------|----------|----------|
| 210 x 97 H88   82.67" x 38.18" H34.64" | PULS210RBPS | 11.2 | 2.342,98  | 2.438,02 | 2.578,51 | 2.719,01 | 3.024,79 | 3.545,45 | 3.780,99 | 4.305,79 |
| 230 x 97 H88   90.55" x 38.18" H34.64" | PULS230RBPS | 11.5 | 2.553,72  | 2.648,76 | 2.789,26 | 2.929,75 | 3.243,80 | 3.780,99 | 4.016,53 | 4.570,25 |
| 250 x 97 H88   98.42" x 38.18" H34.64" | PULS250RBPS | 11.7 | 2.739,67  | 2.834,71 | 2.983,47 | 3.053,72 | 3.446,28 | 4.016,53 | 4.252,07 | 4.822,31 |
| 270 x 97 H88   106.2" x 38.18" H34.64" | PULS270RBPS | 12.2 | 3.045,45  | 3.140,50 | 3.305,79 | 3.483,47 | 3.797,52 | 4.392,56 | 4.533,06 | 5.128,10 |
| 290 x 97 H88   114.1" x 38.18" H34.64" | PULS290RBPS | 15.3 | 3.500,00  | 3.623,97 | 3.842,98 | 4.041,32 | 4.471,07 | 5.227,27 | 5.392,56 | 6.161,16 |

PULSE. Sofa with 1 arm. Canapé avec 1 accoudoir. Sofá con 1 brazo.

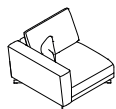

**PULSI105RBPS**

105 x 97 H88  
41.34" x 38.19" H34.65"  
IZQ.

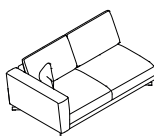

**PULSI185RBPS**

185 x 97 H88  
72.83" x 38.19" H34.65"  
IZQ.

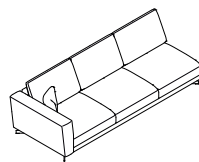

**PULSI265RBPS**

265 x 97 H88  
104.33" x 38.19" H34.65"  
IZQ.

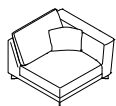

**PULSD105RBPS**

105 x 97 H88  
41.34" x 38.19" H34.65"  
DER.

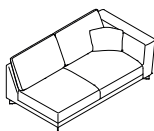

**PULSD185RBPS**

185 x 97 H88  
72.83" x 38.19" H34.65"  
DER.

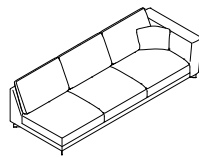

**PULSD265RBPS**

265 x 97 H88  
104.33" x 38.19" H34.65"  
DER.

| MEASUREMENT. MESURE. MEDIDA.           | REF.                        | M.L. | COM / COL | 1        | 2        | 3        | 4        | 5        | L1       | L2       |
|--|-----------------------------|------|-----------|----------|----------|----------|----------|----------|----------|----------|
| 105 x 97 H88   41.33" x 38.18" H34.64" | PULSI105RBPS - PULSD105RBPS | 6.5  | 1.466,94  | 1.512,40 | 1.599,17 | 1.669,42 | 1.842,98 | 2.115,70 | 2.239,67 | 2.537,19 |
| 185 x 97 H88   72.83" x 38.18" H34.64" | PULSI185RBPS - PULSD185RBPS | 10.1 | 2.177,69  | 2.256,20 | 2.388,43 | 2.528,93 | 2.780,99 | 3.264,46 | 3.446,28 | 3.929,75 |
| 265 x 97 H88   104.3" x 38.18" H34.64" | PULSI265RBPS - PULSD265RBPS | 14.2 | 3.053,72  | 3.177,69 | 3.367,77 | 3.561,98 | 3.954,55 | 4.657,02 | 4.814,05 | 5.516,53 |

## PULSE.

PRICES. PRIX. PRECIOS.

PULSE. Sofas without arms. Canapés sans accoudoirs. Sofás sin brazos.



**PULS080RBPS**

80 x 97 H88  
31.50" x 38.19" H34.65"

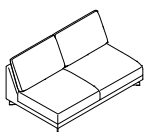

**PULS0160RBPS**

160 x 97 H88  
62.99" x 38.19" H34.65"

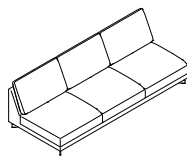

**PULS0240RBPS**

240 x 97 H88  
94.49" x 38.19" H34.65"

| MEASUREMENT. MESURE. MEDIDA.           | REF.         | M.L. | COM / COL | 1        | 2        | 3        | 4        | 5        | L1       | L2       |
|--|--------------|------|-----------|----------|----------|----------|----------|----------|----------|----------|
| 80 x 97 H88   31.49" x 38.18" H34.64"  | PULS080RBPS  | 5.3  | 1.206,61  | 1.239,67 | 1.301,65 | 1.371,90 | 1.491,74 | 1.710,74 | 1.818,18 | 2.037,19 |
| 160 x 97 H88   62.99" x 38.18" H34.64" | PULS0160RBPS | 9    | 1.904,96  | 1.975,21 | 2.090,91 | 2.202,48 | 2.438,02 | 2.834,71 | 3.024,79 | 3.429,75 |
| 240 x 97 H88   94.48" x 38.18" H34.64" | PULS0240RBPS | 13   | 2.694,21  | 2.797,52 | 2.975,21 | 3.148,76 | 3.491,74 | 4.111,57 | 4.367,77 | 5.016,53 |

PULSE. Corners. Angles. Rincones.

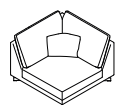

**PULR97RBPS**

97 x 97 H88  
38.19" x 38.19" H34.65"

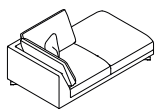

**PULRI177RBPS**

177 x 97 H88  
69.69" x 38.19" H34.65"  
IZQ.

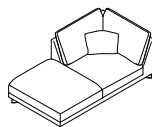

**PULRD177RBPS**

177 x 97 H88  
69.69" x 38.19" H34.65"  
DER.

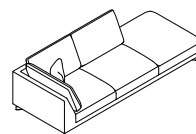

**PULRI257RBPS**

257 x 97 H88  
101.18" x 38.19" H34.65"  
IZQ.

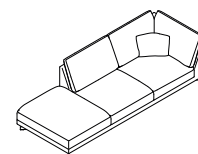

**PULRD257PS**

257 x 97 H88  
101.18" x 38.19" H34.65"  
DER.

| MEASUREMENT. MESURE. MEDIDA.           | REF.                        | M.L. | COM / COL | 1        | 2        | 3        | 4        | 5        | L1       | L2       |
|--|-----------------------------|------|-----------|----------|----------|----------|----------|----------|----------|----------|
| 97 x 97 H88   38.18" x 38.18" H34.64"  | PULR97RBPS                  | 7.5  | 1.607,44  | 1.669,42 | 1.764,46 | 1.859,50 | 2.053,72 | 2.388,43 | 2.537,19 | 2.896,69 |
| 177 x 97 H88   69.68" x 38.18" H34.64" | PULRI177RBPS - PULRD177RBPS | 11.7 | 2.483,47  | 2.578,51 | 2.727,27 | 2.888,43 | 3.194,21 | 3.743,80 | 3.971,07 | 4.557,85 |
| 257 x 97 H88   101.1" x 38.18" H34.64" | PULRI257RBPS - PULRD257RBPS | 15.5 | 3.367,77  | 3.500,00 | 3.710,74 | 3.921,49 | 4.351,24 | 5.128,10 | 5.297,52 | 6.074,38 |

PULSE. Sofa corners. Canapés angle. Sofás rincón.

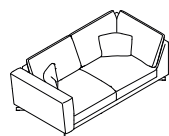

**PULSRI202RBPS**

202 x 97 H88  
79.53" x 38.19" H34.65"  
IZQ.

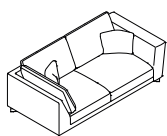

**PULSRD202RBPS**

202 x 97 H88  
79.53" x 38.19" H34.65"  
DER.

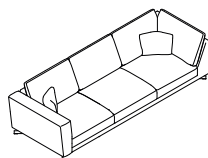

**PULSRI282RBPS**

282 x 97 H88  
111.02" x 38.19" H34.65"  
IZQ.

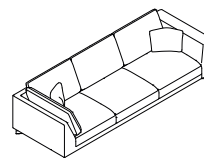

**PULSRD282RBPS**

282 x 97 H88  
111.02" x 38.19" H34.65"  
DER.

| MEASUREMENT. MESURE. MEDIDA.           | REF.                          | M.L. | COM / COL | 1        | 2        | 3        | 4        | 5        | L1       | L2       |
|--|-------------------------------|------|-----------|----------|----------|----------|----------|----------|----------|----------|
| 202 x 97 H88   79.52" x 38.18" H34.64" | PULSRI202RBPS - PULSRD202RBPS | 13   | 2.710,74  | 2.818,18 | 2.983,47 | 3.157,02 | 3.500,00 | 4.103,31 | 4.367,77 | 4.979,34 |
| 282 x 97 H88   111.0" x 38.18" H34.64" | PULSRI282RBPS - PULSRD282RBPS | 17   | 3.615,70  | 3.764,46 | 4.008,26 | 4.252,07 | 4.743,80 | 5.619,83 | 5.805,79 | 6.698,35 |

PULSE.

PRICES. PRIX. PRECIOS.

PULSE. Open corners. Angles ouverts. Rincones abiertos.

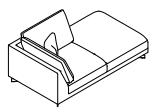

**PULRAI177RBPS**  
177 x 97 H88  
69.69" x 38.19" H34.65"  
IZQ.

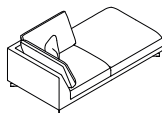

**PULRAI194RBPS**  
194 x 97 H88  
76.38" x 38.19" H34.65"  
IZQ.

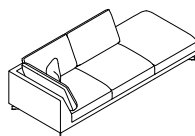

**PULRAI257RBPS**  
257 x 97 H88  
101.18" x 38.19" H34.65"  
IZQ.

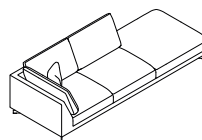

**PULRAI274RBPS**  
274 x 97 H88  
107.87" x 38.19" H34.65"  
IZQ.

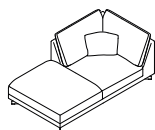

**PULRAD177RBPS**  
177 x 97 H88  
69.69" x 38.19" H34.65"  
DER.

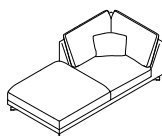

**PULRAD194RBPS**  
194 x 97 H88  
76.38" x 38.19" H34.65"  
DER.

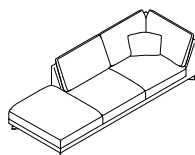

**PULRAD257RBPS**  
257 x 97 H88  
101.18" x 38.19" H34.65"  
DER.

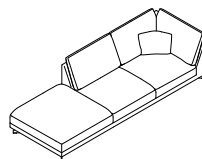

**PULRAD274RBPS**  
274 x 97 H88  
107.87" x 38.19" H34.65"  
DER.

| MEASUREMENT. MESURE. MEDIDA.           | REF.                          | M.L. | COM / COL | 1        | 2        | 3        | 4        | 5        | L1       | L2       |
|--|-------------------------------|------|-----------|----------|----------|----------|----------|----------|----------|----------|
| 177 x 97 H88   69.68" x 38.18" H34.64" | PULRAI177RBPS - PULRAD177RBPS | 10   | 2.247,93  | 2.326,45 | 2.458,68 | 2.586,78 | 2.851,24 | 3.326,45 | 3.524,79 | 4.008,26 |
| 194 x 97 H88   76.37" x 38.18" H34.64" | PULRAI194RBPS - PULRAD194RBPS | 10   | 2.380,17  | 2.458,68 | 2.599,17 | 2.719,01 | 2.983,47 | 3.446,28 | 3.657,02 | 4.140,50 |
| 257 x 97 H88   101.1" x 38.18" H34.64" | PULRAI257RBPS - PULRAD257RBPS | 14   | 3.202,48  | 3.305,79 | 3.516,53 | 3.710,74 | 4.095,04 | 4.797,52 | 4.946,28 | 5.644,63 |
| 274 x 97 H88   107.8" x 38.18" H34.64" | PULRAI274RBPS - PULRAD274RBPS | 14   | 3.404,96  | 3.524,79 | 3.727,27 | 3.913,22 | 4.305,79 | 4.987,60 | 5.157,02 | 5.847,11 |

PULSE. Island with or without arms. Île avec ou sans accoudoirs. Isla con o sin brazos.

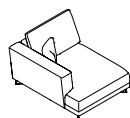

**PULI105RBPS**  
105 x 123 H88  
41.34" x 48.43" H34.65"  
IZQ.

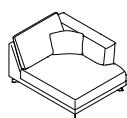

**PULID105RBPS**  
105 x 123 H88  
41.34" x 48.43" H34.65"  
DER.

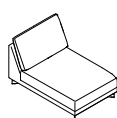

**PULI80RBPS**  
80 x 123 H88  
31.50" x 48.43" H34.65"

| MEASUREMENT. MESURE. MEDIDA.            | REF.                       | M.L. | COM / COL | 1        | 2        | 3        | 4        | 5        | L1       | L2       |
|---|----------------------------|------|-----------|----------|----------|----------|----------|----------|----------|----------|
| 105 x 123 H88   41.33" x 48.42" H34.64" | PULI105RBPS - PULID105RBPS | 7.5  | 1.809,92  | 1.859,50 | 1.946,28 | 2.037,19 | 2.210,74 | 2.520,66 | 2.673,55 | 2.995,87 |
| 80 x 123 H88   31.49" x 48.42" H34.64"  | PULI80RBPS                 | 7    | 1.557,85  | 1.586,78 | 1.652,89 | 1.735,54 | 1.859,50 | 2.115,70 | 2.247,93 | 2.504,13 |

**PULSE.**

**PRICES. PRIX. PRECIOS.**

**PULSE. Chaise longue.**

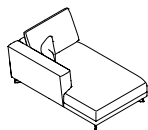

**PULCLI105RBPS**

105 x 160 H88  
41.34" x 62.99" H34.65"  
IZQ.

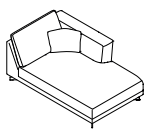

**PULCLD105RBPS**

105 x 160 H88  
41.34" x 62.99" H34.65"  
DER.

| MEASUREMENT. MESURE. MEDIDA.            | REF.                          | M.L. | COM / COL | 1        | 2        | 3        | 4        | 5        | L1       | L2       |
|---|-------------------------------|------|-----------|----------|----------|----------|----------|----------|----------|----------|
| 105 x 160 H88   41.33" x 62.99" H34.64" | PULCLI105RBPS - PULCLD105RBPS | 9    | 2.095,04  | 2.161,16 | 2.285,12 | 2.388,43 | 2.623,97 | 3.041,32 | 3.210,74 | 3.636,36 |

**PULSE. Ottomans. Poufs. Ottomans.**

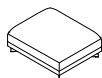

**PULP80PS**

80 x 97 H40  
31.50" x 38.19" H15.75"

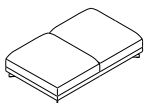

**PULP160PS**

160 x 97 H40  
62.99" x 38.19" H15.75"



**PULP80P80**

80 x 80 H40  
31.50" x 31.50" H15.75"

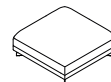

**PULP97PS**

97 x 97 H40  
38.19" x 38.19" H15.75"

| MEASUREMENT. MESURE. MEDIDA.           | REF.      | M.L. | COM / COL | 1        | 2        | 3        | 4        | 5        | L1       | L2       |
|--|-----------|------|-----------|----------|----------|----------|----------|----------|----------|----------|
| 80 x 97 H40   31.49" x 38.18" H15.74"  | PULP80PS  | 3    | 958,68    | 979,34   | 1.016,53 | 1.053,72 | 1.132,23 | 1.252,07 | 1.318,18 | 1.450,41 |
| 160 x 97 H40   62.99" x 38.18" H15.74" | PULP160PS | 5    | 1.508,26  | 1.545,45 | 1.623,97 | 1.677,69 | 1.809,92 | 2.028,93 | 2.144,63 | 2.380,17 |
| 80 x 80 H40   31.49" x 31.49" H15.74"  | PULP80P80 | 2.5  | 904,96    | 933,88   | 971,07   | 1.000,00 | 1.053,72 | 1.169,42 | 1.198,35 | 1.309,92 |
| 97 x 97 H40   38.18" x 38.18" H15.74"  | PULP97PS  | 3.5  | 1.066,12  | 1.090,91 | 1.132,23 | 1.177,69 | 1.252,07 | 1.404,96 | 1.479,34 | 1.632,23 |

## PULSE.

### FINISHES. TRAITS. ACABADOS.

---

#### Furniture. Meubles. Muebles.

---

#### Wood finishes. Finitions bois. Acabado de la madera.

---



**RN**  
Natural oak.  
Chêne naturel.  
Roble natural.



**NA**  
Natural american walnut.  
Noyer américain.  
Nogal americano.



**RT**  
Dark stained oak.  
Chêne teint foncée.  
Roble teñido oscuro.



**RL**  
Oak painted in black with open-pore finish.  
Chêne laqué noir à pores ouverts.  
Roble lacado negro por abierto.

#### Lacquered. Laqué. Lacados.

---



SEDA



ALOE



KHAKI



BRICK



RUBI



KOKOA

#### Pad. Leather finish for the top. Finition en cuir de la partie supérieure. Acabados para la parte superior.

---

#### Leather. Cuir. Piel.

---



NUVOLA  
199



NUVOLA  
163



ELMOBALTIQUE  
88042



NUVOLA  
155



NUVOLA  
151



NUVOLA  
147



ELMOBALTIQUE  
33280



ELMOBALTIQUE  
43003



ELMOBALTIQUE  
99011

#### Pad. Finish for the underside. Finition de la face inférieure. Acabado para la parte inferior.

---

#### Matt lacquer. Laque mate. Lacado mate.

---



KOKOA

**PULSE.**

**PRICES. PRIX. PRECIOS.**

PULSE. Furniture. Meubles. Muebles.



**PULMU94PS**

94 x 40 H45  
37.01" x 15.75" H17.72"



**PULMU94CPS**

94 x 40 H45  
37.01" x 15.75" H17.72"

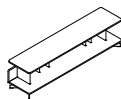

**PULMU174PS**

174 x 40 H45  
68.50" x 15.75" H17.72"

| MEASUREMENT. MESURE. MEDIDA.          | FINISHES. TRAITS. ACABADOS.   | REF.         | PRICE. PRIX. PRECIO. |
|---------------------------------------|---|--------------|----------------------|
| 94 x 40 H45   37.01" x 15.75" H17.72" | Natural oak. Chêne naturel. Roble natural.  | PULMU94PSRN  | 1.161,16             |
| 94 x 40 H45   37.01" x 15.75" H17.72" | American walnut. Noyer américain. Nogal americano.  | PULMU94PSNA  | 1.252,07             |
| 94 x 40 H45   37.01" x 15.75" H17.72" | Dark stained oak. Chêne teinté foncé. Roble teñido oscuro.  | PULMU94PSRT  | 1.161,16             |
| 94 x 40 H45   37.01" x 15.75" H17.72" | Oak painted in black with open-pore finish. Chêne laqué noir à pores ouverts. Roble lacado negro por abierto. | PULMU94PSRL  | 1.252,07             |
| 94 x 40 H45   37.01" x 15.75" H17.72" | Matt lacquer. Laque mate. Lacado mate.  | PULMU94PSLA  | 1.161,16             |
| 94 x 40 H45   37.01" x 15.75" H17.72" | Natural oak. Chêne naturel. Roble natural.  | PULMU94CPSRN | 1.161,16             |
| 94 x 40 H45   37.01" x 15.75" H17.72" | American walnut. Noyer américain. Nogal americano.  | PULMU94CPSNA | 1.252,07             |
| 94 x 40 H45   37.01" x 15.75" H17.72" | Dark stained oak. Chêne teinté foncé. Roble teñido oscuro.  | PULMU94CPSRT | 1.161,16             |
| 94 x 40 H45   37.01" x 15.75" H17.72" | Oak painted in black with open-pore finish. Chêne laqué noir à pores ouverts. Roble lacado negro por abierto. | PULMU94CPSRL | 1.252,07             |
| 94 x 40 H45   37.01" x 15.75" H17.72" | Matt lacquer. Laque mate. Lacado mate.  | PULMU94CPSLA | 1.161,16             |
| 174 x 40 H45   68.5" x 15.75" H17.72" | Natural oak. Chêne naturel. Roble natural.  | PULMU174PSRN | 1.504,13             |
| 174 x 40 H45   68.5" x 15.75" H17.72" | American walnut. Noyer américain. Nogal americano.  | PULMU174PSNA | 1.590,91             |
| 174 x 40 H45   68.5" x 15.75" H17.72" | Dark stained oak. Chêne teinté foncé. Roble teñido oscuro.  | PULMU174PSRT | 1.504,13             |
| 174 x 40 H45   68.5" x 15.75" H17.72" | Oak painted in black with open-pore finish. Chêne laqué noir à pores ouverts. Roble lacado negro por abierto. | PULMU174PSRL | 1.590,91             |
| 174 x 40 H45   68.5" x 15.75" H17.72" | Matt lacquer. Laque mate. Lacado mate.  | PULMU174PSLA | 1.504,13             |

PULSE. Pad.



**PULPA86L2**

86 x 37 H2  
33.86" x 14.57" H0.79"

| MEASUREMENT. MESURE. MEDIDA.        | FINISHES. TRAITS. ACABADOS. | REF.      | PRICE. PRIX. PRECIO. |
|-------------------------------------|-----------------------------|-----------|----------------------|
| 86 x 37 H2   33.86" x 14.57" H0.79" | Leather. Cuir. Piel.        | PULPA86L2 | 454,55               |

# PULSE.

# SOFA. CANAPÉ. SOFÁ.



Designer  
Mario Ruiz

STYLE. ESTILO.  
Essential

VERSION. VERSIÓN.  
Deluxe depth. Profondeur deluxe. Profundidad deluxe. (117 cm - 46.06 in)

## FEATURES. TRAITS. CARACTERÍSTICAS.

---

Removable upholstery in seat, back and auxiliary cushions.

Wooden frame covered with flexible cold shaped polyurethane foam and polyester fibre.

Seat cushions in different polyurethane foam densities, with surface padding in fibre. Primary back cushions stuffed with polyester silicone fibre. Secondary back cushions in different polyurethane foam densities, with surface padding in fibre. Auxiliary cushions stuffed with polyester silicone fibre.

Metal bases coated in polyester powder paint with a manganese topcoat and LDPE stops.

One back cushion height available: Premium (88 cm - 34.65 in)

Tapiserie déhoussable sur les coussins de l'assise, coussins du dossier et coussins auxiliaires.

Cadre en bois recouvert de mousse de polyuréthane souple à froid et de fibre de polyester.

Coussins de l'assise réalisés dans différentes densités de mousse polyuréthane, matelés en surface avec du fibre. Coussins du dossier primaires garnis de fibre de polyester silicone. Coussins du dossier secondaires garnis de fibre de polyester et plumes lavées et stérilisées. Coussins auxiliaires garnis de fibre de polyester silicone.

Pieds métalliques recouverts en peinture polyester en poudre finition manganèse avec butées en PEBD.

Une hauteur de coussin pour le dossier disponible : Premium (88 cm)

Tapicería desenfundable en cojines de asiento, cojines de respaldo y cojines auxiliares.

Bastidor de madera recubierto de espuma de poliuretano flexible en frío y fibra de poliéster.

Cojines de asiento realizados en distintas densidades de espuma poliuretano, acolchados en la superficie con fibra. Cojines de respaldo principales rellenos de fibra de poliéster siliconada y pluma lavada y esterilizada. Cojines de respaldo secundarios realizados en distintas densidades de espuma poliuretano, acolchados en la superficie con fibra. Cojines auxiliares rellenos de fibra siliconada.

Patas metálicas recubiertas en pintura poliéster en polvo acabado manganeso con topes de LDPE.

Una altura de respaldo disponible: Premium (88 cm)



## PULSE.

### GENERAL MEASUREMENTS. MESURES GÉNÉRALES. MEDIDAS GENERALES.

---

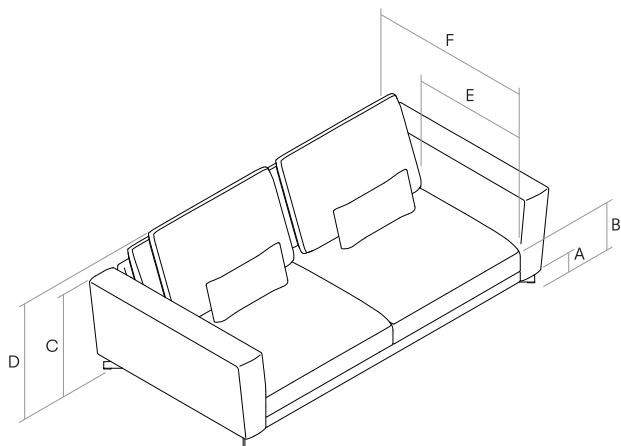

- A. Feet height. Hauteur du pied. Altura de la pata. 9 cm - 3.54"
- B. Seat height. Hauteur du siège. Altura de asiento. 42 cm - 16.54"
- C. Arm height. Hauteur du bras. Altura de brazo. 59 cm - 23.23"
- D. Backrest height. Hauteur du dossier. Altura de respaldo. 88 cm - 34.55"
- E. Seat depth. Profondeur d'assise. Profundidad de sentada. 66 cm - 25.98"
- F. Depth. Profondeur. Profundidad. 117 cm - 46.06"

### FINISHES. TRAITS. ACABADOS.

---

Finishes for the metal bases. Finitions des pieds métalliques. Acabados de las patas metálicas.

---

Polyester powder paint. Peinture polyester en poudre. Pintura poliéster en polvo.

---



Manganese metal.  
Métal manganèse.  
Metal manganeso.

PULSE.

PRICES. PRIX. PRECIOS.

SEAT CUSHION 80 CM. COUSSIN DE L'ASSISE DE 80 CM. COJÍN DE ASIENTO DE 80 CM.

PULSE. Sofa. Canapé. Sofá.

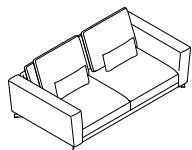

**PULS230PD**

230 x 117 H88  
90.55"x 46.06" H34.65"

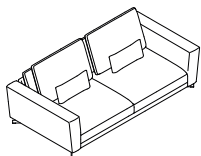

**PULS250PD**

250 x 117 H88  
98.43"x 46.06" H34.65"

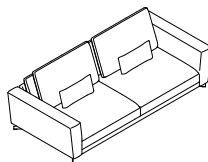

**PULS270PD**

270 x 117 H88  
106.30"x 46.06" H34.65"

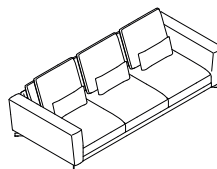

**PULS290PD**

290 x 117 H88  
114.17"x 46.06" H34.65"

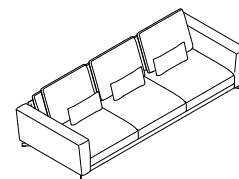

**PULS320PD**

320 x 117 H88  
125.98"x 46.06" H34.65"

| MEASUREMENT. MESURE. MEDIDA.            | REF.      | M.L. | COM / COL | 1        | 2        | 3        | 4        | 5        | L1       | L2       |
|---|-----------|------|-----------|----------|----------|----------|----------|----------|----------|----------|
| 230 x 117 H88   90.55"x 46.06" H34.65"  | PULS230PD | 13.5 | 3.157,02  | 3.247,93 | 3.450,41 | 3.619,83 | 3.995,87 | 4.669,42 | 4.809,92 | 5.483,47 |
| 250 x 117 H88   98.43"x 46.06" H34.65"  | PULS250PD | 14.5 | 3.400,83  | 3.524,79 | 3.723,14 | 3.913,22 | 4.318,18 | 5.037,19 | 5.190,08 | 5.909,09 |
| 270 x 117 H88   106.30"x 46.06" H34.65" | PULS270PD | 15.5 | 3.818,18  | 3.950,41 | 4.177,69 | 4.404,96 | 4.847,11 | 5.644,63 | 5.822,31 | 6.619,83 |
| 290 x 117 H88   114.17"x 46.06" H34.65" | PULS290PD | 18.5 | 4.223,14  | 4.384,30 | 4.661,16 | 4.925,62 | 5.462,81 | 6.429,75 | 6.644,63 | 7.611,57 |
| 320 x 117 H88   125.98"x 46.06" H34.65" | PULS320PD | 20   | 4.574,38  | 4.743,80 | 5.037,19 | 5.322,31 | 5.900,83 | 6.950,41 | 7.165,29 | 8.219,01 |

PULSE. Sofa with 1 arm. Canapé avec 1 accoudoir. Sofá con 1 brazo.

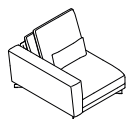

**PULSI105PD**

105 x 117 H88  
41.34"x 46.06" H34.65"  
IZQ.

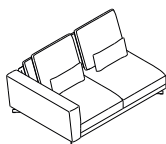

**PULSI185PD**

185 x 117 H88  
72.83"x 46.06" H34.65"  
IZQ.

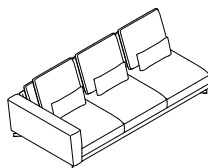

**PULSI265PD**

265 x 117 H88  
104.33"x 46.06" H34.65"  
IZQ.

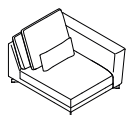

**PULSD105PD**

105 x 117 H88  
41.34"x 46.06" H34.65"  
DER.

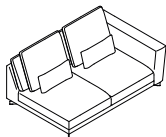

**PULSD185PD**

185 x 117 H88  
72.83"x 46.06" H34.65"  
DER.

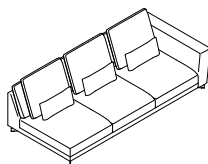

**PULSD265PD**

265 x 117 H88  
104.33"x 46.06" H34.65"  
DER.

| MEASUREMENT. MESURE. MEDIDA.            | REF.                    | M.L. | COM / COL | 1        | 2        | 3        | 4        | 5        | L1       | L2       |
|---|-------------------------|------|-----------|----------|----------|----------|----------|----------|----------|----------|
| 105 x 117 H88   41.34"x 46.06" H34.65"  | PULSI105PD - PULSD105PD | 7    | 1.764,46  | 1.822,31 | 1.917,36 | 2.012,40 | 2.210,74 | 2.557,85 | 2.636,36 | 2.983,47 |
| 185 x 117 H88   72.83"x 46.06" H34.65"  | PULSI185PD - PULSD185PD | 12   | 2.739,67  | 2.834,71 | 3.004,13 | 3.181,82 | 3.516,53 | 4.128,10 | 4.260,33 | 4.876,03 |
| 265 x 117 H88   104.33"x 46.06" H34.65" | PULSI265PD - PULSD265PD | 17   | 3.913,22  | 4.061,98 | 4.318,18 | 4.574,38 | 5.066,12 | 5.975,21 | 6.165,29 | 7.070,25 |

**PULSE.**

PRICES. PRIX. PRECIOS.

SEAT CUSHION 80 CM. COUSSIN DE L'ASSISE DE 80 CM. COJÍN DE ASIENTO DE 80 CM.

PULSE. Sofas without arms. Canapés sans accoudoirs. Sofás sin brazos.

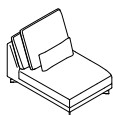

**PULS080PD**  
80 x 117 H88  
31.50"x 46.06" H34.65"

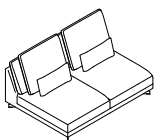

**PULS0160PD**  
160 x 117 H88  
62.99"x 46.06" H34.65"

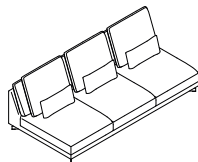

**PULS0240PD**  
240 x 117 H88  
94.49"x 46.06" H34.65"

| MEASUREMENT. MESURE. MEDIDA.           | REF.       | M.L. | COM / COL | 1        | 2        | 3        | 4        | 5        | L1       | L2       |
|--|------------|------|-----------|----------|----------|----------|----------|----------|----------|----------|
| 80 x 117 H88   31.50"x 46.06" H34.65"  | PULS080PD  | 6    | 1.545,45  | 1.595,04 | 1.669,42 | 1.743,80 | 1.904,96 | 2.190,08 | 2.247,93 | 2.528,93 |
| 160 x 117 H88   62.99"x 46.06" H34.65" | PULS0160PD | 11   | 2.446,28  | 2.528,93 | 2.690,08 | 2.834,71 | 3.136,36 | 3.677,69 | 3.809,92 | 4.355,37 |
| 240 x 117 H88   94.49"x 46.06" H34.65" | PULS0240PD | 16   | 3.495,87  | 3.628,10 | 3.855,37 | 4.082,64 | 4.537,19 | 5.351,24 | 5.528,93 | 6.342,98 |

PULSE. Corners. Angles. Rincones.

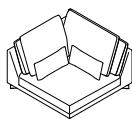

**PULR117PD**  
117 x 117 H88  
46.06"x 46.06" H34.65"

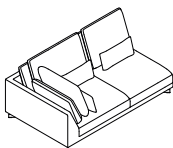

**PULRI197PD**  
197 x 117 H88  
77.56"x 46.06" H34.65"  
IZQ.

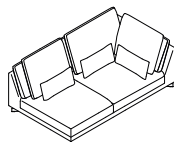

**PULRD197PD**  
197 x 117 H88  
77.56"x 46.06" H34.65"  
DER.

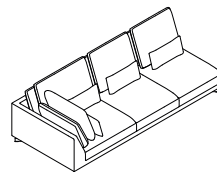

**PULRI277PD**  
277 x 117 H88  
109.06"x 46.06" H34.65"  
IZQ.

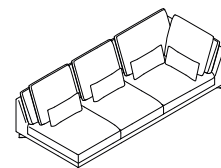

**PULRD277PD**  
277 x 117 H88  
109.06"x 46.06" H34.65"  
DER.

| MEASUREMENT. MESURE. MEDIDA.            | REF.                    | M.L. | COM / COL | 1        | 2        | 3        | 4        | 5        | L1       | L2       |
|---|-------------------------|------|-----------|----------|----------|----------|----------|----------|----------|----------|
| 241 x 117 H88   94.49"x 46.06" H34.65"  | PULR117PD               | 9.5  | 2.264,46  | 2.351,24 | 2.483,47 | 2.615,70 | 2.863,64 | 3.326,45 | 3.450,41 | 3.900,83 |
| 197 x 117 H88   77.56"x 46.06" H34.65"  | PULRI197PD - PULRD197PD | 14.7 | 3.289,26  | 3.400,83 | 3.607,44 | 3.818,18 | 4.214,88 | 4.954,55 | 5.123,97 | 5.851,24 |
| 277 x 117 H88   109.06"x 46.06" H34.65" | PULRI277PD - PULRD277PD | 19.5 | 4.595,04  | 4.756,20 | 5.049,59 | 5.330,58 | 5.909,09 | 6.938,02 | 7.177,69 | 8.206,61 |

PULSE. Sofa corners. Canapés angle. Sofás rincón.

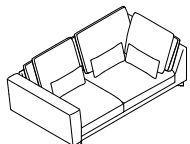

**PULSRI222PD**  
222 x 117 H88  
87.40"x 46.06" H34.65"  
IZQ.

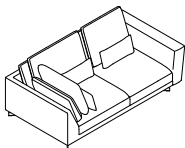

**PULSRD222PD**  
222 x 117 H88  
87.40"x 46.06" H34.65"  
DER.

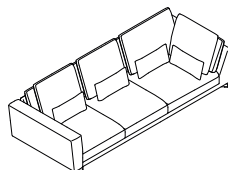

**PULSRI302PD**  
302 x 117 H88  
118.90"x 46.06" H34.65"  
IZQ.

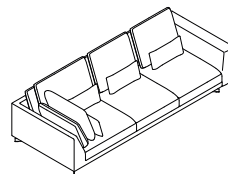

**PULSRD302PD**  
302 x 117 H88  
118.90"x 46.06" H34.65"  
DER.

| MEASUREMENT. MESURE. MEDIDA.            | REF.                      | M.L. | COM / COL | 1        | 2        | 3        | 4        | 5        | L1       | L2       |
|---|---------------------------|------|-----------|----------|----------|----------|----------|----------|----------|----------|
| 222 x 117 H88   87.40"x 46.06" H34.65"  | PULSRI222PD - PULSRD222PD | 16   | 3.466,94  | 3.590,91 | 3.818,18 | 4.037,19 | 4.479,34 | 5.272,73 | 5.454,55 | 6.260,33 |
| 302 x 117 H88   118.90"x 46.06" H34.65" | PULSRI302PD - PULSRD302PD | 21   | 4.772,73  | 4.954,55 | 5.264,46 | 5.566,12 | 6.173,55 | 7.280,99 | 7.524,79 | 8.632,23 |

PULSE.

PRICES. PRIX. PRECIOS.

SEAT CUSHION 80 CM. COUSSIN DE L'ASSISE DE 80 CM. COJÍN DE ASIENTO DE 80 CM.

PULSE. Open corners. Angles ouverts. Rincones abiertos.

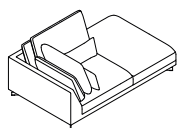

**PULRAI197PD**

197 x 117 H88  
77.56"x 46.06" H34.65"  
IZQ.

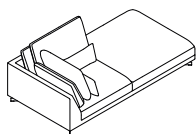

**PULRAI234PD**

234 x 117 H88  
92.13"x 46.06" H34.65"  
IZQ.

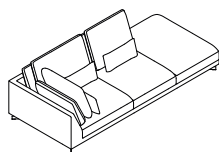

**PULRAI277PD**

277 x 117 H88  
109.06"x 46.06" H34.65"  
IZQ.

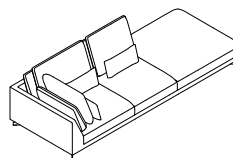

**PULRAI314PD**

314 x 117 H88  
123.62"x 46.06" H34.65"  
IZQ.

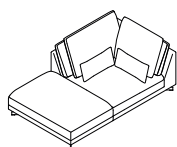

**PULRAD197PD**

197 x 117 H88  
77.56"x 46.06" H34.65"  
DER.

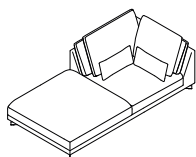

**PULRAD234PD**

234 x 117 H88  
92.13"x 46.06" H34.65"  
DER.

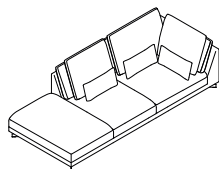

**PULRAD277PD**

277 x 117 H88  
109.06"x 46.06" H34.65"  
DER.

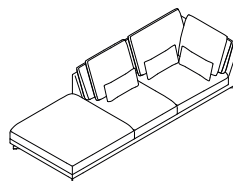

**PULRAD314PD**

314 x 117 H88  
123.62"x 46.06" H34.65"  
DER.

| MEASUREMENT. MESURE. MEDIDA.             | REF.                      | M.L. | COM / COL | 1        | 2        | 3        | 4        | 5        | L1       | L2       |
|--|---------------------------|------|-----------|----------|----------|----------|----------|----------|----------|----------|
| 197 x 117 H88   77.56" x 46.06" H34.65"  | PULRAI197PD - PULRAD197PD | 12.5 | 3.049,59  | 3.165,29 | 3.326,45 | 3.495,87 | 3.834,71 | 4.442,15 | 4.582,64 | 5.190,08 |
| 234 x 117 H88   92.13" x 46.06" H34.65"  | PULRAI234PD - PULRAD234PD | 12.5 | 3.458,68  | 3.553,72 | 3.723,14 | 3.892,56 | 4.223,14 | 4.847,11 | 4.971,07 | 5.595,04 |
| 277 x 117 H88   109.06" x 46.06" H34.65" | PULRAI277PD - PULRAD277PD | 17.5 | 4.235,54  | 4.384,30 | 4.632,23 | 4.876,03 | 5.359,50 | 6.239,67 | 6.429,75 | 7.309,92 |
| 314 x 117 H88   123.62" x 46.06" H34.65" | PULRAI314PD - PULRAD314PD | 17.5 | 4.698,35  | 4.859,50 | 5.095,04 | 5.351,24 | 5.851,24 | 6.752,07 | 6.950,41 | 7.859,50 |

PULSE. Island with or without arms. Île avec ou sans accoudoirs. Isla con o sin brazos.

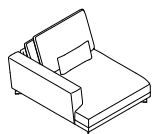

**PULI125P143**

125 x 143 H88  
49.21"x 56.30" H34.65"  
IZQ.

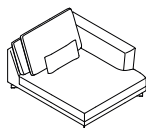

**PULID125P143**

125 x 143 H88  
49.21"x 56.30" H34.65"  
DER.

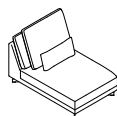

**PULI80P3**

80 x 143 H88  
31.50"x 56.30" H34.65"

| MEASUREMENT. MESURE. MEDIDA.            | REF.                       | M.L. | COM / COL | 1        | 2        | 3        | 4        | 5        | L1       | L2       |
|---|----------------------------|------|-----------|----------|----------|----------|----------|----------|----------|----------|
| 125 x 143 H88   49.21" x 56.30" H34.65" | PULI125P143 - PULID125P143 | 8    | 2.305,79  | 2.380,17 | 2.504,13 | 2.623,97 | 2.880,16 | 3.318,18 | 3.409,09 | 3.855,37 |
| 80 x 143 H88   31.50" x 56.30" H34.65"  | PULI80P143                 | 7    | 1.904,96  | 1.962,81 | 2.037,19 | 2.132,23 | 2.330,58 | 2.644,63 | 2.710,74 | 3.041,32 |

**PULSE.**

PRICES. PRIX. PRECIOS.

SEAT CUSHION 80 CM. COUSSIN DE L'ASSISE DE 80 CM. COJÍN DE ASIENTO DE 80 CM.

PULSE. Chaise longue.

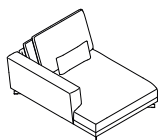

**PULCLI125PD**

125 x 160 H88  
49.21" x 62.99" H34.65"  
IZQ.

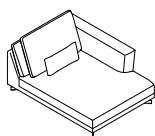

**PULCLD125PD**

125 x 160 H88  
49.21" x 62.99" H34.65"  
DER.

| MEASUREMENT. MESURE. MEDIDA.            | REF.                      | M.L. | COM / COL | 1        | 2        | 3        | 4        | 5        | L1       | L2       |
|---|---------------------------|------|-----------|----------|----------|----------|----------|----------|----------|----------|
| 125 x 160 H88   49.21" x 62.99" H34.65" | PULCLI125PD - PULCLD125PD | 10   | 2.491,74  | 2.570,25 | 2.702,48 | 2.834,71 | 3.090,91 | 3.458,68 | 3.665,29 | 4.140,50 |

PULSE. Ottomans. Poufs. Ottomans.

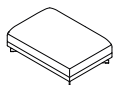

**PULP80PD**

80 x 117 H40  
31.50" x 46.06" H15.75"

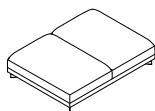

**PULP160PD**

160 x 117 H40  
62.99" x 46.06" H15.75"



**PULP80P80**

80 x 80 H40  
31.50" x 31.50" H15.75"

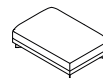

**PULP80P100**

80 x 100 H40  
31.50" x 39.37" H15.75"

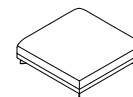

**PULP117PD**

117 x 117 H40  
46.06" x 46.06" H15.75"

| MEASUREMENT. MESURE. MEDIDA.            | REF.       | M.L. | COM / COL | 1        | 2        | 3        | 4        | 5        | L1       | L2       |
|---|------------|------|-----------|----------|----------|----------|----------|----------|----------|----------|
| 80 x 117 H40   31.50" x 46.06" H15.75"  | PULP80PD   | 3.5  | 1.148,76  | 1.198,35 | 1.227,27 | 1.264,46 | 1.347,11 | 1.500,00 | 1.528,93 | 1.677,69 |
| 160 x 117 H40   62.99" x 46.06" H15.75" | PULP160PD  | 5.5  | 1.809,92  | 1.859,50 | 1.925,62 | 1.995,87 | 2.152,89 | 2.417,36 | 2.462,81 | 2.731,40 |
| 80 x 80 H40   31.49" x 31.49" H15.74"   | PULP80P80  | 2.5  | 904,96    | 933,88   | 971,07   | 1.000,00 | 1.053,72 | 1.169,42 | 1.198,35 | 1.309,92 |
| 80 x 100 H40   31.50" x 46.06" H15.74"  | PULP80P100 | 3    | 1.053,72  | 1.074,38 | 1.111,57 | 1.148,76 | 1.227,27 | 1.359,50 | 1.384,30 | 1.528,93 |
| 117 x 117 H40   46.06" x 46.06" H15.74" | PULP117PD  | 4    | 1.330,58  | 1.359,50 | 1.404,96 | 1.462,81 | 1.566,12 | 1.735,54 | 1.793,39 | 1.962,81 |

PULSE.

PRICES. PRIX. PRECIOS.

SEAT CUSHION 100 CM. COUSSIN DE L'ASSISE DE 100 CM. COJÍN DE ASIENTO DE 100 CM.

PULSE. Open corners. Angles ouverts. Rincones abiertos.

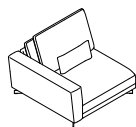

**PULSI125PD**

125 x 117 H88  
49.21" x 46.06" H34.65"  
IZQ.

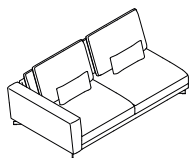

**PULSI225PD**

225 x 117 H88  
88.58" x 46.06" H34.65"  
IZQ.

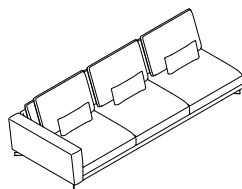

**PULSI325PD**

325 x 117 H88  
127.95" x 46.06" H34.65"  
IZQ.

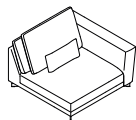

**PULSD125PD**

125 x 117 H88  
49.21" x 46.06" H34.65"  
DER.

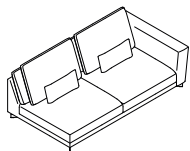

**PULSD225PD**

225 x 117 H88  
88.58" x 46.06" H34.65"  
DER.

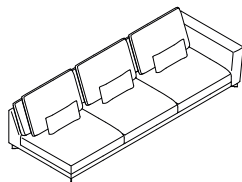

**PULSD325PD**

325 x 117 H88  
127.95" x 46.06" H34.65"  
DER.

| MEASUREMENT. MESURE. MEDIDA.             | REF.                    | M.L. | COM / COL | 1        | 2        | 3        | 4        | 5        | L1       | L2       |
|--|-------------------------|------|-----------|----------|----------|----------|----------|----------|----------|----------|
| 125 x 117 H88   49.21" x 46.06" H34.65"  | PULSI125PD - PULSD125PD | 8    | 1.946,28  | 2.000,00 | 2.115,70 | 2.219,01 | 2.438,02 | 2.822,31 | 2.909,09 | 3.297,52 |
| 225 x 117 H88   88.58" x 46.06" H34.65"  | PULSI225PD - PULSD225PD | 13   | 3.107,44  | 3.223,14 | 3.400,83 | 3.582,64 | 3.950,41 | 4.603,31 | 4.743,80 | 5.409,09 |
| 325 x 117 H88   127.95" x 46.06" H34.65" | PULSI325PD - PULSD325PD | 18.5 | 4.516,53  | 4.677,69 | 4.954,55 | 5.227,27 | 5.768,60 | 6.731,40 | 6.950,41 | 7.933,88 |

PULSE. Sofas without arms. Canapés sans accoudoirs. Sofás sin brazo.

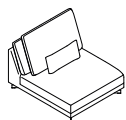

**PULS0100PD**

100 x 117 H88  
39.37" x 46.06" H34.65"

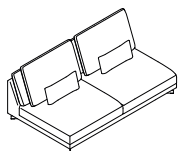

**PULS0200PD**

200 x 117 H88  
78.74" x 46.06" H34.65"

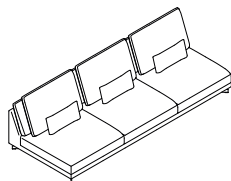

**PULS0300PD**

300 x 117 H88  
118.11" x 46.06" H34.65"

| MEASUREMENT. MESURE. MEDIDA.             | REF.       | M.L. | COM / COL | 1        | 2        | 3        | 4        | 5        | L1       | L2       |
|--|------------|------|-----------|----------|----------|----------|----------|----------|----------|----------|
| 100 x 117 H88   39.37" x 46.06" H34.65"  | PULS0100PD | 6.5  | 1.727,27  | 1.785,12 | 1.867,77 | 1.954,55 | 2.144,63 | 2.462,81 | 2.528,93 | 2.851,24 |
| 200 x 117 H88   78.74" x 46.06" H34.65"  | PULS0200PD | 11.5 | 2.834,71  | 2.938,02 | 3.107,44 | 3.268,60 | 3.599,17 | 4.185,95 | 4.318,18 | 4.913,22 |
| 300 x 117 H88   118.11" x 46.06" H34.65" | PULS0300PD | 18   | 4.260,33  | 4.421,49 | 4.677,69 | 4.942,15 | 5.462,81 | 6.400,83 | 6.619,83 | 7.553,72 |

**PULSE.**

PRICES. PRIX. PRECIOS.

SEAT CUSHION 100 CM. COUSSIN DE L'ASSISE DE 100 CM. COJÍN DE ASIENTO DE 100 CM.

PULSE. Corners. Angles. Rincones.

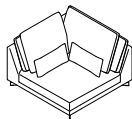

**PULR117PD**

117 x 117 H88  
46.06" x 46.06" H34.65"

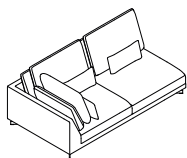

**PULRI217PD**

217 x 117 H88  
85.43" x 46.06" H34.65"  
IZQ.

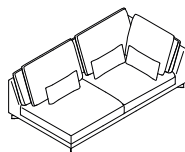

**PULRD217PD**

217 x 117 H88  
85.43" x 46.06" H34.65"  
DER.

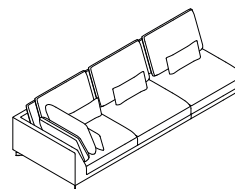

**PULRI317PD**

317 x 97 H88  
124.80" x 46.06" H34.65"  
IZQ.

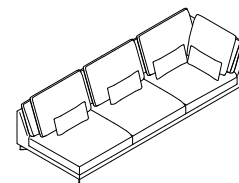

**PULRD317PD**

317 x 97 H88  
124.80" x 46.06" H34.65"  
DER.

| MEASUREMENT. MESURE. MEDIDA.             | REF.                    | M.L. | COM / COL | 1        | 2        | 3        | 4        | 5        | L1       | L2       |
|--|-------------------------|------|-----------|----------|----------|----------|----------|----------|----------|----------|
| 241 x 117 H88   94.49" x 46.06" H34.65"  | PULR117PD               | 9.5  | 2.264,46  | 2.351,24 | 2.483,47 | 2.615,70 | 2.863,64 | 3.326,45 | 3.450,41 | 3.900,83 |
| 217 x 117 H88   85.43" x 46.06" H34.65"  | PULRI217PD - PULRD217PD | 16   | 3.582,64  | 3.702,48 | 3.929,75 | 4.157,02 | 4.603,31 | 5.409,09 | 5.595,04 | 6.380,17 |
| 317 x 117 H88   124.80" x 46.06" H34.65" | PULRI317PD - PULRD317PD | 21   | 5.115,70  | 5.285,12 | 5.586,78 | 5.900,83 | 6.512,40 | 7.603,31 | 7.847,11 | 8.946,28 |

PULSE. Sofa corners. Canapés angles. Sofás rincón.

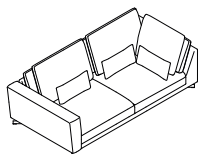

**PULSRI242PD**

242 x 117 H88  
95.28" x 46.06" H34.65"  
IZQ.

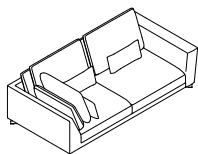

**PULSRD242PD**

242 x 117 H88  
95.28" x 46.06" H34.65"  
DER.

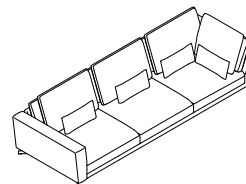

**PULSRI342PD**

342 x 117 H88  
134.65" x 46.06" H34.65"  
IZQ.

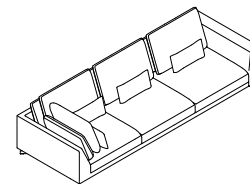

**PULSRD342PD**

342 x 117 H88  
134.65" x 46.06" H34.65"  
DER.

| MEASUREMENT. MESURE. MEDIDA.             | REF.                      | M.L. | COM / COL | 1        | 2        | 3        | 4        | 5        | L1       | L2       |
|--|---------------------------|------|-----------|----------|----------|----------|----------|----------|----------|----------|
| 242 x 117 H88   95.28" x 46.06" H34.65"  | PULSRI242PD - PULSRD242PD | 17   | 3.834,71  | 3.979,34 | 4.223,14 | 4.462,81 | 4.942,15 | 5.814,05 | 6.012,40 | 6.871,90 |
| 342 x 117 H88   134.65" x 46.06" H34.65" | PULSRI342PD - PULSRD342PD | 22   | 5.338,84  | 5.541,32 | 5.859,50 | 6.181,82 | 6.826,45 | 7.991,74 | 8.243,80 | 9.400,83 |

**PULSE.**

PRICES. PRIX. PRECIOS.

SEAT CUSHION 100 CM. COUSSIN DE L'ASSISE DE 100 CM. COJÍN DE ASIENTO DE 100 CM.

PULSE. Open corners. Angles ouverts. Rincones abiertos.

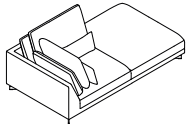

**PULRAI217PD**  
217 x 117 H88  
85.43"x 46.06" H34.65"  
IZQ.

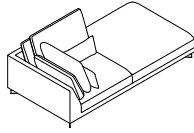

**PULRAI234PD**  
234 x 117 H88  
92.13"x 46.06" H34.65"  
IZQ.

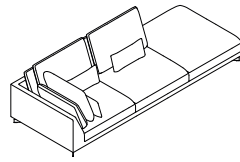

**PULRAI317PD**  
317 x 117 H88  
124.80"x 46.06" H34.65"  
IZQ.

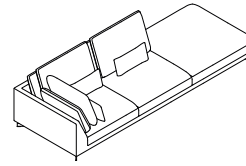

**PULRAI334PD**  
334 x 117 H88  
131.50"x 46.06" H34.65"  
IZQ.

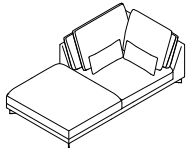

**PULRAD217PD**  
217 x 117 H88  
85.43"x 46.06" H34.65"  
DER.

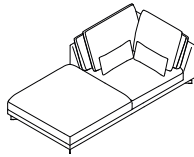

**PULRAD234PD**  
234 x 117 H88  
92.13"x 46.06" H34.65"  
DER.

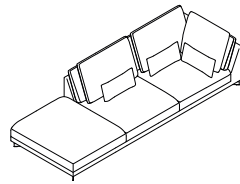

**PULRAD317PD**  
317 x 117 H88  
124.80"x 46.06" H34.65"  
DER.

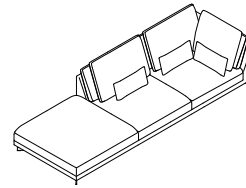

**PULRAD334PD**  
334 x 117 H88  
131.50"x 46.06" H34.65"  
DER.

| MEASUREMENT. MESURE. MEDIDA.            | REF.                      | M.L. | COM / COL | 1        | 2        | 3        | 4        | 5        | L1       | L2       |
|---|---------------------------|------|-----------|----------|----------|----------|----------|----------|----------|----------|
| 217 x 117 H88   85.43"x 46.06" H34.65"  | PULRAI217PD - PULRAD217PD | 12   | 3.202,48  | 3.297,52 | 3.475,21 | 3.636,36 | 3.979,34 | 4.595,04 | 4.727,27 | 5.330,58 |
| 234 x 117 H88   92.13"x 46.06" H34.65"  | PULRAI234PD - PULRAD234PD | 12.5 | 3.458,68  | 3.553,72 | 3.723,14 | 3.892,56 | 4.223,14 | 4.847,11 | 4.971,07 | 5.595,04 |
| 317 x 117 H88   124.80"x 46.06" H34.65" | PULRAI317PD - PULRAD317PD | 18.5 | 4.859,50  | 5.020,66 | 5.285,12 | 5.557,85 | 6.099,17 | 7.082,64 | 7.289,26 | 8.264,46 |
| 334 x 117 H88   131.50"x 46.06" H34.65" | PULRAI334PD - PULRAD334PD | 18.5 | 5.140,50  | 5.293,39 | 5.566,12 | 5.834,71 | 6.371,90 | 7.363,64 | 7.566,12 | 8.549,59 |

PULSE. Island with or without arms. Île avec ou sans accoudoirs. Isla con o sin brazos.

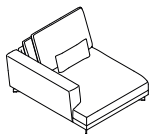

**PULI125P143**  
125 x 143 H88  
49.21"x 56.30" H34.65"  
IZQ.

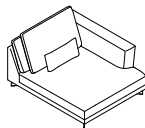

**PULID125P143**  
125 x 143 H88  
49.21"x 56.30" H34.65"  
DER.

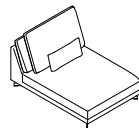

**PULI100P143**  
100 x 143 H88  
39.37"x 56.30" H34.65"

| MEASUREMENT. MESURE. MEDIDA.           | REF.                       | M.L. | COM / COL | 1        | 2        | 3        | 4        | 5        | L1       | L2       |
|--|----------------------------|------|-----------|----------|----------|----------|----------|----------|----------|----------|
| 125 x 143 H88   49.21"x 56.30" H34.65" | PULI125P143 - PULID125P143 | 8    | 2.305,79  | 2.380,17 | 2.504,13 | 2.623,97 | 2.880,16 | 3.318,18 | 3.409,09 | 3.855,37 |
| 100 x 143 H88   39.37"x 56.30" H34.65" | PULI100P143                | 8.5  | 2.086,78  | 2.161,16 | 2.256,20 | 2.359,50 | 2.586,78 | 2.954,55 | 3.033,06 | 3.409,09 |



**PULSE.**

PRICES. PRIX. PRECIOS.

SEAT CUSHION 100 CM. COUSSIN DE L'ASSISE DE 100 CM. COJÍN DE ASIENTO DE 100 CM.

PULSE. Chaise longue.

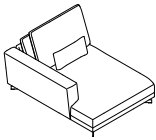

**PULCLI125PD**

125 x 160 H88  
49.21" x 62.99" H34.65"  
IZQ.

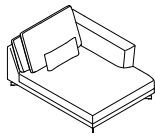

**PULCLD125PD**

125 x 160 H88  
49.21" x 62.99" H34.65"  
DER.

| MEASUREMENT. MESURE. MEDIDA.            | REF.                      | M.L. | COM / COL | 1        | 2        | 3        | 4        | 5        | L1       | L2       |
|---|---------------------------|------|-----------|----------|----------|----------|----------|----------|----------|----------|
| 125 x 160 H88   49.21" x 62.99" H34.65" | PULCLI125PD - PULCLD125PD | 10   | 2.491,74  | 2.570,25 | 2.702,48 | 2.834,71 | 3.090,91 | 3.458,68 | 3.665,29 | 4.140,50 |

PULSE. Ottomans. Poufs. Ottomans.

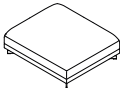

**PULP100PD**

100 x 117 H40  
39.37" x 46.06" H15.75"

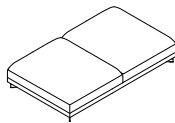

**PULP200PD**

200 x 117 H40  
78.74" x 46.06" H15.75"

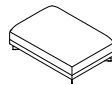

**PULP80P100**

80 x 100 H40  
31.50" x 39.37" H15.75"



**PULP100P100**

100 x 100 H40  
39.37" x 39.37" H15.75"

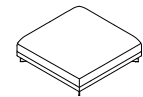

**PULP117PD**

117 x 117 H40  
46.06" x 46.06" H15.75"

| MEASUREMENT. MESURE. MEDIDA.            | REF.        | M.L. | COM / COL | 1        | 2        | 3        | 4        | 5        | L1       | L2       |
|---|-------------|------|-----------|----------|----------|----------|----------|----------|----------|----------|
| 100 x 117 H40   39.37" x 46.06" H15.75" | PULP100PD   | 4    | 1.235,54  | 1.264,46 | 1.309,92 | 1.359,50 | 1.442,15 | 1.611,57 | 1.652,89 | 1.830,58 |
| 200 x 117 H40   78.74" x 46.06" H15.75" | PULP200PD   | 6.5  | 2.078,51  | 2.078,51 | 2.152,89 | 2.235,54 | 2.409,09 | 2.702,48 | 2.768,60 | 3.070,25 |
| 80 x 100 H40   31.50" x 46.06" H15.74"  | PULP80P100  | 3    | 1.053,72  | 1.074,38 | 1.111,57 | 1.148,76 | 1.227,27 | 1.359,50 | 1.384,30 | 1.528,93 |
| 100 x 100 H40   39.37" x 39.37" H15.75" | PULP100P100 | 3.5  | 1.132,23  | 1.157,02 | 1.206,61 | 1.252,07 | 1.330,58 | 1.491,74 | 1.516,53 | 1.661,16 |
| 117 x 117 H40   46.06" x 46.06" H15.74" | PULP117PD   | 4    | 1.330,58  | 1.359,50 | 1.404,96 | 1.462,81 | 1.566,12 | 1.735,54 | 1.793,39 | 1.962,81 |

## PULSE.

### FINISHES. TRAITS. ACABADOS.

---

#### Furniture. Meubles. Muebles.

---

#### Wood finishes. Finitions bois. Acabado de la madera.

---



**RN**  
Natural oak.  
Chêne naturel.  
Roble natural.



**NA**  
Natural american walnut.  
Noyer américain.  
Nogal americano.



**RT**  
Dark stained oak.  
Chêne teint foncée.  
Roble teñido oscuro.



**RL**  
Oak painted in black with open-pore finish.  
Chêne laqué noir à pores ouverts.  
Roble lacado negro por abierto.



SEDA



ALOE



KHAKI



BRICK



RUBI



KOKOA

#### Pad. Leather finish for the top. Finition en cuir de la partie supérieure. Acabados para la parte superior.

---

#### Leather. Cuir. Piel.

---



NUVOLA  
199



NUVOLA  
163



ELMOBALTIQUE  
88042



NUVOLA  
155



NUVOLA  
151



NUVOLA  
147



ELMOBALTIQUE  
33280



ELMOBALTIQUE  
43003



ELMOBALTIQUE  
99011

#### Pad. Finish for the underside. Finition de la face inférieure. Acabado para la parte inferior.

---

#### Matt lacquer. Laque mate. Lacado mate.

---



KOKOA

**PULSE.**

**PRICES. PRIX. PRECIOS.**

PULSE. Furniture. Meubles. Muebles.



**PULMU114PD**

114 x 40 H45  
44,88" x 15.75" H17.72"



**PULMU114CPD**

114 x 40 H45  
44,88" x 15.75" H17.72"

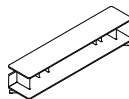

**PULMU194PD**

194 x 40 H45  
76,38" x 15.75" H17.72"

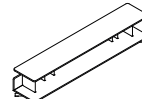

**PULMU214PD**

214 x 40 H45  
84,25" x 15.75" H17.72"

| MEASUREMENT. MESURE. MEDIDA.           | FINISHES. TRAITS. ACABADOS.   | REF.          | PRICE. PRIX. PRECIO. |
|--|---|---------------|----------------------|
| 114 x 40 H45   44.88" x 15.75" H17.72" | Natural oak. Chêne naturel. Roble natural.  | PULMU114PDRN  | 1.309,92             |
| 114 x 40 H45   44.88" x 15.75" H17.72" | American walnut. Noyer américain. Nogal americano.  | PULMU114PDNA  | 1.396,69             |
| 114 x 40 H45   44.88" x 15.75" H17.72" | Dark stained oak. Chêne teinté foncé. Roble teñido oscuro.  | PULMU114PDRT  | 1.309,92             |
| 114 x 40 H45   44.88" x 15.75" H17.72" | Oak painted in black with open-pore finish. Chêne laqué noir à pores ouverts. Roble lacado negro por abierto. | PULMU114PDRL  | 1.396,69             |
| 114 x 40 H45   44.88" x 15.75" H17.72" | Matt lacquer. Laque mate. Lacado mate.  | PULMU114PDLA  | 1.309,92             |
| 114 x 40 H45   44.88" x 15.75" H17.72" | Natural oak. Chêne naturel. Roble natural.  | PULMU114CPDRN | 1.309,92             |
| 114 x 40 H45   44.88" x 15.75" H17.72" | American walnut. Noyer américain. Nogal americano.  | PULMU114CPDNA | 1.396,69             |
| 114 x 40 H45   44.88" x 15.75" H17.72" | Dark stained oak. Chêne teinté foncé. Roble teñido oscuro.  | PULMU114CPDRT | 1.309,92             |
| 114 x 40 H45   44.88" x 15.75" H17.72" | Oak painted in black with open-pore finish. Chêne laqué noir à pores ouverts. Roble lacado negro por abierto. | PULMU114CPDRL | 1.396,69             |
| 114 x 40 H45   44.88" x 15.75" H17.72" | Matt lacquer. Laque mate. Lacado mate.  | PULMU114CPDLA | 1.309,92             |
| 194 x 40 H45   76.38" x 15.75" H17.72" | Natural oak. Chêne naturel. Roble natural.  | PULMU194PDRN  | 1.599,17             |
| 194 x 40 H45   76.38" x 15.75" H17.72" | American walnut. Noyer américain. Nogal americano.  | PULMU194PDNA  | 1.685,95             |
| 194 x 40 H45   76.38" x 15.75" H17.72" | Dark stained oak. Chêne teinté foncé. Roble teñido oscuro.  | PULMU194PDRT  | 1.599,17             |
| 194 x 40 H45   76.38" x 15.75" H17.72" | Oak painted in black with open-pore finish. Chêne laqué noir à pores ouverts. Roble lacado negro por abierto. | PULMU194PDRL  | 1.685,95             |
| 194 x 40 H45   76.38" x 15.75" H17.72" | Matt lacquer. Laque mate. Lacado mate.  | PULMU194PDLA  | 1.599,17             |
| 214 x 40 H45   84.25" x 15.75" H17.72" | Natural oak. Chêne naturel. Roble natural.  | PULMU214PDRN  | 1.685,95             |
| 214 x 40 H45   84.25" x 15.75" H17.72" | American walnut. Noyer américain. Nogal americano.  | PULMU214PDNA  | 1.785,12             |
| 214 x 40 H45   84.25" x 15.75" H17.72" | Dark stained oak. Chêne teinté foncé. Roble teñido oscuro.  | PULMU214PDRT  | 1.685,95             |
| 214 x 40 H45   84.25" x 15.75" H17.72" | Oak painted in black with open-pore finish. Chêne laqué noir à pores ouverts. Roble lacado negro por abierto. | PULMU214PDRL  | 1.785,12             |
| 214 x 40 H45   84.25" x 15.75" H17.72" | Matt lacquer. Laque mate. Lacado mate.  | PULMU214PDLA  | 1.685,12             |

PULSE. Pad.



**PULPA86L2**

86 x 37 H2  
33.86" x 14.57" H0.79"

| MEASUREMENT. MESURE. MEDIDA.        | FINISHES. TRAITS. ACABADOS. | REF.      | PRICE. PRIX. PRECIO. |
|-------------------------------------|-----------------------------|-----------|----------------------|
| 86 x 37 H2   33.86" x 14.57" H0.79" | Leather. Cuir. Piel.        | PULPA86L2 | 454,55               |



Designer  
Mario Ruiz

STYLE. ESTILO.  
Singular

VERSION. VERSIÓN.  
Low arm version. Version d'accoudoir bas. Versión de brazo bajo. (56 cm - 22.05 in)

## FEATURES. TRAITS. CARACTERÍSTICAS.

Removable upholstery in seat, back and auxiliary cushions.

Wooden frame covered with flexible cold shaped polyurethane foam and polyester fibre.

Seat cushions in different polyurethane foam densities, with surface padding in fibre. Back cushions stuffed with polyester fibre and washed, sterilised down. Auxiliary cushions stuffed with polyester fibre and washed, sterilised down.

Metal bases coated in polyester powder paint with a manganese topcoat and LDPE stops.

Two back cushions heights available: Standard (83 cm - 32.68 in) or Premium (90 cm - 35.43 in)

### REMOVABLE COVER VERSION FEATURES.

Completely removable upholstery. In leather, seat, back and auxiliary cushions with removable covers.

Wooden frame covered with flexible cold shaped polyurethane foam and polyester fibre.

Seat cushions in different polyurethane foam densities, with surface padding in fibre. Back cushions stuffed with polyester fibre and washed, sterilised down. Auxiliary cushions stuffed with polyester fibre and washed, sterilised down.

Metal bases coated in polyester powder paint with a manganese topcoat and LDPE stops.

Two back cushions heights available: Standard (83 cm - 32.68 in) or Premium (90 cm - 35.43 in)

**Removable upholstery option +15%**

**Option déhoussable +15%**

**Opción desenfundable +15%**

Tapiserie déhoussable sur les coussins de l'assise, coussins du dossier et coussins auxiliaires.

Cadre en bois recouvert de mousse de polyuréthane souple à froid et de fibre de polyester.

Coussins de l'assise réalisés dans différentes densités de mousse polyuréthane, matelassés en surface avec du fibre. Coussins du dossier garnis de fibre de polyester et plumes lavées et stérilisées. Coussins auxiliaires garnis de fibre de polyester et plumes lavées et stérilisées.

Bases métalliques recouverts en peinture polyester en poudre finition manganèse avec butées en PEBD.

Deux hauteurs de coussin pour le dossiers disponibles: Standard (83 cm) ou Premium (90 cm)

### TRAITS VERSION DÉHOUSSABLE.

Tapiserie entièrement déhoussable. En cuir, coussins de l'assise, du dossier et auxiliaires déhoussables.

Cadre en bois recouvert de mousse de polyuréthane souple à froid et de fibre de polyester.

Coussins de l'assise réalisés dans différentes densités de mousse polyuréthane, matelassés en surface avec du fibre. Coussins du dossier garnis de fibre de polyester et plumes lavées et stérilisées. Coussins auxiliaires garnis de fibre de polyester et plumes lavées et stérilisées.

Bases métalliques recouverts en peinture polyester en poudre finition manganèse avec butées en PEBD.

Deux hauteurs de coussin pour le dossiers disponibles: Standard (83 cm) ou Premium (90 cm)

Tapicería desenfundable en cojines de asiento, cojines de respaldos y cojines auxiliares.

Bastidor de madera recubierto de espuma de poliuretano flexible en frío y fibra de poliéster.

Cojines de asiento realizados es distintas densidades de espuma de poliuretano, acolchado en la superficie con fibra. Cojines de respaldo rellenos de fibra de poliéster y pluma lavada y esterilizada. Cojines auxiliares rellenos de fibra de poliéster y pluma lavada y esterilizada.

Bases metálicas recubiertas en pintura poliéster en polvo acabado manganeso con topes de LDPE.

Dos alturas de respaldo disponibles: Standard (83 cm) o Premium (90 cm)

### CARACTERÍSTICAS VERSIÓN DESENFUNDABLE.

Tapicería totalmente desenfundable. En piel, en cojines de asiento, respaldos y auxiliares desenfundables.

Bastidor de madera recubierto de espuma de poliuretano flexible en frío y fibra de poliéster.

Cojines de asiento realizados es distintas densidades de espuma de poliuretano, acolchado en la superficie con fibra. Cojines de respaldo rellenos de fibra de poliéster y pluma lavada y esterilizada. Cojines auxiliares rellenos de fibra de poliéster y pluma lavada y esterilizada.

Bases metálicas recubiertas en pintura poliéster en polvo acabado manganeso con topes de LDPE.

Dos alturas de respaldo disponibles: Standard (83 cm) o Premium (90 cm)

## SENSO.

### GENERAL MEASUREMENTS. MESURES GÉNÉRALES. MEDIDAS GENERALES.

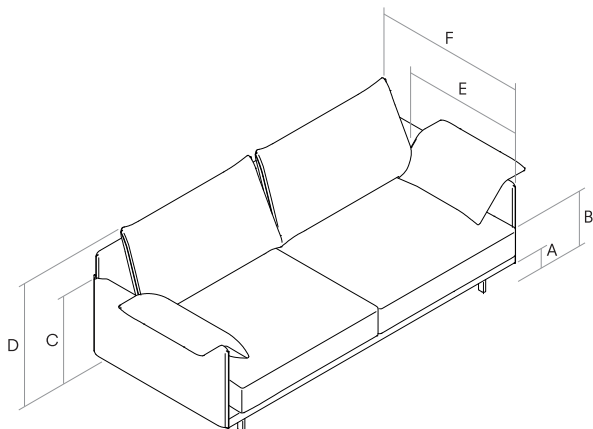

- A. Feet height. Hauteur du pied. Altura de la pata. 10 cm - 3.94"
- B. Seat height. Hauteur du siège. Altura de asiento. 42 cm - 16.54"
- C. Arm height. Hauteur du bras. Altura de brazo. 55 cm - 23.65"
- D. Backrest height. Hauteur du dossier. Altura de respaldo. 83 cm - 32.68"
- E. Seat depth. Profondeur d'assise. Profundidad de sentada. 60 cm - 23.62"
- F. Depth. Profondeur. Profundidad. 96 cm - 37.80"

### FINISHES. TRAITS. ACABADOS.

Finishes for the metal bases. Finitions des pieds métalliques. Acabados de las patas metálicas.

Polyester powder paint. Peinture polyester en poudre. Pintura poliéster en polvo.



Manganese metal.  
Métal manganèse.  
Metal manganeso.

### OPTIONAL BACK CUSHIONS. COUSSINS DU DOSSIER EN OPTION. COJINES DE RESPALDO OPCIONALES.

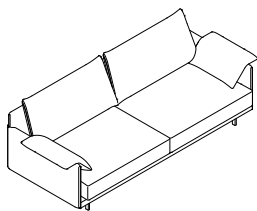

Standard option. Option standard. Opción estándar.  
Backrest height. Hauteur du dossier. Altura de respaldo.  
**83 cm - 32.68"**

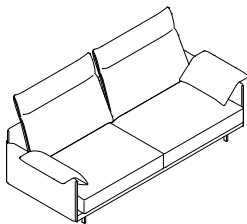

Premium option. Option premium. Opción premium.  
Backrest height. Hauteur du dossier. Altura de respaldo.  
**90 cm - 35.43"**



#### SENRA

Additional high backrest. Dossier haut supplémentaire. Respaldo alto adicional. Price per unit and for all measures. Prix par unité et pour toutes les mesures. Precio por unidad y para todas las medidas.



#### SENSR

High backrest supplement. Supplément dossier haut. Suplemento de respaldo alto. Price per unit and for all measures. Prix par unité et pour toutes les mesures. Precio por unidad y para todas las medidas.

| MEASUREMENT. MESURE. MEDIDA. | REF.  | COM / COL | 1      | 2      | 3      | 4      | 5      | L1     | L2     |
|------------------------------|-------|-----------|--------|--------|--------|--------|--------|--------|--------|
|                              | SENSR | 128,10    | 136,36 | 136,36 | 144,63 | 157,02 | 173,55 | 185,95 | 202,48 |
|                              | SENRA | 280,99    | 289,26 | 297,52 | 305,79 | 326,45 | 355,37 | 384,30 | 413,22 |

## SENSO.

PRICES. PRIX. PRECIOS.

SENSO. Sofa. Canapé. Sofá.

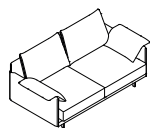

**SENS169BB**

169 x 96 H83  
66.54" x 37.80" H32.68"

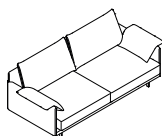

**SENS199BB**

199 x 96 H83  
78.35" x 37.80" H32.68"

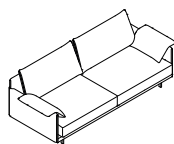

**SENS219BB**

219 x 96 H83  
86.22" x 37.80" H32.68"

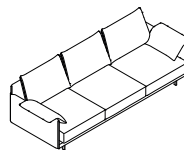

**SENS245BB**

245 x 96 H83  
96.46" x 37.80" H32.68"

| MEASUREMENT. MESURE. MEDIDA.           | REF.      | M.L. | COM / COL | 1        | 2        | 3        | 4        | 5        | L1       | L2       |
|--|-----------|------|-----------|----------|----------|----------|----------|----------|----------|----------|
| 169 x 96 H83   66.54" x 37.80" H32.68" | SENS169BB | 11   | 1.851,24  | 1.983,47 | 2.107,44 | 2.264,46 | 2.528,93 | 3.115,70 | 3.235,54 | 3.743,80 |
| 199 x 96 H83   78.35" x 37.80" H32.68" | SENS199BB | 11.5 | 2.000,00  | 2.107,44 | 2.272,73 | 2.429,75 | 2.780,99 | 3.413,22 | 3.533,06 | 4.140,50 |
| 219 x 96 H83   86.22" x 37.80" H32.68" | SENS219BB | 12.5 | 2.090,91  | 2.202,48 | 2.367,77 | 2.500,00 | 2.842,98 | 3.500,00 | 3.640,50 | 4.210,74 |
| 245 x 96 H83   96.46" x 37.80" H32.68" | SENS245BB | 14.5 | 2.458,68  | 2.607,44 | 2.826,45 | 3.037,19 | 3.413,22 | 4.202,48 | 4.367,77 | 5.095,04 |

SENSO. Sofas with 1 arm. Canapés avec 1 accoudoir. Sofás con 1 brazo.

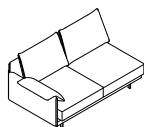

**SENSI161BB**

161 x 96 H83  
63.39" x 37.80" H32.68"  
IZQ.

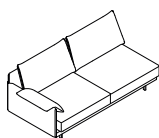

**SENSI191BB**

191 x 96 H83  
75.20" x 37.80" H32.68"  
IZQ.

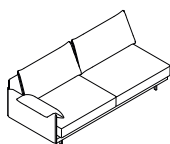

**SENSI211BB**

211 x 96 H83  
83.07" x 37.80" H32.68"  
IZQ.

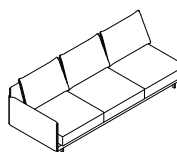

**SENSI237BB**

237 x 96 H83  
93.31" x 37.80" H32.68"  
IZQ.

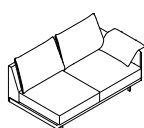

**SENSD161BB**

161 x 96 H83  
63.39" x 37.80" H32.68"  
DER.

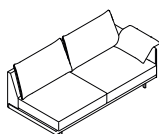

**SENSD191BB**

191 x 96 H83  
75.20" x 37.80" H32.68"  
DER.

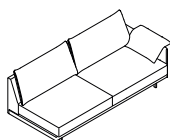

**SENSD211BB**

211 x 96 H83  
83.07" x 37.80" H32.68"  
DER.

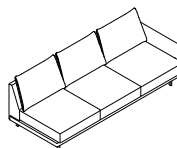

**SENSD237BB**

237 x 96 H83  
93.31" x 37.80" H32.68"  
DER.

| MEASUREMENT. MESURE. MEDIDA.           | REF.                    | M.L. | COM / COL | 1        | 2        | 3        | 4        | 5        | L1       | L2       |
|--|-------------------------|------|-----------|----------|----------|----------|----------|----------|----------|----------|
| 161 x 96 H83   63.39" x 37.80" H32.68" | SENSI161BB - SENSD161BB | 9.5  | 1.661,16  | 1.772,73 | 1.896,69 | 2.028,93 | 2.289,26 | 2.805,79 | 2.929,75 | 3.367,77 |
| 191 x 96 H83   75.20" x 37.80" H32.68" | SENSI191BB - SENSD191BB | 10.5 | 1.851,24  | 1.983,47 | 2.140,50 | 2.272,73 | 2.586,78 | 3.185,95 | 3.297,52 | 3.851,24 |
| 211 x 96 H83   83.07" x 37.80" H32.68" | SENSI211BB - SENSD211BB | 11.5 | 1.958,68  | 2.061,98 | 2.202,48 | 2.359,50 | 2.685,95 | 3.272,73 | 3.413,22 | 3.954,55 |
| 237 x 96 H83   93.31" x 37.80" H32.68" | SENSI237BB - SENSD237BB | 13.5 | 2.272,73  | 2.429,75 | 2.607,44 | 2.826,45 | 3.194,21 | 3.929,75 | 4.095,04 | 4.768,60 |

## SENSO.

### PRICES. PRIX. PRECIOS.

SENSO. Sofas without arms. Canapés sans accoudoirs. Sofás sin brazos.

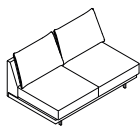

#### SENS0152

152 x 96 H83  
59.84" x 37.80" H32.68"

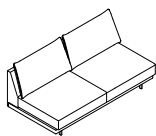

#### SENS0182

182 x 96 H83  
71.65" x 37.80" H32.68"

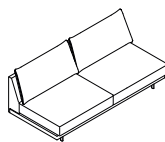

#### SENS0202

202 x 96 H83  
79.53" x 37.80" H32.68"

| MEASUREMENT. MESURE. MEDIDA.           | REF.     | M.L. | COM / COL | 1        | 2        | 3        | 4        | 5        | L1       | L2       |
|--|----------|------|-----------|----------|----------|----------|----------|----------|----------|----------|
| 152 x 96 H83   59.84" x 37.80" H32.68" | SENS0152 | 8    | 1.504,13  | 1.615,70 | 1.731,40 | 1.826,45 | 2.061,98 | 2.528,93 | 2.607,44 | 3.037,19 |
| 182 x 96 H83   71.65" x 37.80" H32.68" | SENS0182 | 8.5  | 1.677,69  | 1.793,39 | 1.896,69 | 2.028,93 | 2.247,93 | 2.702,48 | 2.805,79 | 3.202,48 |
| 202 x 96 H83   79.53" x 37.80" H32.68" | SENS0202 | 10   | 1.772,73  | 1.871,90 | 1.983,47 | 2.107,44 | 2.318,18 | 2.805,79 | 2.904,96 | 3.314,05 |

SENSO. Corners. Angles. Rincones.

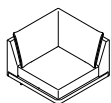

#### SENR96

96 x 96 H83  
37.80" x 37.80" H32.68"

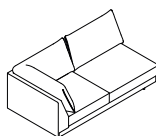

#### SENR187

187 x 96 H83

IZQ.

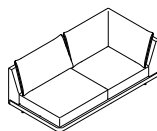

#### SENRD187

187 x 96 H83  
73.62" x 37.80" H32.68"

DER.

| MEASUREMENT. MESURE. MEDIDA.           | REF.               | M.L. | COM / COL | 1        | 2        | 3        | 4        | 5        | L1       | L2       |
|--|--------------------|------|-----------|----------|----------|----------|----------|----------|----------|----------|
| 96 x 96 H83   37.80" x 37.80" H32.68"  | SENR96             | 6.5  | 1.371,90  | 1.458,68 | 1.537,19 | 1.632,23 | 1.818,18 | 2.185,95 | 2.264,46 | 2.586,78 |
| 187 x 96 H83   73.62" x 37.80" H32.68" | SENR187 - SENRD187 | 10   | 1.958,68  | 2.082,64 | 2.202,48 | 2.359,50 | 2.669,42 | 3.272,73 | 3.404,96 | 3.929,75 |

SENSO. Chaise longue.

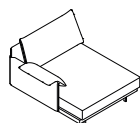

#### SENCLI105BB

105 x 155 H83  
41.34" x 61.02" H32.68"  
IZQ.

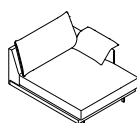

#### SENCLD105BB

105 x 155 H83  
41.34" x 61.02" H32.68"  
DER.

| MEASUREMENT. MESURE. MEDIDA.            | REF.                      | M.L. | COM / COL | 1        | 2        | 3        | 4        | 5        | L1       | L2       |
|---|---------------------------|------|-----------|----------|----------|----------|----------|----------|----------|----------|
| 105 x 155 H83   41.34" x 61.02" H32.68" | SENCLI105BB - SENCLD105BB | 8.5  | 1.623,97  | 1.731,40 | 1.834,71 | 1.966,94 | 2.202,48 | 2.685,95 | 2.797,52 | 3.235,54 |

SENSO.

FINISHES. TRAITS. ACABADOS.

---

Ottomans. Leather finish for the tray. Poufs. Finition en cuir du plateau. Ottoman. Acabados en piel para la bandeja.

---

Leather. Cuir. Piel.

---



NUVOLA  
199



NUVOLA  
163



ELMOBALTIQUE  
88042



NUVOLA  
155



NUVOLA  
151



NUVOLA  
147



ELMOBALTIQUE  
33280



ELMOBALTIQUE  
43003



ELMOBALTIQUE  
99011



SENSO.

PRICES. PRIX. PRECIOS.

SENSO. Ottomans. Poufs. Ottomans.

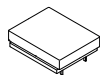

**SENP76**

76 x 96 H42  
29.92" x 37.80" H16.54"

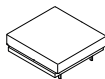

**SENP91**

91 x 96 H42  
35.83" x 37.80" H16.54"

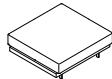

**SENP101**

101 x 96 H42  
39.76" x 37.80" H16.54"

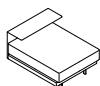

**SENP76BJ**

76 x 96 H55  
29.92" x 37.80" H21.65"

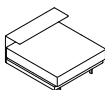

**SENP91BJ**

91 x 96 H55  
35.83" x 37.80" H21.65"

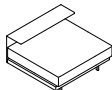

**SENP101BJ**

101 x 96 H55  
39.76" x 37.80" H21.65"

| MEASUREMENT. MESURE. MEDIDA.           | REF.      | M.L.        | COM / COL | 1        | 2        | 3        | 4        | 5        | L1       | L2       |
|--|-----------|-------------|-----------|----------|----------|----------|----------|----------|----------|----------|
| 76 x 96 H42   29.92" x 37.80" H16.54"  | SENP76    | 3           | 698,35    | 723,14   | 776,86   | 793,39   | 888,43   | 1.020,66 | 1.053,72 | 1.185,95 |
| 91 x 96 H42   35.83" x 37.80" H16.54"  | SENP91    | 3.5         | 747,93    | 776,86   | 818,18   | 888,43   | 933,88   | 1.107,44 | 1.144,63 | 1.264,46 |
| 101 x 96 H42   39.76" x 37.80" H16.54" | SENP101   | 3.5         | 785,12    | 818,18   | 834,71   | 904,96   | 983,47   | 1.144,63 | 1.161,16 | 1.318,18 |
| 76 x 96 H55   29.92" x 37.80" H21.65"  | SENP76BJ  | 3,00 + 1,00 | 904,96    | 950,41   | 995,87   | 1.053,72 | 1.152,89 | 1.363,64 | 1.404,96 | 1.607,44 |
| 91 x 96 H55   35.83" x 37.80" H21.65"  | SENP91BJ  | 3,50 + 1,50 | 950,41    | 1.004,13 | 1.053,72 | 1.123,97 | 1.231,40 | 1.458,68 | 1.475,21 | 1.677,69 |
| 101 x 96 H55   39.76" x 37.80" H21.65" | SENP101BJ | 3,50 + 1,50 | 1.004,13  | 1.053,72 | 1.123,97 | 1.177,69 | 1.301,65 | 1.553,72 | 1.590,91 | 1.826,45 |



Designer  
Mario Ruiz

STYLE. ESTILO.  
Singular

VERSION. VERSIÓN.

High arm version. Version à bras haut. Versión de brazo alto. (66 cm - 26 in)

## FEATURES. TRAITS. CARACTERÍSTICAS.

Removable upholstery in seat, back and auxiliary cushions.

Wooden frame covered with flexible cold shaped polyurethane foam and polyester fibre.

Seat cushions in different polyurethane foam densities, with surface padding in fibre. Back cushions stuffed with polyester fibre and washed, sterilised down.

Metal bases coated in polyester powder paint with a manganese topcoat and LDPE stops.

### REMOVABLE COVER VERSION FEATURES.

Completely removable upholstery. In leather, seat, back and auxiliary cushions with removable covers.

Wooden frame covered with flexible cold shaped polyurethane foam and polyester fibre.

Seat cushions in different polyurethane foam densities, with surface padding in fibre. Back cushions stuffed with polyester fibre and washed, sterilised down.

Metal bases coated in polyester powder paint with a manganese topcoat and LDPE stops.

**Removable upholstery option +15%**

**Option déhoussable +15%**

**Opción desenfundable +15%**

82

Tapiserie déhoussable sur les coussins de l'assise, coussins du dossier et coussins auxiliaires.

Cadre en bois recouvert de mousse de polyuréthane souple à froid et de fibre de polyester.

Coussins de l'assise réalisés dans différentes densités de mousse polyuréthane, matelassés en surface avec du fibre. Coussins du dossier garnis de fibre de polyester et plumes lavées et stérilisées.

Bases métalliques recouverts en peinture polyester en poudre finition manganèse avec butées en PEBD.

TRAITS VERSION DÉHOUSSABLE. Tapiserie entièrement déhoussable. En cuir, coussins de l'assise, du dossier et auxiliaires déhoussables.

Cadre en bois recouvert de mousse de polyuréthane souple à froid et de fibre de polyester.

Coussins de l'assise réalisés dans différentes densités de mousse polyuréthane, matelassés en surface avec du fibre. Coussins du dossier garnis de fibre de polyester et plumes lavées et stérilisées.

Bases métalliques recouverts en peinture polyester en poudre finition manganèse avec butées en PEBD.

Tapicería desenfundable en cojines de asiento, cojines de respaldos y cojines auxiliares.

Bastidor de madera recubierto de espuma de poliuretano flexible en frío y fibra de poliéster.

Cojines de asiento realizados es distintas densidades de espuma de poliuretano, acolchado en la superficie con fibra. Cojines de respaldo rellenos de fibra de poliéster y pluma lavada y esterilizada.

Bases metálicas recubiertas en pintura poliéster en polvo acabado manganeso con topes de LDPE.

### CARACTERÍSTICAS VERSIÓN DESENFUNDABLE.

Tapicería totalmente desenfundable. En piel, en cojines de asiento, respaldos y auxiliares desenfundables.

Bastidor de madera recubierto de espuma de poliuretano flexible en frío y fibra de poliéster.

Cojines de asiento realizados es distintas densidades de espuma de poliuretano, acolchado en la superficie con fibra. Cojines de respaldo rellenos de fibra de poliéster y pluma lavada y esterilizada.

Bases metálicas recubiertas en pintura poliéster en polvo acabado manganeso con topes de LDPE.

## SENSO.

### GENERAL MEASUREMENTS. MESURES GÉNÉRALES. MEDIDAS GENERALES.

---

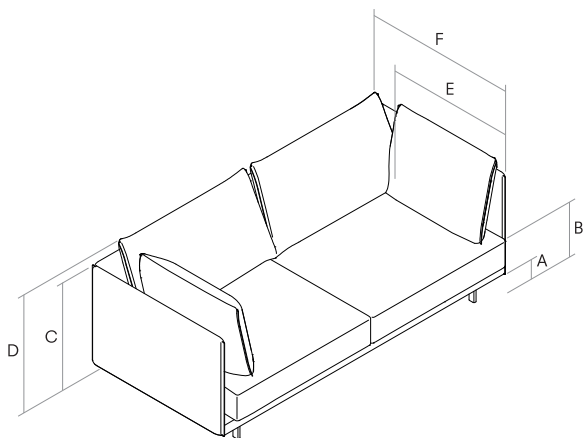

- A. Feet height. Hauteur du pied. Altura de la pata. 10 cm - 3.94"
- B. Seat height. Hauteur du siège. Altura de asiento. 42 cm - 16.54"
- C. Arm height. Hauteur du bras. Altura de brazo. 66 cm - 25.98"
- D. Backrest height. Hauteur du dossier. Altura de respaldo. 83 cm - 32.68"
- E. Seat depth. Profondeur d'assise. Profundidad de sentada. 60 cm - 23.62"
- F. Depth. Profondeur. Profundidad. 96 cm - 37.80"

### FINISHES. TRAITS. ACABADOS.

---

Finishes for the metal bases. Finitions des pieds métalliques. Acabados de las patas metálicas.

---

Polyester powder paint. Peinture polyester en poudre. Pintura poliéster en polvo.

---



Manganese metal.  
Métal manganèse.  
Metal manganeso.

## SENSO.

PRICES. PRIX. PRECIOS.

SENSO. Sofa. Canapé. Sofá.

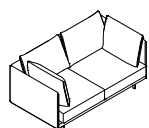

**SENS169BA**

169 x 96 H83  
66.54" x 37.80" H32.68"

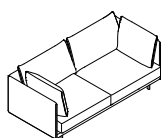

**SENS199BA**

199 x 96 H83  
78.35" x 37.80" H32.68"

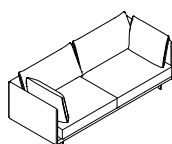

**SENS219BA**

219 x 96 H83  
86.22" x 37.80" H32.68"

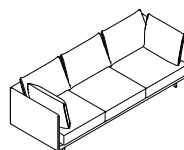

**SENS245BA**

245 x 96 H83  
96.46" x 37.80" H32.68"

| MEASUREMENT. MESURE. MEDIDA.           | REF.      | M.L. | COM / COL | 1        | 2        | 3        | 4        | 5        | L1       | L2       |
|--|-----------|------|-----------|----------|----------|----------|----------|----------|----------|----------|
| 169 x 96 H83   66.54" x 37.80" H32.68" | SENS169BA | 12.5 | 1.950,41  | 2.099,17 | 2.239,67 | 2.351,24 | 2.640,50 | 3.272,73 | 3.334,71 | 3.962,81 |
| 199 x 96 H83   78.35" x 37.80" H32.68" | SENS199BA | 12.5 | 2.099,17  | 2.202,48 | 2.367,77 | 2.537,19 | 2.896,69 | 3.595,04 | 3.657,02 | 4.272,73 |
| 219 x 96 H83   86.22" x 37.80" H32.68" | SENS219BA | 13   | 2.177,69  | 2.318,18 | 2.475,21 | 2.623,97 | 2.954,55 | 3.665,29 | 3.764,46 | 4.338,84 |
| 245 x 96 H83   96.46" x 37.80" H32.68" | SENS245BA | 16   | 2.545,45  | 2.702,48 | 2.929,75 | 3.148,76 | 3.516,53 | 4.421,49 | 4.500,00 | 5.206,61 |

SENSO. Sofas with 1 arm. Canapés avec 1 accoudoir. Sofás con 1 brazo.

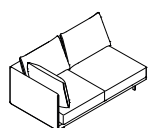

**SENSI161BA**

161 x 96 H83  
63.39" x 37.80" H32.68"  
IZQ.

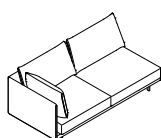

**SENSI191BA**

191 x 96 H83  
75.20" x 37.80" H32.68"  
IZQ.

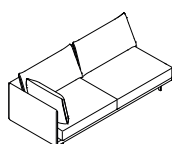

**SENSI211BA**

211 x 96 H83  
83.07" x 37.80" H32.68"  
IZQ.

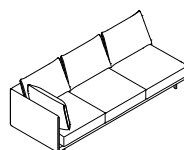

**SENSI237BA**

237 x 96 H83  
93.31" x 37.80" H32.68"  
IZQ.

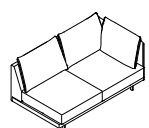

**SENSD161BA**

161 x 96 H83  
63.39" x 37.80" H32.68"  
DER.

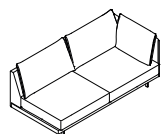

**SENSD191BA**

191 x 96 H83  
75.20" x 37.80" H32.68"  
DER.

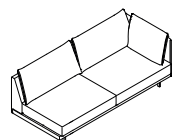

**SENSD211BA**

211 x 96 H83  
83.07" x 37.80" H32.68"  
DER.

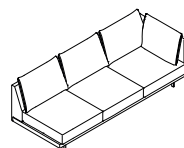

**SENSD237BA**

237 x 96 H83  
93.31" x 37.80" H32.68"  
DER.

| MEASUREMENT. MESURE. MEDIDA.           | REF.                    | M.L. | COM / COL | 1        | 2        | 3        | 4        | 5        | L1       | L2       |
|--|-------------------------|------|-----------|----------|----------|----------|----------|----------|----------|----------|
| 161 x 96 H83   63.39" x 37.80" H32.68" | SENSI161BA - SENSD161BA | 10.5 | 1.756,20  | 1.859,50 | 2.000,00 | 2.148,76 | 2.413,22 | 2.954,55 | 3.061,98 | 3.500,00 |
| 191 x 96 H83   75.20" x 37.80" H32.68" | SENSI191BA - SENSD191BA | 11.5 | 1.950,41  | 2.082,64 | 2.247,93 | 2.404,96 | 2.710,74 | 3.334,71 | 3.429,75 | 3.971,07 |
| 211 x 96 H83   83.07" x 37.80" H32.68" | SENSI211BA - SENSD211BA | 12   | 2.037,19  | 2.140,50 | 2.318,18 | 2.475,21 | 2.805,79 | 3.429,75 | 3.524,79 | 4.086,78 |
| 237 x 96 H83   93.31" x 37.80" H32.68" | SENSI237BA - SENSD237BA | 15   | 2.359,50  | 2.500,00 | 2.710,74 | 2.938,02 | 3.305,79 | 4.132,23 | 4.210,74 | 4.900,83 |

## SENSO.

### PRICES. PRIX. PRECIOS.

#### SENSO. Sofas without arms. Canapés sans accoudoirs. Sofás sin brazos.

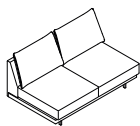

#### SENS0152

152 x 96 H83  
59.84" x 37.80" H32.68"

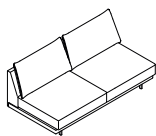

#### SENS0182

182 x 96 H83  
71.65" x 37.80" H32.68"

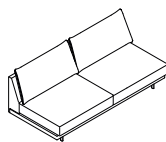

#### SENS0202

202 x 96 H83  
79.53" x 37.80" H32.68"

| MEASUREMENT. MESURE. MEDIDA.           | REF.     | M.L. | COM / COL | 1        | 2        | 3        | 4        | 5        | L1       | L2       |
|--|----------|------|-----------|----------|----------|----------|----------|----------|----------|----------|
| 152 x 96 H83   59.84" x 37.80" H32.68" | SENS0152 | 8    | 1.504,13  | 1.615,70 | 1.731,40 | 1.826,45 | 2.061,98 | 2.528,93 | 2.607,44 | 3.037,19 |
| 182 x 96 H83   71.65" x 37.80" H32.68" | SENS0182 | 8.5  | 1.677,69  | 1.793,39 | 1.896,69 | 2.028,93 | 2.247,93 | 2.702,48 | 2.805,79 | 3.202,48 |
| 202 x 96 H83   79.53" x 37.80" H32.68" | SENS0202 | 10   | 1.772,73  | 1.871,90 | 1.983,47 | 2.107,44 | 2.318,18 | 2.805,79 | 2.904,96 | 3.314,05 |

#### SENSO. Corners. Angles. Rincones.

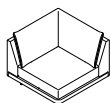

#### SENR96

96 x 96 H83  
37.80" x 37.80" H32.68"

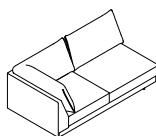

#### SENR187

187 x 96 H83  
73.62" x 37.80" H32.68"  
IZQ.

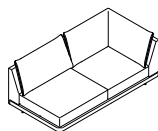

#### SENRD187

187 x 96 H83  
73.62" x 37.80" H32.68"  
DER.

| MEASUREMENT. MESURE. MEDIDA.           | REF.               | M.L. | COM / COL | 1        | 2        | 3        | 4        | 5        | L1       | L2       |
|--|--------------------|------|-----------|----------|----------|----------|----------|----------|----------|----------|
| 96 x 96 H83   37.80" x 37.80" H32.68"  | SENR96             | 6.5  | 1.371,90  | 1.458,68 | 1.537,19 | 1.632,23 | 1.818,18 | 2.185,95 | 2.264,46 | 2.586,78 |
| 187 x 96 H83   73.62" x 37.80" H32.68" | SENR187 - SENRD187 | 10   | 1.958,68  | 2.082,64 | 2.202,48 | 2.359,50 | 2.669,42 | 3.272,73 | 3.404,96 | 3.929,75 |

#### SENSO. Chaise longue.

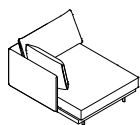

#### SENCLI105BA

105 x 155 H83  
41.34" x 61.02" H32.68"  
IZQ.

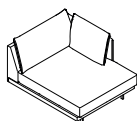

#### SENCLD105BA

105 x 155 H83  
41.34" x 61.02" H32.68"  
DER.

| MEASUREMENT. MESURE. MEDIDA.            | REF.                      | M.L. | COM / COL | 1        | 2        | 3        | 4        | 5        | L1       | L2       |
|---|---------------------------|------|-----------|----------|----------|----------|----------|----------|----------|----------|
| 105 x 155 H83   41.34" x 61.02" H32.68" | SENCLI105BA - SENCLD105BA | 9    | 1.710,74  | 1.801,65 | 1.942,15 | 2.082,64 | 2.326,45 | 2.826,45 | 2.921,49 | 3.351,24 |

SENSO.

FINISHES. TRAITS. ACABADOS.

---

Ottomans. Leather finish for the tray. Poufs. Finition en cuir du plateau. Ottoman. Acabados en piel para la bandeja.

---

Leather. Cuir. Piel.

---



NUVOLA  
199



NUVOLA  
163



ELMOBALTIQUE  
88042



NUVOLA  
155



NUVOLA  
151



NUVOLA  
147



ELMOBALTIQUE  
33280



ELMOBALTIQUE  
43003



ELMOBALTIQUE  
99011

SENSO.

PRICES. PRIX. PRECIOS.

SENSO. Ottomans. Poufs. Ottomans.



**SENP76**

76 x 96 H42  
29.92"x 37.80" H16.54"

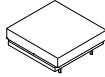

**SENP91**

91 x 96 H42  
35.83"x 37.80" H16.54"

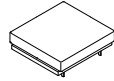

**SENP101**

101 x 96 H42  
39.76"x 37.80" H16.54"



**SENP76BJ**

76 x 96 H42  
29.92"x 37.80" H16.54"

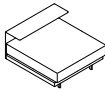

**SENP91BJ**

91 x 96 H42  
35.83"x 37.80" H16.54"

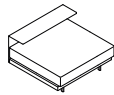

**SENP101BJ**

101 x 96 H42  
39.76"x 37.80" H16.54"

| MEASUREMENT. MESURE. MEDIDA.          | REF.      | M.L.        | COM / COL | 1        | 2        | 3        | 4        | 5        | L1       | L2       |
|---------------------------------------|-----------|-------------|-----------|----------|----------|----------|----------|----------|----------|----------|
| 76 x 96 H42   29.92"x 37.80" H16.54"  | SENP76    | 3           | 698,35    | 723,14   | 776,86   | 793,39   | 888,43   | 1.020,66 | 1.053,72 | 1.185,95 |
| 91 x 96 H42   35.83"x 37.80" H16.54"  | SENP91    | 3.5         | 747,93    | 776,86   | 818,18   | 888,43   | 933,88   | 1.107,44 | 1.144,63 | 1.264,46 |
| 101 x 96 H42   39.76"x 37.80" H16.54" | SENP101   | 3.5         | 785,12    | 818,18   | 834,71   | 904,96   | 983,47   | 1.144,63 | 1.161,16 | 1.318,18 |
| 76 x 96 H55   29.92"x 37.80" H21.65"  | SENP76BJ  | 3,00 + 1,00 | 904,96    | 950,41   | 995,87   | 1.053,72 | 1.152,89 | 1.363,64 | 1.404,96 | 1.607,44 |
| 91 x 96 H55   35.83"x 37.80" H21.65"  | SENP91BJ  | 3,50 + 1,50 | 950,41    | 1.004,13 | 1.053,72 | 1.123,97 | 1.231,40 | 1.458,68 | 1.475,21 | 1.677,69 |
| 101 x 96 H55   39.76"x 37.80" H21.65" | SENP101BJ | 3,50 + 1,50 | 1.004,13  | 1.053,72 | 1.123,97 | 1.177,69 | 1.301,65 | 1.553,72 | 1.590,91 | 1.826,45 |

# SERENE.

# SOFA. CANAPÉ. SOFÁ.



Designer  
Mario Ruiz

STYLE. ESTILO.  
Singular

VERSION. VERSIÓN.  
Suspended base. Base suspendue. Base suspendida.

VARIANTS. VARIANTES.  
Standard depth. Profondeur standard. Profundidad estándar. (98 cm - 38.58 in)  
High arm. Accoudoir haut. Brazo alto.

## FEATURES. TRAITS. CARACTERÍSTICAS.

**The high backrest costs an extra 47 euros per unit. Le dossier haut coûte 47 euros de plus par unité. El respaldo alto tiene un coste extra de 47 euros por unidad.**

Removable upholstery in seat, back and auxiliary cushions.

Wooden frame covered with flexible cold shaped polyurethane foam and polyester fibre.

Suspension consisting of fibreglass reinforced plastic slats.

Seat cushions in different polyurethane foam densities, with surface padding in fibre. Back cushions stuffed with polyester fibre and washed, sterilised down. Auxiliary cushions stuffed with polyester fibre and washed, sterilised down.

Metal bases coated in polyester powder paint with a manganese topcoat and LDPE stops.

Two back cushion heights available: Standard (82 cm - 32.28 in) or High (92 cm - 36.22)

Tapiserie déhoussable sur les coussins de l'assise, coussins du dossier et coussins auxiliaires.

Cadre en bois recouvert de mousse de polyuréthane souple à froid et de fibre de polyester.

Suspension au moyen de lattes renforcées avec de la fibre de verre.

Coussins de l'assise réalisés dans différentes densités de mousse polyuréthane, matelassés en surface avec du fibre. Coussins du dossier garnis de fibre de polyester et plumes lavées et stérilisées. Coussins auxiliaires garnis de fibre de polyester et plumes lavées et stérilisées.

Bases métalliques recouverts en peinture polyester en poudre finition manganèse avec butées en PEBD.

Deux hauteurs de coussin pour les dossiers disponibles : Standard (82 cm) ou Haut (92 cm)

Tapicería desenfundable en cojines de asiento, cojines de respaldo y cojines auxiliares.

Bastidor de madera recubierto de espuma de poliuretano flexible en frío y fibra de poliéster.

Suspensión mediante lamas de plástico reforzadas con fibra de vidrio.

Cojines de asiento realizados en distintas densidades de espuma de poliuretano, acolchado en la superficie con fibra. Cojines de respaldo rellenos de fibra de poliéster y pluma lavada y esterilizada. Cojines auxiliares rellenos de fibra de poliéster y pluma lavada y esterilizada.

Bases metálicas recubiertas en pintura poliéster en polvo acabado manganeso con topes de LDPE.

Dos alturas de respaldo disponibles: Estándar (82 cm) o Alto (92 cm)



## SERENE.

### GENERAL MEASUREMENTS. MESURES GÉNÉRALES. MEDIDAS GENERALES.

---

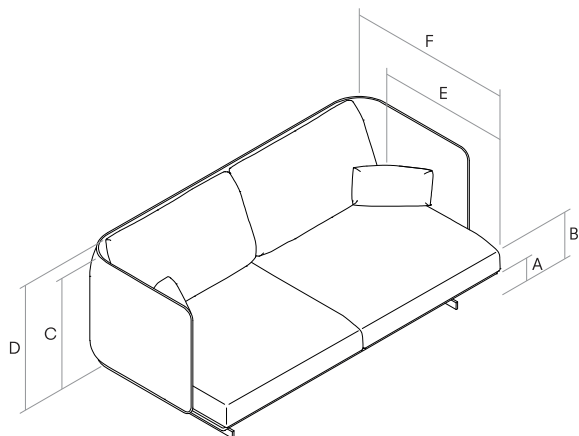

- A. Base height. Hauteur de base. Altura de base. 13 cm - 5.12"
- B. Seat height. Hauteur du siège. Altura de asiento. 42 cm - 16.54"
- C. Arm height. Hauteur du bras. Altura de brazo. 77 cm - 30.31"
- D. Backrest height. Hauteur du dossier. Altura de respaldo. 82 cm - 32.28"
- E. Seat depth. Profondeur d'assise. Profundidad de sentada. 58 cm - 22.83"
- F. Depth. Profondeur. Profundidad. 98 cm - 38.58"

### FINISHES. TRAITS. ACABADOS.

---

Finishes for the metal bases. Finitions des pieds métalliques. Acabados de las patas metálicas.

---

Polyester powder paint. Peinture polyester en poudre. Pintura poliéster en polvo.

---



Manganese metal.  
Métal manganèse.  
Metal manganeso.

### OPTIONAL BACK CUSHIONS. COUSSINS DU DOSSIER EN OPTION. COJINES DE RESPALDO OPCIONALES.

---

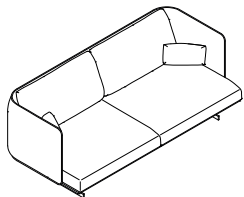

Standard option. Option standard. Opción estándar.  
Backrest height. Hauteur du dossier. Altura de respaldo.  
**82 cm - 32.28"**

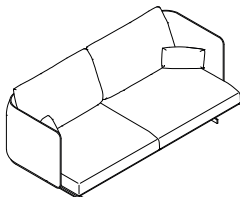

Premium option. Option premium. Opción premium.  
Backrest height. Hauteur du dossier. Altura de respaldo.  
**92 cm - 36.22"**

## SERENE.

### FINISHES. TRAITS. ACABADOS.

Wood finishes. Finitions bois. Acabado de la madera.



**RN**  
Natural oak.  
Chêne naturel.  
Roble natural.



**NA**  
Natural american walnut.  
Noyer américain.  
Nogal americano.



**RT**  
Dark stained oak.  
Chêne teint foncée.  
Roble teñido oscuro.



**RL**  
Oak painted in black with open-pore finish.  
Chêne laqué noir à pores ouverts.  
Roble lacado negro por abierto.

Lacquered. Laqué. Lacados.



SEDA



ALOE



KHAKI



BRICK



RUBI



KOKOA

## CONFIGURATOR.

Compatibility between furniture and upholstered elements. Compatibilité entre les meubles et les éléments tapissés. Compatibilidad entre mobiliario y elementos tapizados.

|  | REFERENCE       | Supported references. Références compatibles. Referencias compatibles. |                                   |              |
|--|-----------------|--|-----------------------------------|--------------|
|  | <b>SERMU149</b> | SERS170BSPSBA  | SERSI165BSPSBA - SERSD165BSPSBA   | SERS0160BSPS |
|  | <b>SERMU169</b> | SERS190BSPSBA  | SERSI185BSPSBA - SERSD185BSPSBA   | SERS0180BSPS |
|  | <b>SERMU189</b> | SERS210BSPSBA  |                                   |              |
|  | <b>SERMU209</b> | SERS230BSPSBA  |                                   |              |
|  | <b>SERMU229</b> | SERS250BSPSBA  | SERSI245BSPSBA - SERSD245BSPSBA   | SERS0240BSPS |
|  | <b>SERMU162</b> | SERRI174BSPS - SERRD174BSPS  | SERSRI263BSPSBA - SERSRD263BSPSBA |              |
|  | <b>SERMU172</b> | SERRI184BSPS - SERRD184BSPS  | SERSRI283BSPSBA - SERSRD283BSPSBA |              |
|  | <b>SERMU83</b>  | SERCLI98BSPSBA - SERCLD98BSPSBA  |                                   |              |
|  | <b>SERMU93</b>  | SERCLI108BSPSBA - SERCLD108BSPSBA                                      |                                   |              |

## SERENE.

### PRICES. PRIX. PRECIOS.

SERENE. Sofa. Canapé. Sofá.



**SERS170BSPSBA**

170 x 98 H82  
66.93" x 38.58" H32.28"



**SERS190BSPSBA**

190 x 98 H82  
74.80" x 38.58" H32.28"

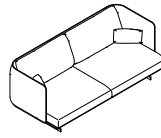

**SERS210BSPSBA**

210 x 98 H82  
82.68" x 38.58" H32.28"

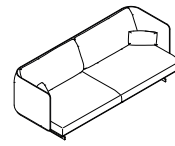

**SERS230BSPSBA**

230 x 98 H82  
90.55" x 38.58" H32.28"

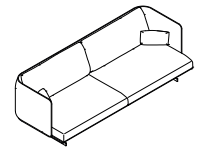

**SERS250BSPSBA**

250 x 98 H82  
98.43" x 38.58" H32.28"

| MEASUREMENT. MESURE. MEDIDA.           | REF.          | M.L. | COM / COL | 1        | 2        | 3        | 4        | 5        | L1       | L2       |
|--|---------------|------|-----------|----------|----------|----------|----------|----------|----------|----------|
| 170 x 98 H82   66.93" x 38.58" H32.28" | SERS170BSPSBA | 11.5 | 2.607,44  | 2.702,48 | 2.842,98 | 3.008,26 | 3.305,79 | 3.867,77 | 3.991,74 | 4.541,32 |
| 190 x 98 H82   74.80" x 38.58" H32.28" | SERS190BSPSBA | 11.5 | 2.739,67  | 2.826,45 | 2.975,21 | 3.132,23 | 3.438,02 | 3.983,47 | 4.111,57 | 4.665,29 |
| 210 x 98 H82   82.68" x 38.58" H32.28" | SERS210BSPSBA | 12   | 2.842,98  | 2.938,02 | 3.086,78 | 3.243,80 | 3.533,06 | 4.086,78 | 4.210,74 | 4.743,80 |
| 230 x 98 H82   90.55" x 38.58" H32.28" | SERS230BSPSBA | 12   | 3.140,50  | 3.235,54 | 3.392,56 | 3.533,06 | 3.851,24 | 4.400,83 | 4.533,06 | 5.086,78 |
| 250 x 98 H82   98.43" x 38.58" H32.28" | SERS250BSPSBA | 12.5 | 3.413,22  | 3.508,26 | 3.665,29 | 3.830,58 | 4.157,02 | 4.743,80 | 4.867,77 | 5.462,81 |

SERENE. Tables for sofas with 1 arm, without arms and corners. Tables pour canapés avec 1 accoudoir, sans accoudoirs et angles. Mesas para sofás con un brazo, sin brazos y rincones.



**SERME38**

38 x 92 H16  
14.96" x 36.22" H6.30"



**SERME94**

94 x 89 H16  
37.01" x 35.04" H6.30"

| MEASUREMENT. MESURE. MEDIDA.         | FINISHES. TRAITS. ACABADOS.   | REF.      | PRICE. PRIX. PRECIO. |
|--------------------------------------|---|-----------|----------------------|
| 38 x 92 H16   14.96" x 36.22" H6.30" | Natural oak. Chêne naturel. Roble natural.  | SERME38RN | 756,20               |
| 38 x 92 H16   14.96" x 36.22" H6.30" | American walnut. Noyer américain. Nogal americano.  | SERME38NA | 814,05               |
| 38 x 92 H16   14.96" x 36.22" H6.30" | Dark stained oak. Chêne teinté foncé. Roble teñido oscuro.  | SERME38RT | 756,20               |
| 38 x 92 H16   14.96" x 36.22" H6.30" | Oak painted in black with open-pore finish. Chêne laqué noir à pores ouverts. Roble lacado negro por abierto. | SERME38RL | 814,05               |
| 38 x 92 H16   14.96" x 36.22" H6.30" | Matt lacquer. Laque mate. Lacado mate.  | SERME38LA | 756,20               |
| 94 x 89 H16   37.01" x 35.04" H6.30" | Natural oak. Chêne naturel. Roble natural.  | SERME94RN | 888,43               |
| 94 x 89 H16   37.01" x 35.04" H6.30" | American walnut. Noyer américain. Nogal americano.  | SERME94NA | 962,81               |
| 94 x 89 H16   37.01" x 35.04" H6.30" | Dark stained oak. Chêne teinté foncé. Roble teñido oscuro.  | SERME94RT | 888,43               |
| 94 x 89 H16   37.01" x 35.04" H6.30" | Oak painted in black with open-pore finish. Chêne laqué noir à pores ouverts. Roble lacado negro por abierto. | SERME94RL | 962,81               |
| 94 x 89 H16   37.01" x 35.04" H6.30" | Matt lacquer. Laque mate. Lacado mate.  | SERME94LA | 888,43               |

## SERENE.

### PRICES. PRIX. PRECIOS.

SERENE. Furniture for sofas, sofas with 1 arm, and without arms. Meubles pour canapés, canapés avec 1 accoudoir et sans accoudoirs. Muebles para sofás, para sofás con 1 brazo y para sofás sin brazos.



**SERMU149**

149 x 25 H43

63.78" x 9.84" H16.93"



**SERMU169**

169 x 25 H43

66.54" x 9.84" H16.93"

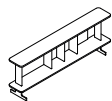

**SERMU189**

189 x 25 H43

74.41" x 9.84" H16.93"

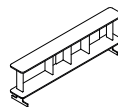

**SERMU209**

209 x 25 H43

82.28" x 9.84" H16.93"

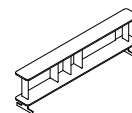

**SERMU229**

229 x 25 H43

90.16" x 9.84" H16.93"

| MEASUREMENT. MESURE. MEDIDA.            | FINISHES. TRAITS. ACABADOS.   | REF.       | PRICE. PRIX. PRECIO. |
|---|---|------------|----------------------|
| 149 x 25 H43   63.78" x 9.84"   H16.93" | Natural oak. Chêne naturel. Roble natural.  | SERMU149RN | 1.161,16             |
| 149 x 25 H43   63.78" x 9.84"   H16.93" | American walnut. Noyer américain. Nogal americano.  | SERMU149NA | 1.256,20             |
| 149 x 25 H43   63.78" x 9.84"   H16.93" | Dark stained oak. Chêne teinté foncé. Roble teñido oscuro.  | SERMU149RT | 1.161,16             |
| 149 x 25 H43   63.78" x 9.84"   H16.93" | Oak painted in black with open-pore finish. Chêne laqué noir à pores ouverts. Roble lacado negro por abierto. | SERMU149RL | 1.256,20             |
| 149 x 25 H43   63.78" x 9.84"   H16.93" | Matt lacquer. Laque mate. Lacado mate.  | SERMU149LA | 1.161,16             |
| 169 x 25 H43   66.54" x 9.84"   H16.93" | Natural oak. Chêne naturel. Roble natural.  | SERMU169RN | 1.235,54             |
| 169 x 25 H43   66.54" x 9.84"   H16.93" | American walnut. Noyer américain. Nogal americano.  | SERMU169NA | 1.342,98             |
| 169 x 25 H43   66.54" x 9.84"   H16.93" | Dark stained oak. Chêne teinté foncé. Roble teñido oscuro.  | SERMU169RT | 1.235,54             |
| 169 x 25 H43   66.54" x 9.84"   H16.93" | Oak painted in black with open-pore finish. Chêne laqué noir à pores ouverts. Roble lacado negro por abierto. | SERMU169RL | 1.342,98             |
| 169 x 25 H43   66.54" x 9.84"   H16.93" | Matt lacquer. Laque mate. Lacado mate.  | SERMU169LA | 1.235,54             |
| 189 x 25 H43   74.41" x 9.84"   H16.93" | Natural oak. Chêne naturel. Roble natural.  | SERMU189RN | 1.355,37             |
| 189 x 25 H43   74.41" x 9.84"   H16.93" | American walnut. Noyer américain. Nogal americano.  | SERMU189NA | 1.442,15             |
| 189 x 25 H43   74.41" x 9.84"   H16.93" | Dark stained oak. Chêne teinté foncé. Roble teñido oscuro.  | SERMU189RT | 1.322,31             |
| 189 x 25 H43   74.41" x 9.84"   H16.93" | Oak painted in black with open-pore finish. Chêne laqué noir à pores ouverts. Roble lacado negro por abierto. | SERMU189RL | 1.442,15             |
| 189 x 25 H43   74.41" x 9.84"   H16.93" | Matt lacquer. Laque mate. Lacado mate.  | SERMU189LA | 1.322,31             |
| 209 x 25 H43   82.28" x 9.84"   H16.93" | Natural oak. Chêne naturel. Roble natural.  | SERMU209RN | 1.396,69             |
| 209 x 25 H43   82.28" x 9.84"   H16.93" | American walnut. Noyer américain. Nogal americano.  | SERMU209NA | 1.495,87             |
| 209 x 25 H43   82.28" x 9.84"   H16.93" | Dark stained oak. Chêne teinté foncé. Roble teñido oscuro.  | SERMU209RT | 1.396,69             |
| 209 x 25 H43   82.28" x 9.84"   H16.93" | Oak painted in black with open-pore finish. Chêne laqué noir à pores ouverts. Roble lacado negro por abierto. | SERMU209RL | 1.495,87             |
| 209 x 25 H43   82.28" x 9.84"   H16.93" | Matt lacquer. Laque mate. Lacado mate.  | SERMU209LA | 1.396,69             |
| 229 x 25 H43   90.16" x 9.84"   H16.93" | Natural oak. Chêne naturel. Roble natural.  | SERMU229RN | 1.508,26             |
| 229 x 25 H43   90.16" x 9.84"   H16.93" | American walnut. Noyer américain. Nogal americano.  | SERMU229NA | 1.603,31             |
| 229 x 25 H43   90.16" x 9.84"   H16.93" | Dark stained oak. Chêne teinté foncé. Roble teñido oscuro.  | SERMU229RT | 1.508,26             |
| 229 x 25 H43   90.16" x 9.84"   H16.93" | Oak painted in black with open-pore finish. Chêne laqué noir à pores ouverts. Roble lacado negro por abierto. | SERMU229RL | 1.603,31             |
| 229 x 25 H43   90.16" x 9.84"   H16.93" | Matt lacquer. Laque mate. Lacado mate.  | SERMU229LA | 1.508,26             |

## SERENE.

### PRICES. PRIX. PRECIOS.

SERENE. Furniture for chaise longue. Meubles pour chaise longue. Muebles para chaise longue.



#### SERMU83

83 x 25 H43  
32.68" x 9.84" H16.93"



#### SERMU93

93 x 25 H43  
36.61" x 9.84" H16.93"

| MEASUREMENT. MESURE. MEDIDA.         | FINISHES. TRAITS. ACABADOS.   | REF.      | PRICE. PRIX. PRECIO. |
|--------------------------------------|---|-----------|----------------------|
| 83 x 25 H43   32.68" x 9.84" H16.93" | Natural oak. Chêne naturel. Roble natural.  | SERMU83RN | 954,55               |
| 83 x 25 H43   32.68" x 9.84" H16.93" | American walnut. Noyer américain. Nogal americano.  | SERMU83NA | 1.020,66             |
| 83 x 25 H43   32.68" x 9.84" H16.93" | Dark stained oak. Chêne teinté foncé. Roble teñido oscuro.  | SERMU83RT | 954,55               |
| 83 x 25 H43   32.68" x 9.84" H16.93" | Oak painted in black with open-pore finish. Chêne laqué noir à pores ouverts. Roble lacado negro por abierto. | SERMU83RL | 1.020,66             |
| 83 x 25 H43   32.68" x 9.84" H16.93" | Matt lacquer. Laque mate. Lacado mate.  | SERMU83LA | 954,55               |
| 93 x 25 H43   36.61" x 9.84" H16.93" | Natural oak. Chêne naturel. Roble natural.  | SERMU93RN | 987,60               |
| 93 x 25 H43   36.61" x 9.84" H16.93" | American walnut. Noyer américain. Nogal americano.  | SERMU93NA | 1.041,32             |
| 93 x 25 H43   36.61" x 9.84" H16.93" | Dark stained oak. Chêne teinté foncé. Roble teñido oscuro.  | SERMU93RT | 987,60               |
| 93 x 25 H43   36.61" x 9.84" H16.93" | Oak painted in black with open-pore finish. Chêne laqué noir à pores ouverts. Roble lacado negro por abierto. | SERMU93RL | 1.041,32             |
| 93 x 25 H43   36.61" x 9.84" H16.93" | Matt lacquer. Laque mate. Lacado mate.  | SERMU93LA | 987,60               |

SERENE. Furniture for corner and sofa corner. Meubles pour angle et canapé angle. Muebles para rincón y sofá rincón.



#### SERMU162

162 x 25 H43  
63.78" x 9.84" H16.93"

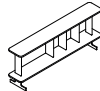

#### SERMU172

172 x 25 H43  
67.72" x 9.84" H16.93"

| MEASUREMENT. MESURE. MEDIDA.          | FINISHES. TRAITS. ACABADOS.   | REF.       | PRICE. PRIX. PRECIO. |
|---------------------------------------|---|------------|----------------------|
| 162 x 25 H43   63.78" x 9.84" H16.93" | Natural oak. Chêne naturel. Roble natural.  | SERMU162RN | 1.214,88             |
| 162 x 25 H43   63.78" x 9.84" H16.93" | American walnut. Noyer américain. Nogal americano.  | SERMU162NA | 1.314,05             |
| 162 x 25 H43   63.78" x 9.84" H16.93" | Dark stained oak. Chêne teinté foncé. Roble teñido oscuro.  | SERMU162RT | 1.214,88             |
| 162 x 25 H43   63.78" x 9.84" H16.93" | Oak painted in black with open-pore finish. Chêne laqué noir à pores ouverts. Roble lacado negro por abierto. | SERMU162RL | 1.314,05             |
| 162 x 25 H43   63.78" x 9.84" H16.93" | Matt lacquer. Laque mate. Lacado mate.  | SERMU162LA | 1.214,88             |
| 172 x 25 H43   67.72" x 9.84" H16.93" | Natural oak. Chêne naturel. Roble natural.  | SERMU172RN | 1.293,39             |
| 172 x 25 H43   67.72" x 9.84" H16.93" | American walnut. Noyer américain. Nogal americano.  | SERMU172NA | 1.421,49             |
| 172 x 25 H43   67.72" x 9.84" H16.93" | Dark stained oak. Chêne teinté foncé. Roble teñido oscuro.  | SERMU172RT | 1.293,39             |
| 172 x 25 H43   67.72" x 9.84" H16.93" | Oak painted in black with open-pore finish. Chêne laqué noir à pores ouverts. Roble lacado negro por abierto. | SERMU172RL | 1.421,49             |
| 172 x 25 H43   67.72" x 9.84" H16.93" | Matt lacquer. Laque mate. Lacado mate.  | SERMU172LA | 1.293,39             |

SERENE.

PRICES. PRIX. PRECIOS.

SEAT CUSHION 80 CM. COUSSIN DE L'ASSISE DE 80 CM. COJÍN DE ASIENTO DE 80 CM.

SERENE. Sofas with 1 arm. Canapés avec 1 accoudoir. Sofás con 1 brazo.



**SERSI85BSPSBA**

85 x 98 H82  
33.46" x 38.58" H32.28"  
IZQ.

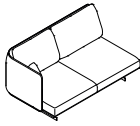

**SERSI165BSPSBA**

165 x 98 H82  
64.96" x 38.58" H32.28"  
IZQ.

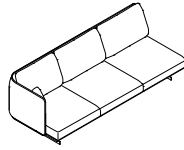

**SERSI245BSPSBA**

245 x 98 H82  
96.46" x 38.58" H32.28"  
IZQ.



**SERSD85BSPSBA**

85 x 98 H82  
33.46" x 38.58" H32.28"  
DER.



**SERSD165BSPSBA**

165 x 98 H82  
64.96" x 38.58" H32.28"  
DER.

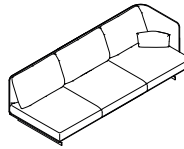

**SERSD245BSPSBA**

245 x 98 H82  
96.46" x 38.58" H32.28"  
DER.

| MEASUREMENT. MESURE. MEDIDA.           | REF.                            | M.L. | COM / COL | 1        | 2        | 3        | 4        | 5        | L1       | L2       |
|--|---------------------------------|------|-----------|----------|----------|----------|----------|----------|----------|----------|
| 85 x 98 H82   33.46" x 38.58" H32.28"  | SERSI85BSPSBA - SERSD85BSPSBA   | 7    | 1.607,44  | 1.652,89 | 1.731,40 | 1.801,65 | 1.966,94 | 2.239,67 | 2.309,92 | 2.578,51 |
| 165 x 98 H82   64.96" x 38.58" H32.28" | SERSI165BSPSBA - SERSD165BSPSBA | 10   | 2.413,22  | 2.491,74 | 2.623,97 | 2.772,73 | 3.037,19 | 3.524,79 | 3.640,50 | 4.132,23 |
| 245 x 98 H82   96.46" x 38.58" H32.28" | SERSI245BSPSBA - SERSD245BSPSBA | 15   | 3.351,24  | 3.475,21 | 3.657,02 | 3.859,50 | 4.252,07 | 4.954,55 | 5.111,57 | 5.814,05 |

SERENE. Sofas without arms. Canapés sans accoudoirs. Sofás sin brazos.



**SERS080BSPS**

80 x 98 H82  
31.50" x 38.58" H32.28"

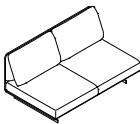

**SERS0160BSPS**

160 x 98 H82  
62.99" x 38.58" H32.28"

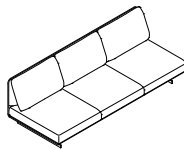

**SERS0240BSPS**

240 x 98 H82  
94.49" x 38.58" H32.28"

| MEASUREMENT. MESURE. MEDIDA.           | REF.         | M.L. | COM / COL | 1        | 2        | 3        | 4        | 5        | L1       | L2       |
|--|--------------|------|-----------|----------|----------|----------|----------|----------|----------|----------|
| 80 X 98 H82   31.50" x 38.58" H32.28"  | SERS080BSPS  | 6    | 1.458,68  | 1.491,74 | 1.553,72 | 1.623,97 | 1.739,67 | 1.958,68 | 2.000,00 | 2.231,40 |
| 160 x 98 H82   62.99" x 38.58" H32.28" | SERS0160BSPS | 9.5  | 2.247,93  | 2.309,92 | 2.438,02 | 2.561,98 | 2.789,26 | 3.235,54 | 3.305,79 | 3.743,80 |
| 240 x 98 H82   94.49" x 38.58" H32.28" | SERS0240BSPS | 14.5 | 3.140,50  | 3.256,20 | 3.421,49 | 3.603,31 | 3.962,81 | 4.595,04 | 4.743,80 | 5.376,03 |

SERENE.

PRICES. PRIX. PRECIOS.

SEAT CUSHION 80 CM. COUSSIN DE L'ASSISE DE 80 CM. COJÍN DE ASIENTO DE 80 CM.

SERENE. Corner and sofa corner. Angle et canapé angle. Rincón y sofá rincón.

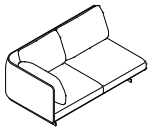

**SERRI174BSPS**

174 x 98 H82  
68.50" x 38.58" H32.28"  
IZQ.

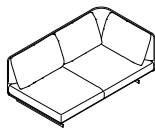

**SERRD174BSPS**

174 x 98 H82  
68.50" x 38.58" H32.28"  
DER.

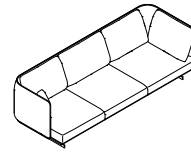

**SERSRI263BSPSBA**

263 x 98 H82  
103.54" x 38.58" H32.28"  
IZQ.

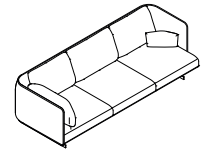

**SERSRD263BSPSBA**

263 x 98 H82  
103.54" x 38.58" H32.28"  
DER.

| MEASUREMENT. MESURE. MEDIDA.            | REF.                              | M.L. | COM / COL | 1        | 2        | 3        | 4        | 5        | L1       | L2       |
|---|-----------------------------------|------|-----------|----------|----------|----------|----------|----------|----------|----------|
| 174 x 98 H82   68.50" x 38.58" H32.28"  | SERRI174BSPS - SERRD174BSPS       | 11   | 2.685,95  | 2.772,73 | 2.913,22 | 3.070,25 | 3.367,77 | 3.913,22 | 4.024,79 | 4.578,51 |
| 263 x 98 H82   103.54" x 38.58" H32.28" | SERSRI263BSPSBA - SERSRD263BSPSBA | 15.5 | 3.657,02  | 3.789,26 | 4.008,26 | 4.252,07 | 4.698,35 | 5.516,53 | 5.690,08 | 6.512,40 |

SERENE. Ottomans. Poufs. Ottomans.



**SERP80BSPS**

80 x 94 H42  
31.50" x 37.01" H16.54"

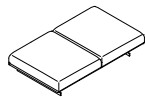

**SERP160BSPS**

160 x 94 H42  
62.99" x 37.01" H16.54"

| MEASUREMENT. MESURE. MEDIDA.           | REF.        | M.L. | COM / COL | 1        | 2        | 3        | 4        | 5        | L1       | L2       |
|--|-------------|------|-----------|----------|----------|----------|----------|----------|----------|----------|
| 80 x 94 H42   31.50" x 37.01" H16.54"  | SERP80BSPS  | 2.5  | 950,41    | 983,47   | 1.004,13 | 1.053,72 | 1.123,97 | 1.247,93 | 1.272,73 | 1.404,96 |
| 160 x 94 H42   62.99" x 37.01" H16.54" | SERP160BSPS | 4.5  | 1.590,91  | 1.607,44 | 1.661,16 | 1.731,40 | 1.834,71 | 2.020,66 | 2.090,91 | 2.272,73 |

SERENE. Chaise longues.

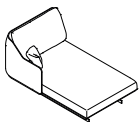

**SERCLI98BSPSBA**

98 x 160 H82  
38.58" x 62.99" H32.28"  
IZQ.

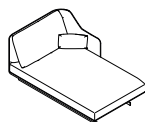

**SERCLD98BSPSBA**

98 x 160 H82  
38.58" x 62.99" H32.28"  
DER.

| MEASUREMENT. MESURE. MEDIDA.           | REF.                            | M.L. | COM / COL | 1        | 2        | 3        | 4        | 5        | L1       | L2       |
|--|---------------------------------|------|-----------|----------|----------|----------|----------|----------|----------|----------|
| 98 x 160 H82   38.58" x 62.99" H32.28" | SERCLI98BSPSBA - SERCLD98BSPSBA | 7.5  | 2.309,92  | 2.351,24 | 2.458,68 | 2.561,98 | 2.764,46 | 3.132,23 | 3.194,21 | 3.561,98 |

## SERENE.

PRICES. PRIX. PRECIOS.

SEAT CUSHION 90 CM. COUSSIN DE L'ASSISE DE 90 CM. COJÍN DE ASIENTO DE 90 CM.

SERENE. Sofas with 1 arm. Canapés avec 1 accoudoir. Sofás con 1 brazo.

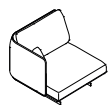

**SERSI95BSPSBA**

95 x 98 H82  
37.40" x 38.58" H32.28"  
IZQ.



**SERSI185BSPSBA**

185 x 98 H82  
72.83" x 38.58" H32.28"  
IZQ.

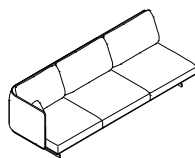

**SERSI275BSPSBA**

275 x 98 H82  
108.27" x 38.58" H32.28"  
IZQ.



**SERSD95BSPSBA**

95 x 98 H82  
37.40" x 38.58" H32.28"  
DER.

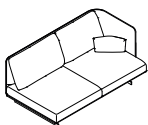

**SERSD185BSPSBA**

185 x 98 H82  
72.83" x 38.58" H32.28"  
DER.

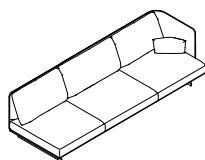

**SERSD275BSPSBA**

275 x 98 H82  
108.27" x 38.58" H32.28"  
DER.

| MEASUREMENT. MESURE. MEDIDA.            | REF.                            | M.L. | COM / COL | 1        | 2        | 3        | 4        | 5        | L1       | L2       |
|---|---------------------------------|------|-----------|----------|----------|----------|----------|----------|----------|----------|
| 95 x 98 H82   37.40" x 38.58" H32.28"   | SERSI95BSPSBA - SERSD95BSPSBA   | 8    | 1.694,21  | 1.739,67 | 1.801,65 | 1.896,69 | 2.061,98 | 2.334,71 | 2.404,96 | 2.685,95 |
| 185 x 98 H82   72.83" x 38.58" H32.28"  | SERSI185BSPSBA - SERSD185BSPSBA | 11   | 2.586,78  | 2.669,42 | 2.805,79 | 2.938,02 | 3.202,48 | 3.710,74 | 3.805,79 | 4.314,05 |
| 275 x 98 H82   108.27" x 38.58" H32.28" | SERSI275BSPSBA - SERSD275BSPSBA | 15.5 | 3.595,04  | 3.710,74 | 3.913,22 | 4.111,57 | 4.500,00 | 5.198,35 | 5.363,64 | 6.082,64 |

SERENE. Sofas without arms. Canapés sans accoudoirs. Sofás sin brazo.



**SERS090BSPS**

90 x 98 H82  
35.43" x 38.58" H32.28"

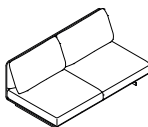

**SERS0180BSPS**

180 x 98 H82  
70.87" x 38.58" H32.28"

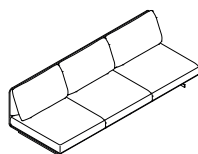

**SERS0270BSPS**

270 x 98 H82  
106.30" x 38.58" H32.28"

| MEASUREMENT. MESURE. MEDIDA.            | REF.         | M.L. | COM / COL | 1        | 2        | 3        | 4        | 5        | L1       | L2       |
|---|--------------|------|-----------|----------|----------|----------|----------|----------|----------|----------|
| 90 x 98 H82   35.43" x 38.58" H32.28"   | SERS090BSPS  | 7    | 1.537,19  | 1.590,91 | 1.652,89 | 1.702,48 | 1.842,98 | 2.090,91 | 2.123,97 | 2.359,50 |
| 180 x 98 H82   70.87" x 38.58" H32.28"  | SERS0180BSPS | 10.5 | 2.438,02  | 2.500,00 | 2.623,97 | 2.764,46 | 2.983,47 | 3.429,75 | 3.524,79 | 3.962,81 |
| 270 x 98 H82   106.30" x 38.58" H32.28" | SERS0270BSPS | 14.5 | 3.413,22  | 3.508,26 | 3.681,82 | 3.859,50 | 4.235,54 | 4.859,50 | 5.016,53 | 5.652,89 |



SERENE.

PRICES. PRIX. PRECIOS.

SEAT CUSHION 90 CM. COUSSIN DE L'ASSISE DE 90 CM. COJÍN DE ASIENTO DE 90 CM.

SERENE. Corner and sofa corner. Angle et canapé angle. Rincón y sofá rincón.

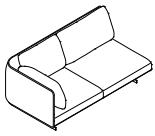

**SERRI184BSPS**

184 x 98 H82  
72.44" x 38.58" H32.28"  
IZQ.

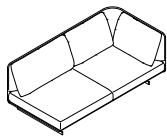

**SERRD184BSPS**

184 x 98 H82  
72.44" x 38.58" H32.28"  
DER.

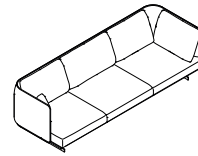

**SERSRI283BSPSBA**

283 x 98 H82  
111.42" x 38.58" H32.28"  
IZQ.

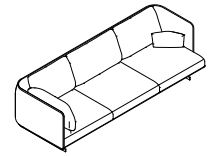

**SERSRD283BSPSBA**

283 x 98 H82  
111.42" x 38.58" H32.28"  
DER.

| MEASUREMENT. MESURE. MEDIDA.            | REF.                              | M.L. | COM / COL | 1        | 2        | 3        | 4        | 5        | L1       | L2       |
|---|-----------------------------------|------|-----------|----------|----------|----------|----------|----------|----------|----------|
| 184 x 98 H82   72.44" x 38.58" H32.28"  | SERRI184BSPS - SERRD184BSPS       | 11   | 2.727,27  | 2.805,79 | 2.954,55 | 3.115,70 | 3.413,22 | 3.929,75 | 4.041,32 | 4.628,10 |
| 283 x 98 H82   111.42" x 38.58" H32.28" | SERSRI283BSPSBA - SERSRD283BSPSBA | 16   | 3.971,07  | 4.111,57 | 4.330,58 | 4.570,25 | 5.016,53 | 5.847,11 | 6.033,06 | 6.855,37 |

SERENE. Ottomans. Poufs. Ottomans.

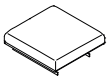

**SERP90BSPS**

90 x 94 H42  
35.43" x 37.01" H16.54"

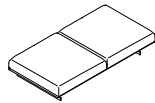

**SERP180BSPS**

180 x 94 H42  
70.87" x 37.01" H16.54"

| MEASUREMENT. MESURE. MEDIDA.           | REF.        | M.L. | COM / COL | 1        | 2        | 3        | 4        | 5        | L1       | L2       |
|--|-------------|------|-----------|----------|----------|----------|----------|----------|----------|----------|
| 90 x 94 H42   35.43" x 37.01" H16.54"  | SERP90BSPS  | 3    | 1.004,13  | 1.020,66 | 1.074,38 | 1.107,44 | 1.177,69 | 1.318,18 | 1.355,37 | 1.491,74 |
| 180 x 94 H42   70.87" x 37.01" H16.54" | SERP180BSPS | 5    | 1.677,69  | 1.731,40 | 1.780,99 | 1.851,24 | 2.000,00 | 2.239,67 | 2.289,26 | 2.528,93 |

SERENE. Chaise longues.

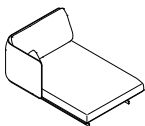

**SERCLI108BSPSBA**

108 x 160 H82  
42.52" x 62.99" H32.28"  
IZQ.

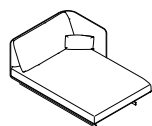

**SERCLD108BSPSBA**

108 x 160 H82  
42.52" x 62.99" H32.28"  
DER.

| MEASUREMENT. MESURE. MEDIDA.            | REF.                              | M.L. | COM / COL | 1        | 2        | 3        | 4        | 5        | L1       | L2       |
|---|-----------------------------------|------|-----------|----------|----------|----------|----------|----------|----------|----------|
| 108 x 160 H82   42.52" x 62.99" H32.28" | SERCLI108BSPSBA - SERCLD108BSPSBA | 7.5  | 2.351,24  | 2.429,75 | 2.528,93 | 2.623,97 | 2.826,45 | 3.177,69 | 3.264,46 | 3.615,70 |

# SERENE.

# SOFA. CANAPÉ. SOFÁ.



Designer  
Mario Ruiz

STYLE. ESTILO.  
Singular

VERSION. VERSIÓN.  
Suspended base. Base suspendue. Base suspendida.

VARIANTS. VARIANTES.  
Standard depth. Profondeur standard. Profundidad estándar. (98 cm - 38.58 in)  
Low arm. Accoudoir bas. Brazo bajo.

## FEATURES. TRAITS. CARACTERÍSTICAS.

**The high backrest costs an extra 47 euros per unit. Le dossier haut coûte 47 euros de plus par unité. El respaldo alto tiene un coste extra de 47 euros por unidad.**

Removable upholstery in seat, back and auxiliary cushions.

Wooden frame covered with flexible cold shaped polyurethane foam and polyester fibre.

Suspension consisting of fibreglass reinforced plastic slats.

Seat cushions in different polyurethane foam densities, with surface padding in fibre. Back cushions stuffed with polyester fibre and washed, sterilised down. Auxiliary cushions stuffed with polyester fibre and washed, sterilised down.

Metal bases coated in polyester powder paint with a manganese topcoat and LDPE stops.

Two back cushion heights available: Standard (82 cm - 32.28 in) or High (92 cm - 36.22)

Tapiserie déhoussable sur les coussins de l'assise, coussins du dossier et coussins auxiliaires.

Cadre en bois recouvert de mousse de polyuréthane souple à froid et de fibre de polyester.

Suspension au moyen de lattes renforcées avec de la fibre de verre.

Coussins de l'assise réalisés dans différentes densités de mousse polyuréthane, matelassés en surface avec du fibre. Coussins du dossier garnis de fibre de polyester et plumes lavées et stérilisées. Coussins auxiliaires garnis de fibre de polyester et plumes lavées et stérilisées.

Bases métalliques recouverts en peinture polyester en poudre finition manganèse avec butées en PEBD.

Deux hauteurs de coussin pour les dossiers disponibles : Standard (82 cm) ou Haut (92 cm)

Tapicería desenfundable en cojines de asiento, cojines de respaldo y cojines auxiliares.

Bastidor de madera recubierto de espuma de poliuretano flexible en frío y fibra de poliéster.

Suspensión mediante lamas de plástico reforzadas con fibra de vidrio.

Cojines de asiento realizados en distintas densidades de espuma de poliuretano, acolchado en la superficie con fibra. Cojines de respaldo rellenos de fibra de poliéster y pluma lavada y esterilizada. Cojines auxiliares rellenos de fibra de poliéster y pluma lavada y esterilizada.

Bases metálicas recubiertas en pintura poliéster en polvo acabado manganeso con topes de LDPE.

Dos alturas de respaldo disponibles: Estándar (82 cm) o Alto (92 cm)

## SERENE.

### GENERAL MEASUREMENTS. MESURES GÉNÉRALES. MEDIDAS GENERALES.

---

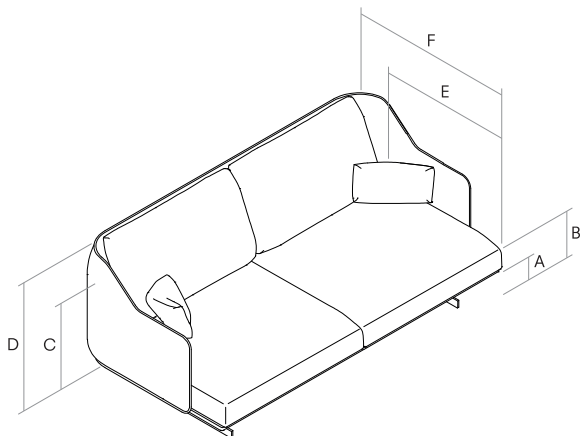

- A. Base height. Hauteur de base. Altura de base. 13 cm - 5.12"
- B. Seat height. Hauteur du siège. Altura de asiento. 42 cm - 16.54"
- C. Arm height. Hauteur du bras. Altura de brazo. 56 cm - 22.05"
- D. Backrest height. Hauteur du dossier. Altura de respaldo. 82 cm - 32.28"
- E. Seat depth. Profondeur d'assise. Profundidad de sentada. 58 cm - 22.83"
- F. Depth. Profondeur. Profundidad. 98 cm - 38.58"

### FINISHES. TRAITS. ACABADOS.

---

Finishes for the metal bases. Finitions des pieds métalliques. Acabados de las patas metálicas.

---

Polyester powder paint. Peinture polyester en poudre. Pintura poliéster en polvo.

---



Manganese metal.  
Métal manganèse.  
Metal manganeso.

### OPTIONAL BACK CUSHIONS. COUSSINS DU DOSSIER EN OPTION. COJINES DE RESPALDO OPCIONALES.

---

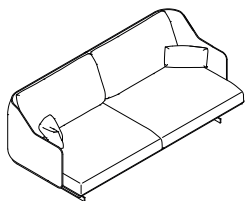

Standard option. Option standard. Opción estándar.  
Backrest height. Hauteur du dossier. Altura de respaldo.  
**82 cm - 32.28"**

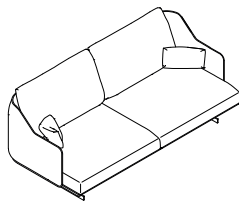

Premium option. Option premium. Opción premium.  
Backrest height. Hauteur du dossier. Altura de respaldo.  
**92 cm - 36.22"**

## SERENE.

### FINISHES. TRAITS. ACABADOS.

Wood finishes. Finitions bois. Acabado de la madera.



**RN**  
Natural oak.  
Chêne naturel.  
Roble natural.



**NA**  
Natural american walnut.  
Noyer américain.  
Nogal americano.



**RT**  
Dark stained oak.  
Chêne teint foncée.  
Roble teñido oscuro.



**RL**  
Oak painted in black with open-pore finish.  
Chêne laqué noir à pores ouverts.  
Roble lacado negro por abierto.

Lacquered. Laqué. Lacados.



SEDA



ALOE



KHAKI



BRICK











RUBI



KOKOA

## CONFIGURATOR.

Compatibility between furniture and upholstered elements. Compatibilité entre les meubles et les éléments tapissés. Compatibilidad entre mobiliario y elementos tapizados.

|  | REFERENCE.      | Supported references. Références compatibles. Referencias compatibles. |                                   |              |
|--|-----------------|--|-----------------------------------|--------------|
|  | <b>SERMU149</b> | SERS170BSPSBB  | SERSI165BSPSBB - SERSD165BSPSBB   | SERS0160BSPS |
|  | <b>SERMU169</b> | SERS190BSPSBB  | SERSI185BSPSBB - SERSD185BSPSBB   | SERS0180BSPS |
|  | <b>SERMU189</b> | SERS210BSPSBB  |                                   |              |
|  | <b>SERMU209</b> | SERS230BSPSBB  |                                   |              |
|  | <b>SERMU229</b> | SERS250BSPSBB  | SERSI245BSPSBB - SERSD245BSPSBB   | SERS0240BSPS |
|  | <b>SERMU162</b> | SERRI174BSPS - SERRD174BSPS  | SERSRI263BSPSBB - SERSRD263BSPSBB |              |
|  | <b>SERMU172</b> | SERRI184BSPS - SERRD184BSPS  | SERSRI283BSPSBB - SERSRD283BSPSBB |              |
|  | <b>SERMU83</b>  | SERCLI98BSPSBB - SERCLD98BSPSBB  |                                   |              |
|  | <b>SERMU93</b>  | SERCLI108BSPSBB - SERCLD108BSPSBB                                      |                                   |              |

## SERENE.

### PRICES. PRIX. PRECIOS.

SERENE. Sofa. Canapé. Sofá.



**SERS170BSPSBB**

170 x 98 H82  
66.93" x 38.58" H32.28"

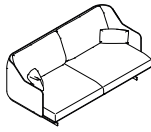

**SERS190BSPSBB**

190 x 98 H82  
74.80" x 38.58" H32.28"

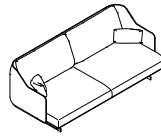

**SERS210BSPSBB**

210 x 98 H82  
82.68" x 38.58" H32.28"

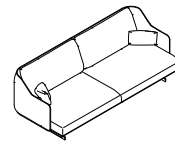

**SERS230BSPSBB**

230 x 98 H82  
90.55" x 38.58" H32.28"

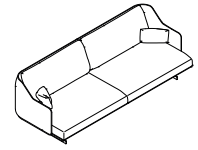

**SERS250BSPSBB**

250 x 98 H82  
98.43" x 38.58" H32.28"

| MEASUREMENT. MESURE. MEDIDA.           | REF.          | M.L. | COM / COL | 1        | 2        | 3        | 4        | 5        | L1       | L2       |
|--|---------------|------|-----------|----------|----------|----------|----------|----------|----------|----------|
| 170 x 98 H82   66.93" x 38.58" H32.28" | SERS170BSPSBB | 11.5 | 2.607,44  | 2.702,48 | 2.842,98 | 3.008,26 | 3.305,79 | 3.867,77 | 3.991,74 | 4.541,32 |
| 190 x 98 H82   74.80" x 38.58" H32.28" | SERS190BSPSBB | 11.5 | 2.739,67  | 2.826,45 | 2.975,21 | 3.132,23 | 3.438,02 | 3.983,47 | 4.111,57 | 4.665,29 |
| 210 x 98 H82   82.68" x 38.58" H32.28" | SERS210BSPSBB | 12   | 2.842,98  | 2.938,02 | 3.086,78 | 3.243,80 | 3.533,06 | 4.086,78 | 4.210,74 | 4.743,80 |
| 230 x 98 H82   90.55" x 38.58" H32.28" | SERS230BSPSBB | 12   | 3.140,50  | 3.235,54 | 3.392,56 | 3.533,06 | 3.851,24 | 4.400,83 | 4.533,06 | 5.086,78 |
| 250 x 98 H82   98.43" x 38.58" H32.28" | SERS250BSPSBB | 12.5 | 3.413,22  | 3.508,26 | 3.665,29 | 3.830,58 | 4.157,02 | 4.743,80 | 4.867,77 | 5.462,81 |

SERENE. Tables for sofas with 1 arm, without arms and corners. Tables pour canapés avec 1 accoudoir, sans accoudoirs et angles. Mesas para sofás con un brazo, sin brazos y rincones.



**SERME38**

38 x 92 H16  
14.96" x 36.22" H6.30"



**SERME94**

94 x 89 H16  
37.01" x 35.04" H6.30"

| MEASUREMENT. MESURE. MEDIDA.         | FINISHES. TRAITS. ACABADOS.   | REF.      | PRICE. PRIX. PRECIO. |
|--------------------------------------|---|-----------|----------------------|
| 38 x 92 H16   14.96" x 36.22" H6.30" | Natural oak. Chêne naturel. Roble natural.  | SERME38RN | 756,20               |
| 38 x 92 H16   14.96" x 36.22" H6.30" | American walnut. Noyer américain. Nogal americano.  | SERME38NA | 814,05               |
| 38 x 92 H16   14.96" x 36.22" H6.30" | Dark stained oak. Chêne teinté foncé. Roble teñido oscuro.  | SERME38RT | 756,20               |
| 38 x 92 H16   14.96" x 36.22" H6.30" | Oak painted in black with open-pore finish. Chêne laqué noir à pores ouverts. Roble lacado negro por abierto. | SERME38RL | 814,05               |
| 38 x 92 H16   14.96" x 36.22" H6.30" | Matt lacquer. Laque mate. Lacado mate.  | SERME38LA | 756,20               |
| 94 x 89 H16   37.01" x 35.04" H6.30" | Natural oak. Chêne naturel. Roble natural.  | SERME94RN | 888,43               |
| 94 x 89 H16   37.01" x 35.04" H6.30" | American walnut. Noyer américain. Nogal americano.  | SERME94NA | 962,81               |
| 94 x 89 H16   37.01" x 35.04" H6.30" | Dark stained oak. Chêne teinté foncé. Roble teñido oscuro.  | SERME94RT | 888,43               |
| 94 x 89 H16   37.01" x 35.04" H6.30" | Oak painted in black with open-pore finish. Chêne laqué noir à pores ouverts. Roble lacado negro por abierto. | SERME94RL | 962,81               |
| 94 x 89 H16   37.01" x 35.04" H6.30" | Matt lacquer. Laque mate. Lacado mate.  | SERME94LA | 888,43               |

## SERENE.

### PRICES. PRIX. PRECIOS.

SERENE. Furniture for sofas, sofas with 1 arm, and without arms. Meubles pour canapés, canapés avec 1 accoudoir et sans accoudoirs. Muebles para sofás, para sofás con 1 brazo y para sofás sin brazos.



**SERMU149**

149 x 25 H43

63.78" x 9.84" H16.93"



**SERMU169**

169 x 25 H43

66.54" x 9.84" H16.93"

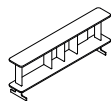

**SERMU189**

189 x 25 H43

74.41" x 9.84" H16.93"

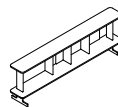

**SERMU209**

209 x 25 H43

82.28" x 9.84" H16.93"

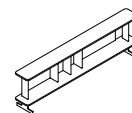

**SERMU229**

229 x 25 H43

90.16" x 9.84" H16.93"

| MEASUREMENT. MESURE. MEDIDA.          | FINISHES. TRAITS. ACABADOS.   | REF.       | PRICE. PRIX. PRECIO. |
|---------------------------------------|---|------------|----------------------|
| 149 x 25 H43   63.78" x 9.84" H16.93" | Natural oak. Chêne naturel. Roble natural.  | SERMU149RN | 1.161,16             |
| 149 x 25 H43   63.78" x 9.84" H16.93" | American walnut. Noyer américain. Nogal americano.  | SERMU149NA | 1.256,20             |
| 149 x 25 H43   63.78" x 9.84" H16.93" | Dark stained oak. Chêne teinté foncé. Roble teñido oscuro.  | SERMU149RT | 1.161,16             |
| 149 x 25 H43   63.78" x 9.84" H16.93" | Oak painted in black with open-pore finish. Chêne laqué noir à pores ouverts. Roble lacado negro por abierto. | SERMU149RL | 1.256,20             |
| 149 x 25 H43   63.78" x 9.84" H16.93" | Matt lacquer. Laque mate. Lacado mate.  | SERMU149LA | 1.161,16             |
| 169 x 25 H43   66.54" x 9.84" H16.93" | Natural oak. Chêne naturel. Roble natural.  | SERMU169RN | 1.235,54             |
| 169 x 25 H43   66.54" x 9.84" H16.93" | American walnut. Noyer américain. Nogal americano.  | SERMU169NA | 1.342,98             |
| 169 x 25 H43   66.54" x 9.84" H16.93" | Dark stained oak. Chêne teinté foncé. Roble teñido oscuro.  | SERMU169RT | 1.235,54             |
| 169 x 25 H43   66.54" x 9.84" H16.93" | Oak painted in black with open-pore finish. Chêne laqué noir à pores ouverts. Roble lacado negro por abierto. | SERMU169RL | 1.342,98             |
| 169 x 25 H43   66.54" x 9.84" H16.93" | Matt lacquer. Laque mate. Lacado mate.  | SERMU169LA | 1.235,54             |
| 189 x 25 H43   74.41" x 9.84" H16.93" | Natural oak. Chêne naturel. Roble natural.  | SERMU189RN | 1.355,37             |
| 189 x 25 H43   74.41" x 9.84" H16.93" | American walnut. Noyer américain. Nogal americano.  | SERMU189NA | 1.442,15             |
| 189 x 25 H43   74.41" x 9.84" H16.93" | Dark stained oak. Chêne teinté foncé. Roble teñido oscuro.  | SERMU189RT | 1.322,31             |
| 189 x 25 H43   74.41" x 9.84" H16.93" | Oak painted in black with open-pore finish. Chêne laqué noir à pores ouverts. Roble lacado negro por abierto. | SERMU189RL | 1.442,15             |
| 189 x 25 H43   74.41" x 9.84" H16.93" | Matt lacquer. Laque mate. Lacado mate.  | SERMU189LA | 1.322,31             |
| 209 x 25 H43   82.28" x 9.84" H16.93" | Natural oak. Chêne naturel. Roble natural.  | SERMU209RN | 1.396,69             |
| 209 x 25 H43   82.28" x 9.84" H16.93" | American walnut. Noyer américain. Nogal americano.  | SERMU209NA | 1.495,87             |
| 209 x 25 H43   82.28" x 9.84" H16.93" | Dark stained oak. Chêne teinté foncé. Roble teñido oscuro.  | SERMU209RT | 1.396,69             |
| 209 x 25 H43   82.28" x 9.84" H16.93" | Oak painted in black with open-pore finish. Chêne laqué noir à pores ouverts. Roble lacado negro por abierto. | SERMU209RL | 1.495,87             |
| 209 x 25 H43   82.28" x 9.84" H16.93" | Matt lacquer. Laque mate. Lacado mate.  | SERMU209LA | 1.396,69             |
| 229 x 25 H43   90.16" x 9.84" H16.93" | Natural oak. Chêne naturel. Roble natural.  | SERMU229RN | 1.508,26             |
| 229 x 25 H43   90.16" x 9.84" H16.93" | American walnut. Noyer américain. Nogal americano.  | SERMU229NA | 1.603,31             |
| 229 x 25 H43   90.16" x 9.84" H16.93" | Dark stained oak. Chêne teinté foncé. Roble teñido oscuro.  | SERMU229RT | 1.508,26             |
| 229 x 25 H43   90.16" x 9.84" H16.93" | Oak painted in black with open-pore finish. Chêne laqué noir à pores ouverts. Roble lacado negro por abierto. | SERMU229RL | 1.603,31             |
| 229 x 25 H43   90.16" x 9.84" H16.93" | Matt lacquer. Laque mate. Lacado mate.  | SERMU229LA | 1.508,26             |

## SERENE.

### PRICES. PRIX. PRECIOS.

SERENE. Furniture for chaise longue. Meubles pour chaise longue. Muebles para chaise longue.



#### SERMU83

83 x 25 H43  
32.68" x 9.84" H16.93"



#### SERMU93

93 x 25 H43  
36.61" x 9.84" H16.93"

| MEASUREMENT. MESURE. MEDIDA.         | FINISHES. TRAITS. ACABADOS.   | REF.      | PRICE. PRIX. PRECIO. |
|--------------------------------------|---|-----------|----------------------|
| 83 x 25 H43   32.68" x 9.84" H16.93" | Natural oak. Chêne naturel. Roble natural.  | SERMU83RN | 954,55               |
| 83 x 25 H43   32.68" x 9.84" H16.93" | American walnut. Noyer américain. Nogal americano.  | SERMU83NA | 1.020,66             |
| 83 x 25 H43   32.68" x 9.84" H16.93" | Dark stained oak. Chêne teinté foncé. Roble teñido oscuro.  | SERMU83RT | 954,55               |
| 83 x 25 H43   32.68" x 9.84" H16.93" | Oak painted in black with open-pore finish. Chêne laqué noir à pores ouverts. Roble lacado negro por abierto. | SERMU83RL | 1.020,66             |
| 83 x 25 H43   32.68" x 9.84" H16.93" | Matt lacquer. Laque mate. Lacado mate.  | SERMU83LA | 954,55               |
| 93 x 25 H43   36.61" x 9.84" H16.93" | Natural oak. Chêne naturel. Roble natural.  | SERMU93RN | 987,60               |
| 93 x 25 H43   36.61" x 9.84" H16.93" | American walnut. Noyer américain. Nogal americano.  | SERMU93NA | 1.041,32             |
| 93 x 25 H43   36.61" x 9.84" H16.93" | Dark stained oak. Chêne teinté foncé. Roble teñido oscuro.  | SERMU93RT | 987,60               |
| 93 x 25 H43   36.61" x 9.84" H16.93" | Oak painted in black with open-pore finish. Chêne laqué noir à pores ouverts. Roble lacado negro por abierto. | SERMU93RL | 1.041,32             |
| 93 x 25 H43   36.61" x 9.84" H16.93" | Matt lacquer. Laque mate. Lacado mate.  | SERMU93LA | 987,60               |

SERENE. Furniture for corner and sofa corner. Meubles pour angle et canapé angle. Muebles para rincón y sofá rincón.



#### SERMU162

162 x 25 H43  
63.78" x 9.84" H16.93"

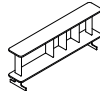

#### SERMU172

172 x 25 H43  
67.72" x 9.84" H16.93"

| MEASUREMENT. MESURE. MEDIDA.          | FINISHES. TRAITS. ACABADOS.   | REF.       | PRICE. PRIX. PRECIO. |
|---------------------------------------|---|------------|----------------------|
| 162 x 25 H43   63.78" x 9.84" H16.93" | Natural oak. Chêne naturel. Roble natural.  | SERMU162RN | 1.214,88             |
| 162 x 25 H43   63.78" x 9.84" H16.93" | American walnut. Noyer américain. Nogal americano.  | SERMU162NA | 1.314,05             |
| 162 x 25 H43   63.78" x 9.84" H16.93" | Dark stained oak. Chêne teinté foncé. Roble teñido oscuro.  | SERMU162RT | 1.214,88             |
| 162 x 25 H43   63.78" x 9.84" H16.93" | Oak painted in black with open-pore finish. Chêne laqué noir à pores ouverts. Roble lacado negro por abierto. | SERMU162RL | 1.314,05             |
| 162 x 25 H43   63.78" x 9.84" H16.93" | Matt lacquer. Laque mate. Lacado mate.  | SERMU162LA | 1.214,88             |
| 172 x 25 H43   67.72" x 9.84" H16.93" | Natural oak. Chêne naturel. Roble natural.  | SERMU172RN | 1.293,39             |
| 172 x 25 H43   67.72" x 9.84" H16.93" | American walnut. Noyer américain. Nogal americano.  | SERMU172NA | 1.421,49             |
| 172 x 25 H43   67.72" x 9.84" H16.93" | Dark stained oak. Chêne teinté foncé. Roble teñido oscuro.  | SERMU172RT | 1.293,39             |
| 172 x 25 H43   67.72" x 9.84" H16.93" | Oak painted in black with open-pore finish. Chêne laqué noir à pores ouverts. Roble lacado negro por abierto. | SERMU172RL | 1.421,49             |
| 172 x 25 H43   67.72" x 9.84" H16.93" | Matt lacquer. Laque mate. Lacado mate.  | SERMU172LA | 1.293,39             |

## SERENE.

PRICES. PRIX. PRECIOS.

SEAT CUSHION 80 CM. COUSSIN DE L'ASSISE DE 80 CM. COJÍN DE ASIENTO DE 80 CM.

SERENE. Sofas with 1 arm. Canapés avec 1 accoudoir. Sofás con 1 brazo.

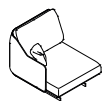

**SERSI85BSPSBB**

85 x 98 H82  
33.46" x 38.58" H32.28"  
IZQ.

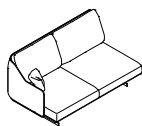

**SERSI165BSPSBB**

165 x 98 H82  
64.96" x 38.58" H32.28"  
IZQ.

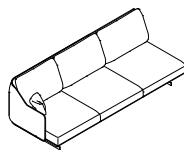

**SERSI245BSPSBB**

245 x 98 H82  
96.46" x 38.58" H32.28"  
IZQ.



**SERSD85BSPSBB**

85 x 98 H82  
33.46" x 38.58" H32.28"  
DER.

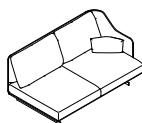

**SERSD165BSPSBB**

165 x 98 H82  
64.96" x 38.58" H32.28"  
DER.

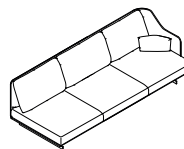

**SERSD245BSPSBB**

245 x 98 H82  
96.46" x 38.58" H32.28"  
DER.

| MEASUREMENT. MESURE. MEDIDA.           | REF.                            | M.L. | COM / COL | 1        | 2        | 3        | 4        | 5        | L1       | L2       |
|--|---------------------------------|------|-----------|----------|----------|----------|----------|----------|----------|----------|
| 85 x 98 H82   33.46" x 38.58" H32.28"  | SERSI85BSPSBB - SERSD85BSPSBB   | 7    | 1.607,44  | 1.652,89 | 1.731,40 | 1.801,65 | 1.966,94 | 2.239,67 | 2.309,92 | 2.578,51 |
| 165 x 98 H82   64.96" x 38.58" H32.28" | SERSI165BSPSBB - SERSD165BSPSBB | 10   | 2.413,22  | 2.491,74 | 2.623,97 | 2.772,73 | 3.037,19 | 3.524,79 | 3.640,50 | 4.132,23 |
| 245 x 98 H82   96.46" x 38.58" H32.28" | SERSI245BSPSBB - SERSD245BSPSBB | 15   | 3.351,24  | 3.475,21 | 3.657,02 | 3.859,50 | 4.252,07 | 4.954,55 | 5.111,57 | 5.814,05 |

SERENE. Sofas without arms. Canapés sans accoudoirs. Sofás sin brazos.

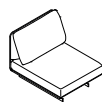

**SERS080BSPS**

80 x 98 H82  
31.50" x 38.58" H32.28"

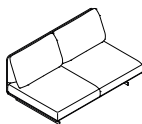

**SERS0160BSPS**

160 x 98 H82  
62.99" x 38.58" H32.28"

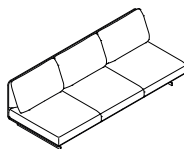

**SERS0240BSPS**

240 x 98 H82  
94.49" x 38.58" H32.28"

| MEASUREMENT. MESURE. MEDIDA.           | REF.         | M.L. | COM / COL | 1        | 2        | 3        | 4        | 5        | L1       | L2       |
|--|--------------|------|-----------|----------|----------|----------|----------|----------|----------|----------|
| 80 x 98 H82   31.50" x 38.58" H32.28"  | SERS080BSPS  | 6    | 1.458,68  | 1.491,74 | 1.553,72 | 1.623,97 | 1.739,67 | 1.958,68 | 2.000,00 | 2.231,40 |
| 160 x 98 H82   62.99" x 38.58" H32.28" | SERS0160BSPS | 9.5  | 2.247,93  | 2.309,92 | 2.438,02 | 2.561,98 | 2.789,26 | 3.235,54 | 3.305,79 | 3.743,80 |
| 240 x 98 H82   94.49" x 38.58" H32.28" | SERS0240BSPS | 14.5 | 3.140,50  | 3.256,20 | 3.421,49 | 3.603,31 | 3.962,81 | 4.595,04 | 4.743,80 | 5.376,03 |



SERENE.

PRICES. PRIX. PRECIOS.

SEAT CUSHION 80 CM. COUSSIN DE L'ASSISE DE 80 CM. COJÍN DE ASIENTO DE 80 CM.

SERENE. Corner and sofa corner. Angle et canapé angle. Rincón y sofá rincón.

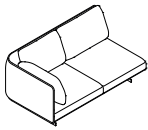

**SERRI174BSPS**

174 x 98 H82  
68.50" x 38.58" H32.28"  
IZQ.

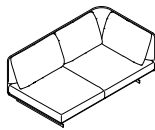

**SERRD174BSPS**

174 x 98 H82  
68.50" x 38.58" H32.28"  
DER.

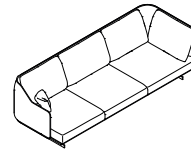

**SERSRI263BSPSBB**

263 x 98 H82  
103.54" x 38.58" H32.28"  
IZQ.

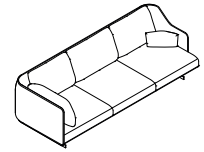

**SERSRD263BSPSBB**

263 x 98 H82  
103.54" x 38.58" H32.28"  
DER.

| MEASUREMENT. MESURE. MEDIDA.            | REF.                              | M.L. | COM / COL | 1        | 2        | 3        | 4        | 5        | L1       | L2       |
|---|-----------------------------------|------|-----------|----------|----------|----------|----------|----------|----------|----------|
| 174 x 98 H82   68.50" x 38.58" H32.28"  | SERRI174BSPS - SERRD174BSPS       | 11   | 2.685,95  | 2.772,73 | 2.913,22 | 3.070,25 | 3.367,77 | 3.913,22 | 4.024,79 | 4.578,51 |
| 263 x 98 H82   103.54" x 38.58" H32.28" | SERSRI263BSPSBB - SERSRD263BSPSBB | 15.5 | 3.657,02  | 3.789,26 | 4.008,26 | 4.252,07 | 4.698,35 | 5.516,53 | 5.690,08 | 6.512,40 |

SERENE. Ottomans. Poufs. Ottomans.



**SERP80BSPS**

80 x 94 H42  
31.50" x 37.01" H16.54"

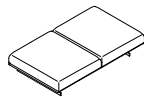

**SERP160BSPS**

160 x 94 H42  
62.99" x 37.01" H16.54"

| MEASUREMENT. MESURE. MEDIDA.           | REF.        | M.L. | COM / COL | 1        | 2        | 3        | 4        | 5        | L1       | L2       |
|--|-------------|------|-----------|----------|----------|----------|----------|----------|----------|----------|
| 80 x 94 H42   31.50" x 37.01" H16.54"  | SERP80BSPS  | 2.5  | 950,41    | 983,47   | 1.004,13 | 1.053,72 | 1.123,97 | 1.247,93 | 1.272,73 | 1.404,96 |
| 160 x 94 H42   62.99" x 37.01" H16.54" | SERP160BSPS | 4.5  | 1.590,91  | 1.607,44 | 1.661,16 | 1.731,40 | 1.834,71 | 2.020,66 | 2.090,91 | 2.272,73 |

SERENE. Chaise longues.

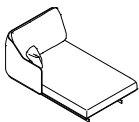

**SERCLI98BSPSBB**

98 x 160 H82  
38.58" x 62.99" H32.28"  
IZQ.



**SERCLD98BSPSBB**

98 x 160 H82  
38.58" x 62.99" H32.28"  
DER.

| MEASUREMENT. MESURE. MEDIDA.           | REF.                            | M.L. | COM / COL | 1        | 2        | 3        | 4        | 5        | L1       | L2       |
|--|---------------------------------|------|-----------|----------|----------|----------|----------|----------|----------|----------|
| 98 x 160 H82   38.58" x 62.99" H32.28" | SERCLI98BSPSBB - SERCLD98BSPSBB | 7.5  | 2.309,92  | 2.351,24 | 2.458,68 | 2.561,98 | 2.764,46 | 3.132,23 | 3.194,21 | 3.561,98 |

SERENE.

PRICES. PRIX. PRECIOS.

SEAT CUSHION 90 CM. COUSSIN DE L'ASSISE DE 90 CM. COJÍN DE ASIENTO DE 90 CM.

SERENE. Sofas with 1 arm. Canapés avec 1 accoudoir. Sofás con 1 brazo.



**SERSI95BSPSBB**

95 x 98 H82  
37.40" x 38.58" H32.28"  
IZQ.

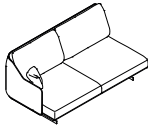

**SERSI185BSPSBB**

185 x 98 H82  
72.83" x 38.58" H32.28"  
IZQ.

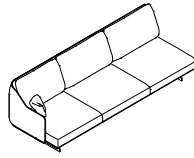

**SERSI275BSPSBB**

275 x 98 H82  
108.27" x 38.58" H32.28"  
IZQ.



**SERSD95BSPSBB**

95 x 98 H82  
37.40" x 38.58" H32.28"  
DER.



**SERSD185BSPSBB**

185 x 98 H82  
72.83" x 38.58" H32.28"  
DER.

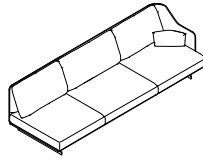

**SERSD275BSPSBB**

275 x 98 H82  
108.27" x 38.58" H32.28"  
DER.

| MEASUREMENT. MESURE. MEDIDA.            | REF.                            | M.L. | COM / COL | 1        | 2        | 3        | 4        | 5        | L1       | L2       |
|---|---------------------------------|------|-----------|----------|----------|----------|----------|----------|----------|----------|
| 95 x 98 H82   37.40" x 38.58" H32.28"   | SERSI95BSPSBB - SERSD95BSPSBB   | 8    | 1.694,21  | 1.739,67 | 1.801,65 | 1.896,69 | 2.061,98 | 2.334,71 | 2.404,96 | 2.685,95 |
| 185 x 98 H82   72.83" x 38.58" H32.28"  | SERSI185BSPSBB - SERSD185BSPSBB | 11   | 2.586,78  | 2.669,42 | 2.805,79 | 2.938,02 | 3.202,48 | 3.710,74 | 3.805,79 | 4.314,05 |
| 275 x 98 H82   108.27" x 38.58" H32.28" | SERSI275BSPSBB - SERSD275BSPSBB | 15.5 | 3.595,04  | 3.710,74 | 3.913,22 | 4.111,57 | 4.500,00 | 5.198,35 | 5.363,64 | 6.082,64 |

SERENE. Sofas without arms. Canapés sans accoudoirs. Sofás sin brazo.



**SERS090BSPS**

90 x 98 H82  
35.43" x 38.58" H32.28"

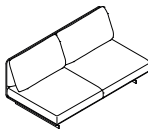

**SERS0180BSPS**

180 x 98 H82  
70.87" x 38.58" H32.28"

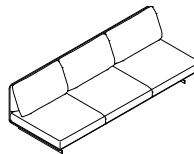

**SERS0270BSPS**

270 x 98 H82  
106.30" x 38.58" H32.28"

| MEASUREMENT. MESURE. MEDIDA.            | REF.         | M.L. | COM / COL | 1        | 2        | 3        | 4        | 5        | L1       | L2       |
|---|--------------|------|-----------|----------|----------|----------|----------|----------|----------|----------|
| 90 x 98 H82   35.43" x 38.58" H32.28"   | SERS090BSPS  | 7    | 1.537,19  | 1.590,91 | 1.652,89 | 1.702,48 | 1.842,98 | 2.090,91 | 2.123,97 | 2.359,50 |
| 180 x 98 H82   70.87" x 38.58" H32.28"  | SERS0180BSPS | 10.5 | 2.438,02  | 2.500,00 | 2.623,97 | 2.764,46 | 2.983,47 | 3.429,75 | 3.524,79 | 3.962,81 |
| 270 x 98 H82   106.30" x 38.58" H32.28" | SERS0270BSPS | 14.5 | 3.413,22  | 3.508,26 | 3.681,82 | 3.859,50 | 4.235,54 | 4.859,50 | 5.016,53 | 5.652,89 |

SERENE.

PRICES. PRIX. PRECIOS.

SEAT CUSHION 90 CM. COUSSIN DE L'ASSISE DE 90 CM. COJÍN DE ASIENTO DE 90 CM.

SERENE. Corner and sofa corner. Angle et canapé angle. Rincón y sofá rincón.

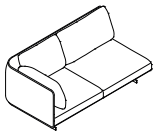

**SERRI184BSPS**

184 x 98 H82  
72.44" x 38.58" H32.28"  
IZQ.

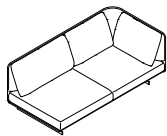

**SERRD184BSPS**

184 x 98 H82  
72.44" x 38.58" H32.28"  
DER.

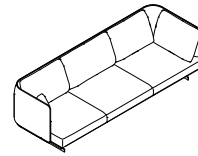

**SERSRI283BSPSBB**

283 x 98 H82  
111.42" x 38.58" H32.28"  
IZQ.

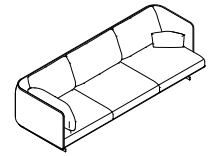

**SERSRD283BSPSBB**

283 x 98 H82  
111.42" x 38.58" H32.28"  
DER.

| MEASUREMENT. MESURE. MEDIDA.            | REF.                              | M.L. | COM / COL | 1        | 2        | 3        | 4        | 5        | L1       | L2       |
|---|-----------------------------------|------|-----------|----------|----------|----------|----------|----------|----------|----------|
| 184 x 98 H82   72.44" x 38.58" H32.28"  | SERRI184BSPS - SERRD184BSPS       | 11   | 2.727,27  | 2.805,79 | 2.954,55 | 3.115,70 | 3.413,22 | 3.929,75 | 4.041,32 | 4.628,10 |
| 283 x 98 H82   111.42" x 38.58" H32.28" | SERSRI283BSPSBA - SERSRD283BSPSBA | 16   | 3.971,07  | 4.111,57 | 4.330,58 | 4.570,25 | 5.016,53 | 5.847,11 | 6.033,06 | 6.855,37 |

SERENE. Ottomans. Poufs. Ottomans.

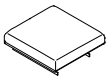

**SERP90BSPS**

90 x 94 H42  
35.43" x 37.01" H16.54"

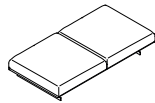

**SERP180BSPS**

180 x 94 H42  
70.87" x 37.01" H16.54"

| MEASUREMENT. MESURE. MEDIDA.           | REF.        | M.L. | COM / COL | 1        | 2        | 3        | 4        | 5        | L1       | L2       |
|--|-------------|------|-----------|----------|----------|----------|----------|----------|----------|----------|
| 90 x 94 H42   35.43" x 37.01" H16.54"  | SERP90BSPS  | 3    | 1.004,13  | 1.020,66 | 1.074,38 | 1.107,44 | 1.177,69 | 1.318,18 | 1.355,37 | 1.491,74 |
| 180 x 94 H42   70.87" x 37.01" H16.54" | SERP180BSPS | 5    | 1.677,69  | 1.731,40 | 1.780,99 | 1.851,24 | 2.000,00 | 2.239,67 | 2.289,26 | 2.528,93 |

SERENE. Chaise longues.

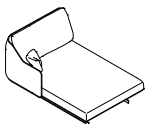

**SERCLI108BSPSBB**

108 x 160 H82  
42.52" x 62.99" H32.28"  
IZQ.

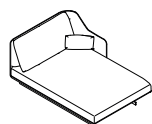

**SERCLD108BSPSBB**

108 x 160 H82  
42.52" x 62.99" H32.28"  
DER.

| MEASUREMENT. MESURE. MEDIDA.            | REF.                              | M.L. | COM / COL | 1        | 2        | 3        | 4        | 5        | L1       | L2       |
|---|-----------------------------------|------|-----------|----------|----------|----------|----------|----------|----------|----------|
| 108 x 160 H82   42.52" x 62.99" H32.28" | SERCLI108BSPSBA - SERCLD108BSPSBA | 7.5  | 2.351,24  | 2.429,75 | 2.528,93 | 2.623,97 | 2.826,45 | 3.177,69 | 3.264,46 | 3.615,70 |

# SERENE.

# SOFA. CANAPÉ. SOFÁ.



Designer  
Mario Ruiz

STYLE. ESTILO.  
Singular

VERSION. VERSIÓN.  
Suspended base. Base suspendue. Base suspendida.

VARIANTS. VARIANTES.  
Deluxe depth. Profondeur deluxe. Profundidad deluxe. (108 cm - 42.52 in)  
High arm. Accoudoir haut. Brazo alto.

## FEATURES. TRAITS. CARACTERÍSTICAS.

**The high backrest costs an extra 47 euros per unit. Le dossier haut coûte 47 euros de plus par unité. El respaldo alto tiene un coste extra de 47 euros por unidad.**

Removable upholstery in seat, back and auxiliary cushions.

Wooden frame covered with flexible cold shaped polyurethane foam and polyester fibre.

Suspension consisting of fibreglass reinforced plastic slats.

Seat cushions in different polyurethane foam densities, with surface padding in fibre. Back cushions stuffed with polyester fibre and washed, sterilised down. Auxiliary cushions stuffed with polyester fibre and washed, sterilised down.

Metal bases coated in polyester powder paint with a manganese topcoat and LDPE stops.

Two back cushions heights available: Standard (82 cm - 32.28 in) or High (92 cm - 36.22)

Tapiserie déhoussable sur les coussins de l'assise, coussins du dossier et coussins auxiliaires.

Cadre en bois recouvert de mousse de polyuréthane souple à froid et de fibre de polyester.

Suspension au moyen de lattes renforcées avec de la fibre de verre.

Coussins de l'assise réalisés dans différentes densités de mousse polyuréthane, matelassés en surface avec du fibre. Coussins du dossier garnis de fibre de polyester et plumes lavées et stérilisées. Coussins auxiliaires garnis de fibre de polyester et plumes lavées et stérilisées.

Bases métalliques recouverts en peinture polyester en poudre finition manganèse avec butées en PEBD.

Deux hauteurs de coussin pour les dossiers disponibles : Standard (82 cm) ou Haut (92 cm)

Tapicería desenfundable en cojines de asiento, cojines de respaldo y cojines auxiliares.

Bastidor de madera recubierto de espuma de poliuretano flexible en frío y fibra de poliéster.

Suspensión mediante lamas de plástico reforzadas con fibra de vidrio.

Cojines de asiento realizados en distintas densidades de espuma de poliuretano, acolchado en la superficie con fibra. Cojines de respaldo rellenos de fibra de poliéster y pluma lavada y esterilizada. Cojines auxiliares rellenos de fibra de poliéster y pluma lavada y esterilizada.

Bases metálicas recubiertas en pintura poliéster en polvo acabado manganeso con topes de LDPE.

Dos alturas de respaldo disponibles: Estándar (82 cm) o Alto (92 cm)

## SERENE.

### GENERAL MEASUREMENTS. MESURES GÉNÉRALES. MEDIDAS GENERALES.

---

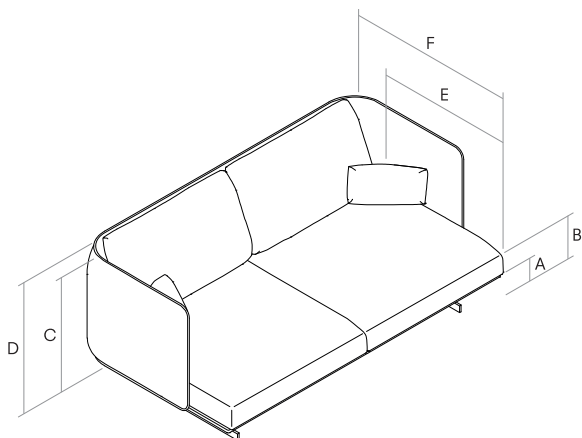

- A. Base height. Hauteur de base. Altura de base. 13 cm - 5.12"
- B. Seat height. Hauteur du siège. Altura de asiento. 42 cm - 16.54"
- C. Arm height. Hauteur du bras. Altura de brazo. 77 cm - 30.31"
- D. Backrest height. Hauteur du dossier. Altura de respaldo. 82 cm - 32.28"
- E. Seat depth. Profondeur d'assise. Profundidad de sentada. 68 cm - 26.77"
- F. Depth. Profondeur. Profundidad. 108 cm - 42.52"

### FINISHES. TRAITS. ACABADOS.

---

Finishes for the metal bases. Finitions des pieds métalliques. Acabados de las patas metálicas.

---

Polyester powder paint. Peinture polyester en poudre. Pintura poliéster en polvo.

---



Manganese metal.  
Métal manganèse.  
Metal manganeso.

### OPTIONAL BACK CUSHIONS. COUSSINS DU DOSSIER EN OPTION. COJINES DE RESPALDO OPCIONALES.

---

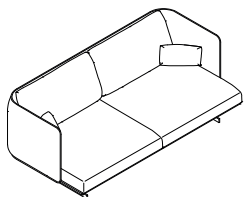

Standard option. Option standard. Opción estándar.  
Backrest height. Hauteur du dossier. Altura de respaldo.  
**82 cm - 32.28"**

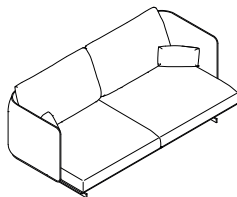

Premium option. Option premium. Opción premium.  
Backrest height. Hauteur du dossier. Altura de respaldo.  
**92 cm - 36.22"**

## SERENE.

### FINISHES. TRAITS. ACABADOS.

Wood finishes. Finitions bois. Acabado de la madera.



**RN**  
Natural oak.  
Chêne naturel.  
Roble natural.



**NA**  
Natural american walnut.  
Noyer américain.  
Nogal americano.



**RT**  
Dark stained oak.  
Chêne teint foncée.  
Roble teñido oscuro.



**RL**  
Oak painted in black with open-pore finish.  
Chêne laqué noir à pores ouverts.  
Roble lacado negro por abierto.

Lacquered. Laqué. Lacados.



SEDA



ALOE



KHAKI



BRICK











RUBI



KOKOA

## CONFIGURATOR.

Compatibility between furniture and upholstered elements. Compatibilité entre les meubles et les éléments tapissés. Compatibilidad entre mobiliario y elementos tapizados.

|  | REFERENCE.      | Supported references. Références compatibles. Referencias compatibles. |                                   |              |
|--|-----------------|--|-----------------------------------|--------------|
|  | <b>SERMU149</b> | SERS170BSPDBA  | SERSI165BSPDBA - SERSD165BSPDBA   | SERS0160BSPD |
|  | <b>SERMU169</b> | SERS190BSPDBA  | SERSI185BSPDBA - SERSD185BSPDBA   | SERS0180BSPD |
|  | <b>SERMU189</b> | SERS210BSPDBA  |                                   |              |
|  | <b>SERMU209</b> | SERS230BSPDBA  |                                   |              |
|  | <b>SERMU229</b> | SERS250BSPDBA  | SERSI245BSPDBA - SERSD245BSPDBA   | SERS0240BSPD |
|  | <b>SERMU162</b> | SERRI174BSPD - SERRD174BSPD  | SERSRI263BSPDBA - SERSRD263BSPDBA |              |
|  | <b>SERMU172</b> | SERRI184BSPD - SERRD184BSPD  | SERSRI283BSPDBA - SERSRD283BSPDBA |              |
|  | <b>SERMU83</b>  | SERCLI98BSPDBA - SERCLD98BSPDBA  |                                   |              |
|  | <b>SERMU93</b>  | SERCLI108BSPDBA - SERCLD108BSPDBA                                      |                                   |              |

## SERENE.

PRICES. PRIX. PRECIOS.

SERENE. Sofa. Canapé. Sofá.



**SERS170BSPDBA**

170 x 108 H82  
66.93" x 42.52" H32.28"



**SERS190BSPDBA**

190 x 108 H82  
74.80" x 42.52" H32.28"



**SERS210BSPDBA**

210 x 108 H82  
82.68" x 42.52" H32.28"

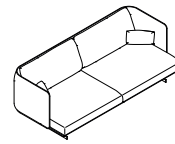

**SERS230BSPDBA**

230 x 108 H82  
90.55" x 42.52" H32.28"

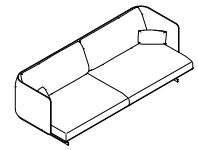

**SERS250BSPDBA**

250 x 108 H82  
98.43" x 42.52" H32.28"

| MEASUREMENT. MESURE. MEDIDA.            | REF.          | M.L. | COM / COL | 1        | 2        | 3        | 4        | 5        | L1       | L2       |
|---|---------------|------|-----------|----------|----------|----------|----------|----------|----------|----------|
| 170 x 108 H82   66.93" x 42.52" H32.28" | SERS170BSPDBA | 12   | 2.747,93  | 2.834,71 | 3.000,00 | 3.157,02 | 3.475,21 | 4.024,79 | 4.157,02 | 4.735,54 |
| 190 x 108 H82   74.80" x 42.52" H32.28" | SERS190BSPDBA | 12   | 2.896,69  | 2.983,47 | 3.132,23 | 3.289,26 | 3.603,31 | 4.157,02 | 4.280,99 | 4.838,84 |
| 210 x 108 H82   82.68" x 42.52" H32.28" | SERS210BSPDBA | 12.5 | 3.061,98  | 3.140,50 | 3.297,52 | 3.454,55 | 3.764,46 | 4.330,58 | 4.454,55 | 5.016,53 |
| 230 x 108 H82   90.55" x 42.52" H32.28" | SERS230BSPDBA | 12.5 | 3.297,52  | 3.404,96 | 3.545,45 | 3.710,74 | 4.024,79 | 4.595,04 | 4.710,74 | 5.285,12 |
| 250 x 108 H82   98.43" x 42.52" H32.28" | SERS250BSPDBA | 13   | 3.570,25  | 3.665,29 | 3.842,98 | 4.000,00 | 4.338,84 | 4.946,28 | 5.078,51 | 5.673,55 |

SERENE. Tables for sofas with 1 arm, without arms and corners. Tables pour canapés avec 1 accoudoir, sans accoudoirs et angles. Mesas para sofás con un brazo, sin brazos y rincones.



**SERME38**

38 x 92 H16  
14.96" x 36.22" H6.30"



**SERME94**

94 x 89 H16  
37.01" x 35.04" H6.30"

| MEASUREMENT. MESURE. MEDIDA.         | FINISHES. TRAITS. ACABADOS.   | REF.      | PRICE. PRIX. PRECIO. |
|--------------------------------------|---|-----------|----------------------|
| 38 x 92 H16   14.96" x 36.22" H6.30" | Natural oak. Chêne naturel. Roble natural.  | SERME38RN | 756,20               |
| 38 x 92 H16   14.96" x 36.22" H6.30" | American walnut. Noyer américain. Nogal americano.  | SERME38NA | 814,05               |
| 38 x 92 H16   14.96" x 36.22" H6.30" | Dark stained oak. Chêne teinté foncé. Roble teñido oscuro.  | SERME38RT | 756,20               |
| 38 x 92 H16   14.96" x 36.22" H6.30" | Oak painted in black with open-pore finish. Chêne laqué noir à pores ouverts. Roble lacado negro por abierto. | SERME38RL | 814,05               |
| 38 x 92 H16   14.96" x 36.22" H6.30" | Matt lacquer. Laque mate. Lacado mate.  | SERME38LA | 756,20               |
| 94 x 89 H16   37.01" x 35.04" H6.30" | Natural oak. Chêne naturel. Roble natural.  | SERME94RN | 888,43               |
| 94 x 89 H16   37.01" x 35.04" H6.30" | American walnut. Noyer américain. Nogal americano.  | SERME94NA | 962,81               |
| 94 x 89 H16   37.01" x 35.04" H6.30" | Dark stained oak. Chêne teinté foncé. Roble teñido oscuro.  | SERME94RT | 888,43               |
| 94 x 89 H16   37.01" x 35.04" H6.30" | Oak painted in black with open-pore finish. Chêne laqué noir à pores ouverts. Roble lacado negro por abierto. | SERME94RL | 962,81               |
| 94 x 89 H16   37.01" x 35.04" H6.30" | Matt lacquer. Laque mate. Lacado mate.  | SERME94LA | 888,43               |

## SERENE.

### PRICES. PRIX. PRECIOS.

SERENE. Furniture for sofas, sofas with 1 arm, and without arms. Meubles pour canapés, canapés avec 1 accoudoir et sans accoudoirs. Muebles para sofás, para sofás con 1 brazo y para sofás sin brazos.



**SERMU149**

149 x 25 H43

63.78" x 9.84" H16.93"



**SERMU169**

169 x 25 H43

66.54" x 9.84" H16.93"

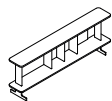

**SERMU189**

189 x 25 H43

74.41" x 9.84" H16.93"

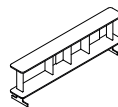

**SERMU209**

209 x 25 H43

82.28" x 9.84" H16.93"

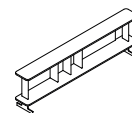

**SERMU229**

229 x 25 H43

90.16" x 9.84" H16.93"

| MEASUREMENT. MESURE. MEDIDA.          | FINISHES. TRAITS. ACABADOS.   | REF.       | PRICE. PRIX. PRECIO. |
|---------------------------------------|---|------------|----------------------|
| 149 x 25 H43   63.78" x 9.84" H16.93" | Natural oak. Chêne naturel. Roble natural.  | SERMU149RN | 1.161,16             |
| 149 x 25 H43   63.78" x 9.84" H16.93" | American walnut. Noyer américain. Nogal americano.  | SERMU149NA | 1.256,20             |
| 149 x 25 H43   63.78" x 9.84" H16.93" | Dark stained oak. Chêne teinté foncé. Roble teñido oscuro.  | SERMU149RT | 1.161,16             |
| 149 x 25 H43   63.78" x 9.84" H16.93" | Oak painted in black with open-pore finish. Chêne laqué noir à pores ouverts. Roble lacado negro por abierto. | SERMU149RL | 1.256,20             |
| 149 x 25 H43   63.78" x 9.84" H16.93" | Matt lacquer. Laque mate. Lacado mate.  | SERMU149LA | 1.161,16             |
| 169 x 25 H43   66.54" x 9.84" H16.93" | Natural oak. Chêne naturel. Roble natural.  | SERMU169RN | 1.235,54             |
| 169 x 25 H43   66.54" x 9.84" H16.93" | American walnut. Noyer américain. Nogal americano.  | SERMU169NA | 1.342,98             |
| 169 x 25 H43   66.54" x 9.84" H16.93" | Dark stained oak. Chêne teinté foncé. Roble teñido oscuro.  | SERMU169RT | 1.235,54             |
| 169 x 25 H43   66.54" x 9.84" H16.93" | Oak painted in black with open-pore finish. Chêne laqué noir à pores ouverts. Roble lacado negro por abierto. | SERMU169RL | 1.342,98             |
| 169 x 25 H43   66.54" x 9.84" H16.93" | Matt lacquer. Laque mate. Lacado mate.  | SERMU169LA | 1.235,54             |
| 189 x 25 H43   74.41" x 9.84" H16.93" | Natural oak. Chêne naturel. Roble natural.  | SERMU189RN | 1.355,37             |
| 189 x 25 H43   74.41" x 9.84" H16.93" | American walnut. Noyer américain. Nogal americano.  | SERMU189NA | 1.442,15             |
| 189 x 25 H43   74.41" x 9.84" H16.93" | Dark stained oak. Chêne teinté foncé. Roble teñido oscuro.  | SERMU189RT | 1.322,31             |
| 189 x 25 H43   74.41" x 9.84" H16.93" | Oak painted in black with open-pore finish. Chêne laqué noir à pores ouverts. Roble lacado negro por abierto. | SERMU189RL | 1.442,15             |
| 189 x 25 H43   74.41" x 9.84" H16.93" | Matt lacquer. Laque mate. Lacado mate.  | SERMU189LA | 1.322,31             |
| 209 x 25 H43   82.28" x 9.84" H16.93" | Natural oak. Chêne naturel. Roble natural.  | SERMU209RN | 1.396,69             |
| 209 x 25 H43   82.28" x 9.84" H16.93" | American walnut. Noyer américain. Nogal americano.  | SERMU209NA | 1.495,87             |
| 209 x 25 H43   82.28" x 9.84" H16.93" | Dark stained oak. Chêne teinté foncé. Roble teñido oscuro.  | SERMU209RT | 1.396,69             |
| 209 x 25 H43   82.28" x 9.84" H16.93" | Oak painted in black with open-pore finish. Chêne laqué noir à pores ouverts. Roble lacado negro por abierto. | SERMU209RL | 1.495,87             |
| 209 x 25 H43   82.28" x 9.84" H16.93" | Matt lacquer. Laque mate. Lacado mate.  | SERMU209LA | 1.396,69             |
| 229 x 25 H43   90.16" x 9.84" H16.93" | Natural oak. Chêne naturel. Roble natural.  | SERMU229RN | 1.508,26             |
| 229 x 25 H43   90.16" x 9.84" H16.93" | American walnut. Noyer américain. Nogal americano.  | SERMU229NA | 1.603,31             |
| 229 x 25 H43   90.16" x 9.84" H16.93" | Dark stained oak. Chêne teinté foncé. Roble teñido oscuro.  | SERMU229RT | 1.508,26             |
| 229 x 25 H43   90.16" x 9.84" H16.93" | Oak painted in black with open-pore finish. Chêne laqué noir à pores ouverts. Roble lacado negro por abierto. | SERMU229RL | 1.603,31             |
| 229 x 25 H43   90.16" x 9.84" H16.93" | Matt lacquer. Laque mate. Lacado mate.  | SERMU229LA | 1.508,26             |



SERENE.

PRICES. PRIX. PRECIOS.

SERENE. Furniture for chaise longue. Meubles pour chaise longue. Muebles para chaise longue.



**SERMU83**

83 x 25 H43  
32.68" x 9.84" H16.93"



**SERMU93**

93 x 25 H43  
36.61" x 9.84" H16.93"

| MEASUREMENT. MESURE. MEDIDA.         | FINISHES. TRAITS. ACABADOS.   | REF.      | PRICE. PRIX. PRECIO. |
|--------------------------------------|---|-----------|----------------------|
| 83 x 25 H43   32.68" x 9.84" H16.93" | Natural oak. Chêne naturel. Roble natural.  | SERMU83RN | 954,55               |
| 83 x 25 H43   32.68" x 9.84" H16.93" | American walnut. Noyer américain. Nogal americano.  | SERMU83NA | 1.020,66             |
| 83 x 25 H43   32.68" x 9.84" H16.93" | Dark stained oak. Chêne teinté foncé. Roble teñido oscuro.  | SERMU83RT | 954,55               |
| 83 x 25 H43   32.68" x 9.84" H16.93" | Oak painted in black with open-pore finish. Chêne laqué noir à pores ouverts. Roble lacado negro por abierto. | SERMU83RL | 1.020,66             |
| 83 x 25 H43   32.68" x 9.84" H16.93" | Matt lacquer. Laque mate. Lacado mate.  | SERMU83LA | 954,55               |
| 93 x 25 H43   36.61" x 9.84" H16.93" | Natural oak. Chêne naturel. Roble natural.  | SERMU93RN | 987,60               |
| 93 x 25 H43   36.61" x 9.84" H16.93" | American walnut. Noyer américain. Nogal americano.  | SERMU93NA | 1.041,32             |
| 93 x 25 H43   36.61" x 9.84" H16.93" | Dark stained oak. Chêne teinté foncé. Roble teñido oscuro.  | SERMU93RT | 987,60               |
| 93 x 25 H43   36.61" x 9.84" H16.93" | Oak painted in black with open-pore finish. Chêne laqué noir à pores ouverts. Roble lacado negro por abierto. | SERMU93RL | 1.041,32             |
| 93 x 25 H43   36.61" x 9.84" H16.93" | Matt lacquer. Laque mate. Lacado mate.  | SERMU93LA | 987,60               |

SERENE. Furniture for corner and sofa corner. Meubles pour angle et canapé angle. Muebles para rincón y sofá rincón.



**SERMU162**

162 x 25 H43  
63.78" x 9.84" H16.93"

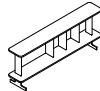

**SERMU172**

172 x 25 H43  
67.72" x 9.84" H16.93"

| MEASUREMENT. MESURE. MEDIDA.          | FINISHES. TRAITS. ACABADOS.   | REF.       | PRICE. PRIX. PRECIO. |
|---------------------------------------|---|------------|----------------------|
| 162 x 25 H43   63.78" x 9.84" H16.93" | Natural oak. Chêne naturel. Roble natural.  | SERMU162RN | 1.214,88             |
| 162 x 25 H43   63.78" x 9.84" H16.93" | American walnut. Noyer américain. Nogal americano.  | SERMU162NA | 1.314,05             |
| 162 x 25 H43   63.78" x 9.84" H16.93" | Dark stained oak. Chêne teinté foncé. Roble teñido oscuro.  | SERMU162RT | 1.214,88             |
| 162 x 25 H43   63.78" x 9.84" H16.93" | Oak painted in black with open-pore finish. Chêne laqué noir à pores ouverts. Roble lacado negro por abierto. | SERMU162RL | 1.314,05             |
| 162 x 25 H43   63.78" x 9.84" H16.93" | Matt lacquer. Laque mate. Lacado mate.  | SERMU162LA | 1.214,88             |
| 172 x 25 H43   67.72" x 9.84" H16.93" | Natural oak. Chêne naturel. Roble natural.  | SERMU172RN | 1.293,39             |
| 172 x 25 H43   67.72" x 9.84" H16.93" | American walnut. Noyer américain. Nogal americano.  | SERMU172NA | 1.421,49             |
| 172 x 25 H43   67.72" x 9.84" H16.93" | Dark stained oak. Chêne teinté foncé. Roble teñido oscuro.  | SERMU172RT | 1.293,39             |
| 172 x 25 H43   67.72" x 9.84" H16.93" | Oak painted in black with open-pore finish. Chêne laqué noir à pores ouverts. Roble lacado negro por abierto. | SERMU172RL | 1.421,49             |
| 172 x 25 H43   67.72" x 9.84" H16.93" | Matt lacquer. Laque mate. Lacado mate.  | SERMU172LA | 1.293,39             |

SERENE.

PRICES. PRIX. PRECIOS.

SEAT CUSHION 80 CM. COUSSIN DE L'ASSISE DE 80 CM. COJÍN DE ASIENTO DE 80 CM.

SERENE. Sofas with 1 arm. Canapés avec 1 accoudoir. Sofás con 1 brazo.



**SERSI85BSPDBA**

85 x 108 H82  
33.46"x 42.52" H32.28"  
IZQ.



**SERSI165BSPDBA**

165 x 108 H82  
64.96"x 42.52" H32.28"  
IZQ.

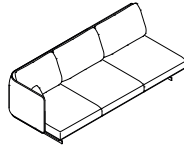

**SERSI245BSPDBA**

245 x 108 H82  
96.46"x 42.52" H32.28"  
IZQ.



**SERSD85BSPDBA**

85 x 108 H82  
33.46"x 42.52" H32.28"  
DER.



**SERSD165BSPDBA**

165 x 108 H82  
64.96"x 42.52" H32.28"  
DER.

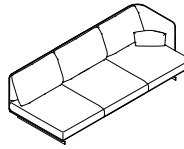

**SERSD245BSPDBA**

245 x 108 H82  
96.46"x 42.52" H32.28"  
DER.

| MEASUREMENT. MESURE. MEDIDA.           | REF.                            | M.L. | COM / COL | 1        | 2        | 3        | 4        | 5        | L1       | L2       |
|--|---------------------------------|------|-----------|----------|----------|----------|----------|----------|----------|----------|
| 85 x 108 H82   33.46"x 42.52" H32.28"  | SERSI85BSPDBA - SERSD85BSPDBA   | 7    | 1.702,48  | 1.756,20 | 1.834,71 | 1.904,96 | 2.070,25 | 2.351,24 | 2.429,75 | 2.694,21 |
| 165 x 108 H82   64.96"x 42.52" H32.28" | SERSI165BSPDBA - SERSD165BSPDBA | 10.5 | 2.561,98  | 2.640,50 | 2.772,73 | 2.913,22 | 3.185,95 | 3.681,82 | 3.805,79 | 4.314,05 |
| 245 x 108 H82   96.46"x 42.52" H32.28" | SERSI245BSPDBA - SERSD245BSPDBA | 15   | 3.483,47  | 3.603,31 | 3.797,52 | 4.000,00 | 4.400,83 | 5.136,36 | 5.285,12 | 5.995,87 |

SERENE. Sofas without arms. Canapés sans accoudoirs. Sofás sin brazos.

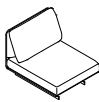

**SERS080BSPD**

80 x 108 H82  
31.50"x 42.52" H32.28"

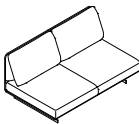

**SERS0160BSPD**

160 x 108 H82  
62.99"x 42.52" H32.28"

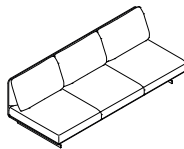

**SERS0240BSPD**

240 x 108 H82  
94.49"x 42.52" H32.28"

| MEASUREMENT. MESURE. MEDIDA.           | REF.         | M.L. | COM / COL | 1        | 2        | 3        | 4        | 5        | L1       | L2       |
|--|--------------|------|-----------|----------|----------|----------|----------|----------|----------|----------|
| 80 X 108 H82   31.50"x 42.52" H32.28"  | SERS080BSPD  | 6    | 1.553,72  | 1.607,44 | 1.652,89 | 1.731,40 | 1.842,98 | 2.070,25 | 2.123,97 | 2.334,71 |
| 160 x 108 H82   62.99"x 42.52" H32.28" | SERS0160BSPD | 9.5  | 2.388,43  | 2.458,68 | 2.578,51 | 2.702,48 | 2.946,28 | 3.376,03 | 3.483,47 | 3.929,75 |
| 240 x 108 H82   94.49"x 42.52" H32.28" | SERS0240BSPD | 14.5 | 3.305,79  | 3.429,75 | 3.603,31 | 3.789,26 | 4.148,76 | 4.805,79 | 4.954,55 | 5.611,57 |

SERENE.

PRICES. PRIX. PRECIOS.

SEAT CUSHION 80 CM. COUSSIN DE L'ASSISE DE 80 CM. COJÍN DE ASIENTO DE 80 CM.

SERENE. Corner and sofa corner. Angle et canapé angle. Rincón y sofá rincón.

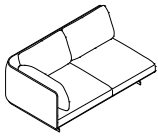

**SERRI184BSPD**

184 x 108 H82  
72.44"x 42.52" H32.28"  
IZQ.

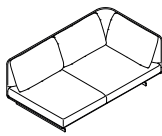

**SERRD184BSPD**

184 x 108 H82  
72.44"x 42.52" H32.28"  
DER.

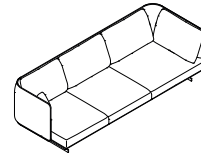

**SERSRI273BSPDBA**

273 x 108 H82  
107.48"x 42.52" H32.28"  
IZQ.

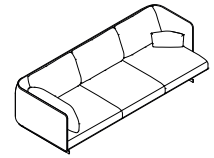

**SERSRD273BSPDBA**

273 x 108 H82  
107.48"x 42.52" H32.28"  
DER.

| MEASUREMENT. MESURE. MEDIDA.            | REF.                              | M.L. | COM / COL | 1        | 2        | 3        | 4        | 5        | L1       | L2       |
|---|-----------------------------------|------|-----------|----------|----------|----------|----------|----------|----------|----------|
| 184 x 108 H82   72.44"x 42.52" H32.28"  | SERRI184BSPD - SERRD184BSPD       | 11.5 | 2.851,24  | 2.946,28 | 3.095,04 | 3.264,46 | 3.561,98 | 4.111,57 | 4.235,54 | 4.789,26 |
| 273 x 108 H82   107.48"x 42.52" H32.28" | SERSRI273BSPDBA - SERSRD273BSPDBA | 16   | 4.008,26  | 4.140,50 | 4.376,03 | 4.611,57 | 5.095,04 | 5.933,88 | 6.119,83 | 6.958,68 |

SERENE. Ottomans. Poufs. Ottomans.



**SERP80BSPD**

80 x 104 H42  
31.50"x 40.94" H16.54"

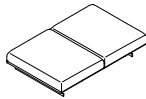

**SERP160BSPD**

160 x 104 H42  
62.99"x 40.94" H16.54"

| MEASUREMENT. MESURE. MEDIDA.           | REF.        | M.L. | COM / COL | 1        | 2        | 3        | 4        | 5        | L1       | L2       |
|--|-------------|------|-----------|----------|----------|----------|----------|----------|----------|----------|
| 80 x 104 H42   31.5"x 40.94" H16.54"   | SERP80BSPD  | 3    | 1.020,66  | 1.028,93 | 1.074,38 | 1.107,44 | 1.169,42 | 1.293,39 | 1.318,18 | 1.442,15 |
| 160 x 104 H42   62.99"x 40.94" H16.54" | SERP160BSPD | 5    | 1.632,23  | 1.677,69 | 1.747,93 | 1.801,65 | 1.958,68 | 2.185,95 | 2.239,67 | 2.483,47 |

SERENE. Chaise longues.

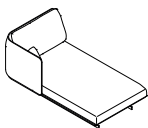

**SERCLI98BSPDBA**

98 x 170 H82  
42.52"x 66.93" H32.28"  
IZQ.



**SERCLD98BSPDBA**

98 x 170 H82  
42.52"x 66.93" H32.28"  
DER.

| MEASUREMENT. MESURE. MEDIDA.          | REF.                            | M.L. | COM / COL | 1        | 2        | 3        | 4        | 5        | L1       | L2       |
|---------------------------------------|---------------------------------|------|-----------|----------|----------|----------|----------|----------|----------|----------|
| 98 x 170 H82   38.58"x 66.93" H32.28" | SERCLI98BSPDBA - SERCLD98BSPDBA | 8    | 2.231,40  | 2.289,26 | 2.388,43 | 2.483,47 | 2.677,69 | 3.024,79 | 3.095,04 | 3.454,55 |

## SERENE.

PRICES. PRIX. PRECIOS.

SEAT CUSHION 90 CM. COUSSIN DE L'ASSISE DE 90 CM. COJÍN DE ASIENTO DE 90 CM.

SERENE. Sofas with 1 arm. Canapés avec 1 accoudoir. Sofás con 1 brazo.



**SERSI95BSPDBA**

95 x 108 H82  
37.40" x 42.52" H32.28"  
IZQ.

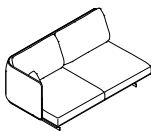

**SERSI185BSPDBA**

185 x 108 H82  
72.83" x 42.52" H32.28"  
IZQ.

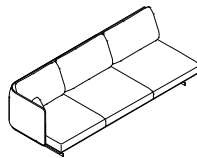

**SERSI275BSPDBA**

275 x 108 H82  
108.27" x 42.52" H32.28"  
IZQ.



**SERSD95BSPDBA**

95 x 108 H82  
37.40" x 42.52" H32.28"  
DER.

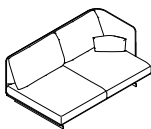

**SERSD185BSPDBA**

185 x 108 H82  
72.83" x 42.52" H32.28"  
DER.

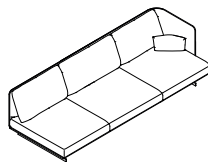

**SERSD275BSPDBA**

275 x 108 H82  
108.27" x 42.52" H32.28"  
DER.

| MEASUREMENT. MESURE. MEDIDA.             | REF.                            | M.L. | COM / COL | 1        | 2        | 3        | 4        | 5        | L1       | L2       |
|--|---------------------------------|------|-----------|----------|----------|----------|----------|----------|----------|----------|
| 95 x 108 H82   37.40" x 42.52" H32.28"   | SERSI95BSPDBA - SERSD95BSPDBA   | 8.5  | 1.793,39  | 1.842,98 | 1.929,75 | 2.000,00 | 2.169,42 | 2.458,68 | 2.528,93 | 2.805,79 |
| 185 x 108 H82   72.83" x 42.52" H32.28"  | SERSI185BSPDBA - SERSD185BSPDBA | 11.5 | 2.772,73  | 2.851,24 | 2.983,47 | 3.132,23 | 3.429,75 | 3.929,75 | 4.033,06 | 4.541,32 |
| 275 x 108 H82   108.27" x 42.52" H32.28" | SERSI275BSPDBA - SERSD275BSPDBA | 16   | 3.764,46  | 3.867,77 | 4.078,51 | 4.272,73 | 4.673,55 | 5.409,09 | 5.566,12 | 6.293,39 |

SERENE. Sofas without arms. Canapés sans accoudoirs. Sofás sin brazos.



**SERS090BSPD**

90 x 108 H82  
35.43" x 42.52" H32.28"

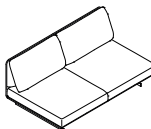

**SERS0180BSPD**

180 x 108 H82  
70.87" x 42.52" H32.28"

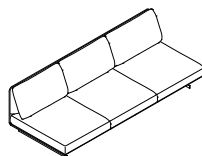

**SERS0270BSPD**

270 x 108 H82  
106.30" x 42.52" H32.28"

| MEASUREMENT. MESURE. MEDIDA.             | REF.         | M.L. | COM / COL | 1        | 2        | 3        | 4        | 5        | L1       | L2       |
|--|--------------|------|-----------|----------|----------|----------|----------|----------|----------|----------|
| 90 X 108 H82   35.43" x 42.52" H32.28"   | SERS090BSPD  | 7.5  | 1.644,63  | 1.677,69 | 1.747,93 | 1.801,65 | 1.950,41 | 2.177,69 | 2.231,40 | 2.466,94 |
| 180 x 108 H82   70.87" x 42.52" H32.28"  | SERS0180BSPD | 11   | 2.586,78  | 2.657,02 | 2.780,99 | 2.913,22 | 3.148,76 | 3.595,04 | 3.681,82 | 4.132,23 |
| 270 x 108 H82   106.30" x 42.52" H32.28" | SERS0270BSPD | 15.5 | 3.570,25  | 3.673,55 | 3.859,50 | 4.041,32 | 4.421,49 | 5.078,51 | 5.243,80 | 5.884,30 |

SERENE.

PRICES. PRIX. PRECIOS.

SEAT CUSHION 90 CM. COUSSIN DE L'ASSISE DE 90 CM. COJÍN DE ASIENTO DE 90 CM.

SERENE. Corner and sofa corner. Angle et canapé angle. Rincón y sofá rincón.

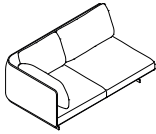

**SERRI194BSPD**

194 x 108 H82  
76.38" x 42.52" H32.28"  
IZQ.



**SERRD194BSPD**

194 x 108 H82  
76.38" x 42.52" H32.28"  
DER.

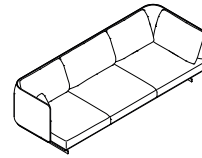

**SERSRI293BSPDBA**

293 x 108 H82  
115.35" x 42.52" H32.28"  
IZQ.

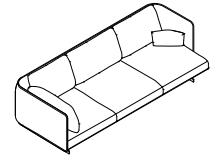

**SERSRD293BSPDBA**

293 x 108 H82  
115.35" x 42.52" H32.28"  
DER.

| MEASUREMENT. MESURE. MEDIDA.             | REF.                              | M.L. | COM / COL | 1        | 2        | 3        | 4        | 5        | L1       | L2       |
|--|-----------------------------------|------|-----------|----------|----------|----------|----------|----------|----------|----------|
| 194 x 108 H82   76.38" x 42.52" H32.28"  | SERRI194BSPD - SERRD194BSPD       | 11.5 | 2.851,24  | 2.946,28 | 3.095,04 | 3.264,46 | 3.561,98 | 4.111,57 | 4.235,54 | 4.789,26 |
| 293 x 108 H82   115.35" x 42.52" H32.28" | SERSRI293BSPDBA - SERSRD293BSPDBA | 16.5 | 4.243,80  | 4.376,03 | 4.628,10 | 4.859,50 | 5.330,58 | 6.190,08 | 6.371,90 | 7.239,67 |

SERENE. Ottomans. Poufs. Ottomans.

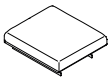

**SERP90BSPD**

90 x 104 H42  
35.43" x 40.94" H16.54"

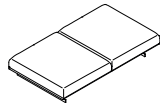

**SERP180BSPD**

180 x 104 H42  
70.87" x 40.94" H16.54"

| MEASUREMENT. MESURE. MEDIDA.            | REF.        | M.L. | COM / COL | 1        | 2        | 3        | 4        | 5        | L1       | L2       |
|---|-------------|------|-----------|----------|----------|----------|----------|----------|----------|----------|
| 90 x 104 H42   35.43" x 40.94" H16.54"  | SERP90BSPD  | 3    | 1.082,64  | 1.107,44 | 1.144,63 | 1.177,69 | 1.272,73 | 1.421,49 | 1.458,68 | 1.607,44 |
| 180 x 104 H42   70.87" x 40.94" H16.54" | SERP180BSPD | 5    | 1.739,67  | 1.772,73 | 1.851,24 | 1.929,75 | 2.082,64 | 2.334,71 | 2.404,96 | 2.657,02 |

SERENE. Chaise longues.

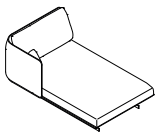

**SERCLI108BSPDBA**

108 x 170 H82  
42.52" x 32.28" H32.28"  
IZQ.

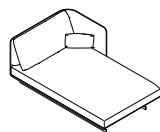

**SERCLD108BSPDBA**

108 x 170 H82  
42.52" x 32.28" H32.28"  
DER.

| MEASUREMENT. MESURE. MEDIDA.            | REF.                              | M.L. | COM / COL | 1        | 2        | 3        | 4        | 5        | L1       | L2       |
|---|-----------------------------------|------|-----------|----------|----------|----------|----------|----------|----------|----------|
| 108 x 170 H82   42.52" x 32.28" H32.28" | SERCLI108BSPDBA - SERCLD108BSPDBA | 8    | 2.318,18  | 2.388,43 | 2.475,21 | 2.578,51 | 2.764,46 | 3.115,70 | 3.202,48 | 3.553,72 |

# SERENE.

# SOFA. CANAPÉ. SOFÁ.



Designer  
Mario Ruiz

STYLE. ESTILO.  
Singular

VERSION. VERSIÓN.  
Suspended base. Base suspendue. Base suspendida.

VARIANTS. VARIANTES.  
Deluxe depth. Profondeur deluxe. Profundidad deluxe. (108 cm - 42.52 in)  
Low arm. Accoudoir bas. Brazo bajo.

## FEATURES. TRAITS. CARACTERÍSTICAS.

**The high backrest costs an extra 47 euros per unit. Le dossier haut coûte 47 euros de plus par unité. El respaldo alto tiene un coste extra de 47 euros por unidad.**

Removable upholstery in seat, back and auxiliary cushions.

Wooden frame covered with flexible cold shaped polyurethane foam and polyester fibre.

Suspension consisting of fibreglass reinforced plastic slats.

Seat cushions in different polyurethane foam densities, with surface padding in fibre. Back cushions stuffed with polyester fibre and washed, sterilised down. Auxiliary cushions stuffed with polyester fibre and washed, sterilised down.

Metal bases coated in polyester powder paint with a manganese topcoat and LDPE stops.

Two back cushion heights available: Standard (82 cm - 32.28 in) or High (92 cm - 36.22)

Tapiserie déhoussable sur les coussins de l'assise, coussins du dossier et coussins auxiliaires.

Cadre en bois recouvert de mousse de polyuréthane souple à froid et de fibre de polyester.

Suspension au moyen de lattes renforcées avec de la fibre de verre.

Coussins de l'assise réalisés dans différentes densités de mousse polyuréthane, matelassés en surface avec du fibre. Coussins du dossier garnis de fibre de polyester et plumes lavées et stérilisées. Coussins auxiliaires garnis de fibre de polyester et plumes lavées et stérilisées.

Bases métalliques recouverts en peinture polyester en poudre finition manganèse avec butées en PEBD.

Deux hauteurs de coussin pour les dossiers disponibles : Standard (82 cm) ou Haut (92 cm)

Tapicería desenfundable en cojines de asiento, cojines de respaldo y cojines auxiliares.

Bastidor de madera recubierto de espuma de poliuretano flexible en frío y fibra de poliéster.

Suspensión mediante lamas de plástico reforzadas con fibra de vidrio.

Cojines de asiento realizados en distintas densidades de espuma de poliuretano, acolchado en la superficie con fibra. Cojines de respaldo rellenos de fibra de poliéster y pluma lavada y esterilizada. Cojines auxiliares rellenos de fibra de poliéster y pluma lavada y esterilizada.

Bases metálicas recubiertas en pintura poliéster en polvo acabado manganeso con topes de LDPE.

Dos alturas de respaldo disponibles: Estándar (82 cm) o Alto (92 cm)

## SERENE.

### GENERAL MEASUREMENTS. MESURES GÉNÉRALES. MEDIDAS GENERALES.

---

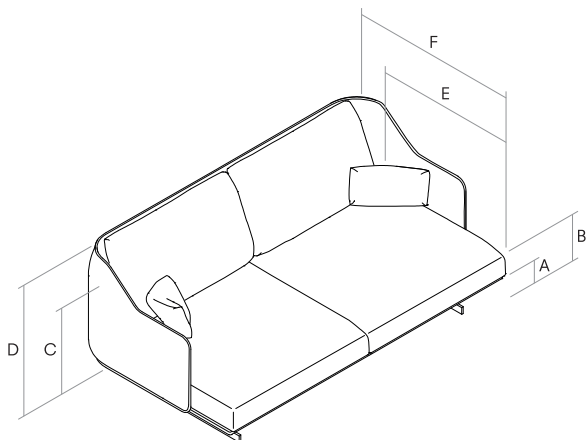

- A. Base height. Hauteur de base. Altura de base. 13 cm - 5.12"
- B. Seat height. Hauteur du siège. Altura de asiento. 42 cm - 16.54"
- C. Arm height. Hauteur du bras. Altura de brazo. 56 cm - 22.05"
- D. Backrest height. Hauteur du dossier. Altura de respaldo. 82 cm - 32.28"
- E. Seat depth. Profondeur d'assise. Profundidad de sentada. 68 cm - 26.77"
- F. Depth. Profondeur. Profundidad. 108 cm - 42.52"

### FINISHES. TRAITS. ACABADOS.

---

Finishes for the metal bases. Finitions des pieds métalliques. Acabados de las patas metálicas.

---

Polyester powder paint. Peinture polyester en poudre. Pintura poliéster en polvo.

---



Manganese metal.  
Métal manganèse.  
Metal manganeso.

### OPTIONAL BACK CUSHIONS. COUSSINS DU DOSSIER EN OPTION. COJINES DE RESPALDO OPCIONALES.

---

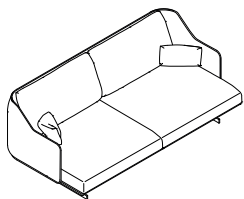

Standard option. Option standard. Opción estándar.  
Backrest height. Hauteur du dossier. Altura de respaldo.  
**82 cm - 32.28"**

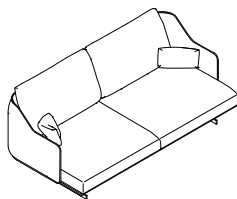

Premium option. Option premium. Opción premium.  
Backrest height. Hauteur du dossier. Altura de respaldo.  
**92 cm - 36.22"**

## SERENE.

### FINISHES. TRAITS. ACABADOS.

Wood finishes. Finitions bois. Acabado de la madera.



**RN**  
Natural oak.  
Chêne naturel.  
Roble natural.



**NA**  
Natural american walnut.  
Noyer américain.  
Nogal americano.



**RT**  
Dark stained oak.  
Chêne teint foncée.  
Roble teñido oscuro.



**RL**  
Oak painted in black with open-pore finish.  
Chêne laqué noir à pores ouverts.  
Roble lacado negro por abierto.

Lacquered. Laqué. Lacados.



SEDA



ALOE



KHAKI



BRICK











RUBI



KOKOA

## CONFIGURATOR.

Compatibility between furniture and upholstered elements. Compatibilité entre les meubles et les éléments tapissés. Compatibilidad entre mobiliario y elementos tapizados.

|  | REFERENCE.      | Supported references. Références compatibles. Referencias compatibles. |                                   |              |
|--|-----------------|--|-----------------------------------|--------------|
|  | <b>SERMU149</b> | SERS170BSPDBB  | SERSI165BSPDBB - SERSD165BSPDBB   | SERS0160BSPD |
|  | <b>SERMU169</b> | SERS190BSPDBB  | SERSI185BSPDBB - SERSD185BSPDBB   | SERS0180BSPD |
|  | <b>SERMU189</b> | SERS210BSPDBB  |                                   |              |
|  | <b>SERMU209</b> | SERS230BSPDBB  |                                   |              |
|  | <b>SERMU229</b> | SERS250BSPDBB  | SERSI245BSPDBB - SERSD245BSPDBB   | SERS0240BSPD |
|  | <b>SERMU162</b> | SERRI174BSPD - SERRD174BSPD  | SERSRI263BSPDBB - SERSRD263BSPDBB |              |
|  | <b>SERMU172</b> | SERRI184BSPD - SERRD184BSPD  | SERSRI283BSPDBB - SERSRD283BSPDBB |              |
|  | <b>SERMU83</b>  | SERCLI98BSPDBB - SERCLD98BSPDBB  |                                   |              |
|  | <b>SERMU93</b>  | SERCLI108BSPDBB - SERCLD108BSPDBB                                      |                                   |              |



## SERENE.

PRICES. PRIX. PRECIOS.

SERENE. Sofa. Canapé. Sofá.



**SERS170BSPDBB**

170 x 108 H82  
66.93" x 42.52" H32.28"



**SERS190BSPDBB**

190 x 108 H82  
74.80" x 42.52" H32.28"

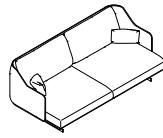

**SERS210BSPDBB**

210 x 108 H82  
82.68" x 42.52" H32.28"

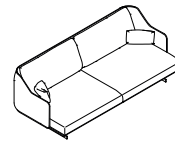

**SERS230BSPDBB**

230 x 108 H82  
90.55" x 42.52" H32.28"

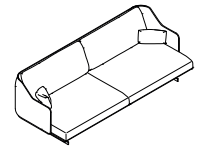

**SERS250BSPDBB**

250 x 108 H82  
98.43" x 42.52" H32.28"

| MEASUREMENT. MESURE. MEDIDA.            | REF.          | M.L. | COM / COL | 1        | 2        | 3        | 4        | 5        | L1       | L2       |
|---|---------------|------|-----------|----------|----------|----------|----------|----------|----------|----------|
| 170 x 108 H82   66.93" x 42.52" H32.28" | SERS170BSPDBB | 12   | 2.747,93  | 2.834,71 | 3.000,00 | 3.157,02 | 3.475,21 | 4.024,79 | 4.157,02 | 4.735,54 |
| 190 x 108 H82   74.80" x 42.52" H32.28" | SERS190BSPDBB | 12   | 2.896,69  | 2.983,47 | 3.132,23 | 3.289,26 | 3.603,31 | 4.157,02 | 4.280,99 | 4.838,84 |
| 210 x 108 H82   82.68" x 42.52" H32.28" | SERS210BSPDBB | 12.5 | 3.061,98  | 3.140,50 | 3.297,52 | 3.454,55 | 3.764,46 | 4.330,58 | 4.454,55 | 5.016,53 |
| 230 x 108 H82   90.55" x 42.52" H32.28" | SERS230BSPDBB | 12.5 | 3.297,52  | 3.404,96 | 3.545,45 | 3.710,74 | 4.024,79 | 4.595,04 | 4.710,74 | 5.285,12 |
| 250 x 108 H82   98.43" x 42.52" H32.28" | SERS250BSPDBB | 13   | 3.570,25  | 3.665,29 | 3.842,98 | 4.000,00 | 4.338,84 | 4.946,28 | 5.078,51 | 5.673,55 |

SERENE. Tables for sofas with 1 arm, without arms and corners. Tables pour canapés avec 1 accoudoir, sans accoudoirs et angles. Mesas para sofás con un brazo, sin brazos y rincones.



**SERME38**

38 x 92 H16  
14.96" x 36.22" H6.30"



**SERME94**

94 x 89 H16  
37.01" x 35.04" H6.30"

| MEASUREMENT. MESURE. MEDIDA.         | FINISHES. TRAITS. ACABADOS.   | REF.      | PRICE. PRIX. PRECIO. |
|--------------------------------------|---|-----------|----------------------|
| 38 x 92 H16   14.96" x 36.22" H6.30" | Natural oak. Chêne naturel. Roble natural.  | SERME38RN | 756,20               |
| 38 x 92 H16   14.96" x 36.22" H6.30" | American walnut. Noyer américain. Nogal americano.  | SERME38NA | 814,05               |
| 38 x 92 H16   14.96" x 36.22" H6.30" | Dark stained oak. Chêne teinté foncé. Roble teñido oscuro.  | SERME38RT | 756,20               |
| 38 x 92 H16   14.96" x 36.22" H6.30" | Oak painted in black with open-pore finish. Chêne laqué noir à pores ouverts. Roble lacado negro por abierto. | SERME38RL | 814,05               |
| 38 x 92 H16   14.96" x 36.22" H6.30" | Matt lacquer. Laque mate. Lacado mate.  | SERME38LA | 756,20               |
| 94 x 89 H16   37.01" x 35.04" H6.30" | Natural oak. Chêne naturel. Roble natural.  | SERME94RN | 888,43               |
| 94 x 89 H16   37.01" x 35.04" H6.30" | American walnut. Noyer américain. Nogal americano.  | SERME94NA | 962,81               |
| 94 x 89 H16   37.01" x 35.04" H6.30" | Dark stained oak. Chêne teinté foncé. Roble teñido oscuro.  | SERME94RT | 888,43               |
| 94 x 89 H16   37.01" x 35.04" H6.30" | Oak painted in black with open-pore finish. Chêne laqué noir à pores ouverts. Roble lacado negro por abierto. | SERME94RL | 962,81               |
| 94 x 89 H16   37.01" x 35.04" H6.30" | Matt lacquer. Laque mate. Lacado mate.  | SERME94LA | 888,43               |

## SERENE.

### PRICES. PRIX. PRECIOS.

SERENE. Furniture for sofas, sofas with 1 arm, and without arms. Meubles pour canapés, canapés avec 1 accoudoir et sans accoudoirs. Muebles para sofás, para sofás con 1 brazo y para sofás sin brazos.



**SERMU149**

149 x 25 H43  
63.78" x 9.84" H16.93"



**SERMU169**

169 x 25 H43  
66.54" x 9.84" H16.93"

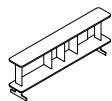

**SERMU189**

189 x 25 H43  
74.41" x 9.84" H16.93"

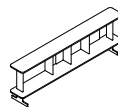

**SERMU209**

209 x 25 H43  
82.28" x 9.84" H16.93"

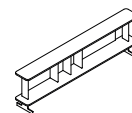

**SERMU229**

229 x 25 H43  
90.16" x 9.84" H16.93"

| MEASUREMENT. MESURE. MEDIDA.          | FINISHES. TRAITS. ACABADOS.   | REF.       | PRICE. PRIX. PRECIO. |
|---------------------------------------|---|------------|----------------------|
| 149 x 25 H43   63.78" x 9.84" H16.93" | Natural oak. Chêne naturel. Roble natural.  | SERMU149RN | 1.161,16             |
| 149 x 25 H43   63.78" x 9.84" H16.93" | American walnut. Noyer américain. Nogal americano.  | SERMU149NA | 1.256,20             |
| 149 x 25 H43   63.78" x 9.84" H16.93" | Dark stained oak. Chêne teinté foncé. Roble teñido oscuro.  | SERMU149RT | 1.161,16             |
| 149 x 25 H43   63.78" x 9.84" H16.93" | Oak painted in black with open-pore finish. Chêne laqué noir à pores ouverts. Roble lacado negro por abierto. | SERMU149RL | 1.256,20             |
| 149 x 25 H43   63.78" x 9.84" H16.93" | Matt lacquer. Laque mate. Lacado mate.  | SERMU149LA | 1.161,16             |
| 169 x 25 H43   66.54" x 9.84" H16.93" | Natural oak. Chêne naturel. Roble natural.  | SERMU169RN | 1.235,54             |
| 169 x 25 H43   66.54" x 9.84" H16.93" | American walnut. Noyer américain. Nogal americano.  | SERMU169NA | 1.342,98             |
| 169 x 25 H43   66.54" x 9.84" H16.93" | Dark stained oak. Chêne teinté foncé. Roble teñido oscuro.  | SERMU169RT | 1.235,54             |
| 169 x 25 H43   66.54" x 9.84" H16.93" | Oak painted in black with open-pore finish. Chêne laqué noir à pores ouverts. Roble lacado negro por abierto. | SERMU169RL | 1.342,98             |
| 169 x 25 H43   66.54" x 9.84" H16.93" | Matt lacquer. Laque mate. Lacado mate.  | SERMU169LA | 1.235,54             |
| 189 x 25 H43   74.41" x 9.84" H16.93" | Natural oak. Chêne naturel. Roble natural.  | SERMU189RN | 1.355,37             |
| 189 x 25 H43   74.41" x 9.84" H16.93" | American walnut. Noyer américain. Nogal americano.  | SERMU189NA | 1.442,15             |
| 189 x 25 H43   74.41" x 9.84" H16.93" | Dark stained oak. Chêne teinté foncé. Roble teñido oscuro.  | SERMU189RT | 1.322,31             |
| 189 x 25 H43   74.41" x 9.84" H16.93" | Oak painted in black with open-pore finish. Chêne laqué noir à pores ouverts. Roble lacado negro por abierto. | SERMU189RL | 1.442,15             |
| 189 x 25 H43   74.41" x 9.84" H16.93" | Matt lacquer. Laque mate. Lacado mate.  | SERMU189LA | 1.322,31             |
| 209 x 25 H43   82.28" x 9.84" H16.93" | Natural oak. Chêne naturel. Roble natural.  | SERMU209RN | 1.396,69             |
| 209 x 25 H43   82.28" x 9.84" H16.93" | American walnut. Noyer américain. Nogal americano.  | SERMU209NA | 1.495,87             |
| 209 x 25 H43   82.28" x 9.84" H16.93" | Dark stained oak. Chêne teinté foncé. Roble teñido oscuro.  | SERMU209RT | 1.396,69             |
| 209 x 25 H43   82.28" x 9.84" H16.93" | Oak painted in black with open-pore finish. Chêne laqué noir à pores ouverts. Roble lacado negro por abierto. | SERMU209RL | 1.495,87             |
| 209 x 25 H43   82.28" x 9.84" H16.93" | Matt lacquer. Laque mate. Lacado mate.  | SERMU209LA | 1.396,69             |
| 229 x 25 H43   90.16" x 9.84" H16.93" | Natural oak. Chêne naturel. Roble natural.  | SERMU229RN | 1.508,26             |
| 229 x 25 H43   90.16" x 9.84" H16.93" | American walnut. Noyer américain. Nogal americano.  | SERMU229NA | 1.603,31             |
| 229 x 25 H43   90.16" x 9.84" H16.93" | Dark stained oak. Chêne teinté foncé. Roble teñido oscuro.  | SERMU229RT | 1.508,26             |
| 229 x 25 H43   90.16" x 9.84" H16.93" | Oak painted in black with open-pore finish. Chêne laqué noir à pores ouverts. Roble lacado negro por abierto. | SERMU229RL | 1.603,31             |
| 229 x 25 H43   90.16" x 9.84" H16.93" | Matt lacquer. Laque mate. Lacado mate.  | SERMU229LA | 1.508,26             |

SERENE.

PRICES. PRIX. PRECIOS.

SERENE. Furniture for chaise longue. Meubles pour chaise longue. Muebles para chaise longue.



**SERMU83**

83 x 25 H43  
32.68" x 9.84" H16.93"



**SERMU93**

93 x 25 H43  
36.61" x 9.84" H16.93"

| MEASUREMENT. MESURE. MEDIDA.         | FINISHES. TRAITS. ACABADOS.   | REF.      | PRICE. PRIX. PRECIO. |
|--------------------------------------|---|-----------|----------------------|
| 83 x 25 H43   32.68" x 9.84" H16.93" | Natural oak. Chêne naturel. Roble natural.  | SERMU83RN | 954,55               |
| 83 x 25 H43   32.68" x 9.84" H16.93" | American walnut. Noyer américain. Nogal americano.  | SERMU83NA | 1.020,66             |
| 83 x 25 H43   32.68" x 9.84" H16.93" | Dark stained oak. Chêne teinté foncé. Roble teñido oscuro.  | SERMU83RT | 954,55               |
| 83 x 25 H43   32.68" x 9.84" H16.93" | Oak painted in black with open-pore finish. Chêne laqué noir à pores ouverts. Roble lacado negro por abierto. | SERMU83RL | 1.020,66             |
| 83 x 25 H43   32.68" x 9.84" H16.93" | Matt lacquer. Laque mate. Lacado mate.  | SERMU83LA | 954,55               |
| 93 x 25 H43   36.61" x 9.84" H16.93" | Natural oak. Chêne naturel. Roble natural.  | SERMU93RN | 987,60               |
| 93 x 25 H43   36.61" x 9.84" H16.93" | American walnut. Noyer américain. Nogal americano.  | SERMU93NA | 1.041,32             |
| 93 x 25 H43   36.61" x 9.84" H16.93" | Dark stained oak. Chêne teinté foncé. Roble teñido oscuro.  | SERMU93RT | 987,60               |
| 93 x 25 H43   36.61" x 9.84" H16.93" | Oak painted in black with open-pore finish. Chêne laqué noir à pores ouverts. Roble lacado negro por abierto. | SERMU93RL | 1.041,32             |
| 93 x 25 H43   36.61" x 9.84" H16.93" | Matt lacquer. Laque mate. Lacado mate.  | SERMU93LA | 987,60               |

SERENE. Furniture for corner and sofa corner. Meubles pour angle et canapé angle. Muebles para rincón y sofá rincón.



**SERMU162**

162 x 25 H43  
63.78" x 9.84" H16.93"

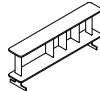

**SERMU172**

172 x 25 H43  
67.72" x 9.84" H16.93"

| MEASUREMENT. MESURE. MEDIDA.          | FINISHES. TRAITS. ACABADOS.   | REF.       | PRICE. PRIX. PRECIO. |
|---------------------------------------|---|------------|----------------------|
| 162 x 25 H43   63.78" x 9.84" H16.93" | Natural oak. Chêne naturel. Roble natural.  | SERMU162RN | 1.214,88             |
| 162 x 25 H43   63.78" x 9.84" H16.93" | American walnut. Noyer américain. Nogal americano.  | SERMU162NA | 1.314,05             |
| 162 x 25 H43   63.78" x 9.84" H16.93" | Dark stained oak. Chêne teinté foncé. Roble teñido oscuro.  | SERMU162RT | 1.214,88             |
| 162 x 25 H43   63.78" x 9.84" H16.93" | Oak painted in black with open-pore finish. Chêne laqué noir à pores ouverts. Roble lacado negro por abierto. | SERMU162RL | 1.314,05             |
| 162 x 25 H43   63.78" x 9.84" H16.93" | Matt lacquer. Laque mate. Lacado mate.  | SERMU162LA | 1.214,88             |
| 172 x 25 H43   67.72" x 9.84" H16.93" | Natural oak. Chêne naturel. Roble natural.  | SERMU172RN | 1.293,39             |
| 172 x 25 H43   67.72" x 9.84" H16.93" | American walnut. Noyer américain. Nogal americano.  | SERMU172NA | 1.421,49             |
| 172 x 25 H43   67.72" x 9.84" H16.93" | Dark stained oak. Chêne teinté foncé. Roble teñido oscuro.  | SERMU172RT | 1.293,39             |
| 172 x 25 H43   67.72" x 9.84" H16.93" | Oak painted in black with open-pore finish. Chêne laqué noir à pores ouverts. Roble lacado negro por abierto. | SERMU172RL | 1.421,49             |
| 172 x 25 H43   67.72" x 9.84" H16.93" | Matt lacquer. Laque mate. Lacado mate.  | SERMU172LA | 1.293,39             |

## SERENE.

PRICES. PRIX. PRECIOS.

SEAT CUSHION 80 CM. COUSSIN DE L'ASSISE DE 80 CM. COJÍN DE ASIENTO DE 80 CM.

SERENE. Sofas with 1 arm. Canapés avec 1 accoudoir. Sofás con 1 brazo.

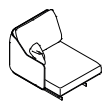

**SERSI85BSPDBB**

85 x 108 H82  
33.46"x 42.52" H32.28"  
IZQ.

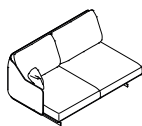

**SERSI165BSPDBB**

165 x 108 H82  
64.96"x 42.52" H32.28"  
IZQ.

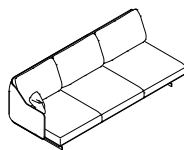

**SERSI245BSPDBB**

245 x 108 H82  
96.46"x 42.52" H32.28"  
IZQ.



**SERSD85BSPDBB**

85 x 108 H82  
33.46"x 42.52" H32.28"  
DER.



**SERSD165BSPDBB**

165 x 108 H82  
64.96"x 42.52" H32.28"  
DER.

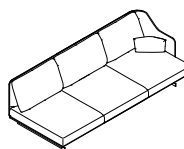

**SERSD245BSPDBB**

245 x 108 H82  
96.46"x 42.52" H32.28"  
DER.

| MEASUREMENT. MESURE. MEDIDA.           | REF.                            | M.L. | COM / COL | 1        | 2        | 3        | 4        | 5        | L1       | L2       |
|--|---------------------------------|------|-----------|----------|----------|----------|----------|----------|----------|----------|
| 85 x 108 H82   33.46"x 42.52" H32.28"  | SERSI85BSPDBB - SERSD85BSPDBB   | 7    | 1.702,48  | 1.756,20 | 1.834,71 | 1.904,96 | 2.070,25 | 2.351,24 | 2.429,75 | 2.694,21 |
| 165 x 108 H82   64.96"x 42.52" H32.28" | SERSI165BSPDBB - SERSD165BSPDBB | 10.5 | 2.561,98  | 2.640,50 | 2.772,73 | 2.913,22 | 3.185,95 | 3.681,82 | 3.805,79 | 4.314,05 |
| 245 x 108 H82   96.46"x 42.52" H32.28" | SERSI245BSPDBB - SERSD245BSPDBB | 15   | 3.483,47  | 3.603,31 | 3.797,52 | 4.000,00 | 4.400,83 | 5.136,36 | 5.285,12 | 5.995,87 |

SERENE. Sofas without arms. Canapés sans accoudoirs. Sofás sin brazos.

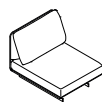

**SERS080BSPD**

80 x 108 H82  
31.50"x 42.52" H32.28"

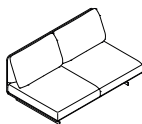

**SERS0160BSPD**

160 x 108 H82  
62.99"x 42.52" H32.28"

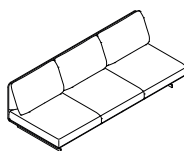

**SERS0240BSPD**

240 x 108 H82  
94.49"x 42.52" H32.28"

| MEASUREMENT. MESURE. MEDIDA.           | REF.         | M.L. | COM / COL | 1        | 2        | 3        | 4        | 5        | L1       | L2       |
|--|--------------|------|-----------|----------|----------|----------|----------|----------|----------|----------|
| 80 X 108 H82   31.50"x 42.52" H32.28"  | SERS080BSPD  | 6    | 1.553,72  | 1.607,44 | 1.652,89 | 1.731,40 | 1.842,98 | 2.070,25 | 2.123,97 | 2.334,71 |
| 160 x 108 H82   62.99"x 42.52" H32.28" | SERS0160BSPD | 9.5  | 2.388,43  | 2.458,68 | 2.578,51 | 2.702,48 | 2.946,28 | 3.376,03 | 3.483,47 | 3.929,75 |
| 240 x 108 H82   94.49"x 42.52" H32.28" | SERS0240BSPD | 14.5 | 3.305,79  | 3.429,75 | 3.603,31 | 3.789,26 | 4.148,76 | 4.805,79 | 4.954,55 | 5.611,57 |

SERENE.

PRICES. PRIX. PRECIOS.

SEAT CUSHION 80 CM. COUSSIN DE L'ASSISE DE 80 CM. COJÍN DE ASIENTO DE 80 CM.

SERENE. Corner and sofa corner. Angle et canapé angle. Rincón y sofá rincón.

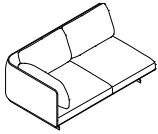

**SERRI184BSPD**

184 x 108 H82  
72.44"x 42.52" H32.28"  
IZQ.

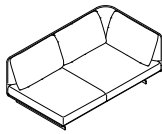

**SERRD184BSPD**

184 x 108 H82  
72.44"x 42.52" H32.28"  
DER.

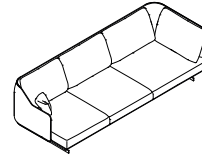

**SERSRI273BSPDBB**

273 x 108 H82  
107.48"x 42.52" H32.28"  
IZQ.

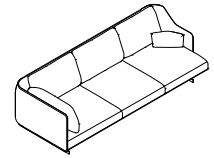

**SERSRD273BSPDBB**

273 x 108 H82  
107.48"x 42.52" H32.28"  
DER.

| MEASUREMENT. MESURE. MEDIDA.            | REF.                              | M.L. | COM / COL | 1        | 2        | 3        | 4        | 5        | L1       | L2       |
|---|-----------------------------------|------|-----------|----------|----------|----------|----------|----------|----------|----------|
| 184 x 108 H82   72.44"x 42.52" H32.28"  | SERRI184BSPD - SERRD184BSPD       | 11.5 | 2.851,24  | 2.946,28 | 3.095,04 | 3.264,46 | 3.561,98 | 4.111,57 | 4.235,54 | 4.789,26 |
| 273 x 108 H82   107.48"x 42.52" H32.28" | SERSRI273BSPDBB - SERSRD273BSPDBB | 16   | 4.008,26  | 4.140,50 | 4.376,03 | 4.611,57 | 5.095,04 | 5.933,88 | 6.119,83 | 6.958,68 |

SERENE. Ottomans. Poufs. Ottomans.



**SERP80BSPD**

80 x 104 H42  
31.50"x 40.94" H16.54"

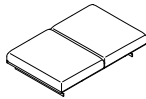

**SERP160BSPD**

160 x 104 H42  
62.99"x 40.94" H16.54"

| MEASUREMENT. MESURE. MEDIDA.           | REF.        | M.L. | COM / COL | 1        | 2        | 3        | 4        | 5        | L1       | L2       |
|--|-------------|------|-----------|----------|----------|----------|----------|----------|----------|----------|
| 80 x 104 H42   31.5"x 40.94" H16.54"   | SERP80BSPD  | 3    | 1.020,66  | 1.028,93 | 1.074,38 | 1.107,44 | 1.169,42 | 1.293,39 | 1.318,18 | 1.442,15 |
| 160 x 104 H42   62.99"x 40.94" H16.54" | SERP160BSPD | 5    | 1.632,23  | 1.677,69 | 1.747,93 | 1.801,65 | 1.958,68 | 2.185,95 | 2.239,67 | 2.483,47 |

SERENE. Chaise longues.

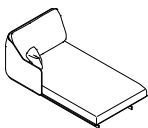

**SERCLI98BSPDBB**

98 x 170 H82  
42.52"x 66.93" H32.28"  
IZQ.



**SERCLD98BSPDBB**

98 x 170 H82  
42.52"x 66.93" H32.28"  
DER.

| MEASUREMENT. MESURE. MEDIDA.          | REF.                            | M.L. | COM / COL | 1        | 2        | 3        | 4        | 5        | L1       | L2       |
|---------------------------------------|---------------------------------|------|-----------|----------|----------|----------|----------|----------|----------|----------|
| 98 x 170 H82   38.58"x 66.93" H32.28" | SERCLI98BSPDBB - SERCLD98BSPDBB | 8    | 2.231,40  | 2.289,26 | 2.388,43 | 2.483,47 | 2.677,69 | 3.024,79 | 3.095,04 | 3.454,55 |

## SERENE.

PRICES. PRIX. PRECIOS.

SEAT CUSHION 90 CM. COUSSIN DE L'ASSISE DE 90 CM. COJÍN DE ASIENTO DE 90 CM.

SERENE. Sofas with 1 arm. Canapés avec 1 accoudoir. Sofás con 1 brazo.



**SERSI95BSPDBB**

95 x 108 H82  
37.40" x 42.52" H32.28"  
IZQ.

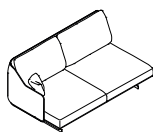

**SERSI185BSPDBB**

185 x 108 H82  
72.83" x 42.52" H32.28"  
IZQ.

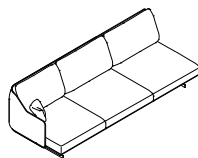

**SERSI275BSPDBB**

275 x 108 H82  
108.27" x 42.52" H32.28"  
IZQ.



**SERSD95BSPDBB**

95 x 108 H82  
37.40" x 42.52" H32.28"  
DER.

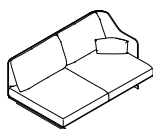

**SERSD185BSPDBB**

185 x 108 H82  
72.83" x 42.52" H32.28"  
DER.

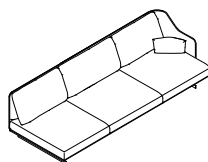

**SERSD275BSPDBB**

275 x 108 H82  
108.27" x 42.52" H32.28"  
DER.

| MEASUREMENT. MESURE. MEDIDA.             | REF.                            | M.L. | COM / COL | 1        | 2        | 3        | 4        | 5        | L1       | L2       |
|--|---------------------------------|------|-----------|----------|----------|----------|----------|----------|----------|----------|
| 95 x 108 H82   37.40" x 42.52" H32.28"   | SERSI95BSPDBB - SERSD95BSPDBB   | 8.5  | 1.793,39  | 1.842,98 | 1.929,75 | 2.000,00 | 2.169,42 | 2.458,68 | 2.528,93 | 2.805,79 |
| 185 x 108 H82   72.83" x 42.52" H32.28"  | SERSI185BSPDBB - SERSD185BSPDBB | 11.5 | 2.772,73  | 2.851,24 | 2.983,47 | 3.132,23 | 3.429,75 | 3.929,75 | 4.033,06 | 4.541,32 |
| 275 x 108 H82   108.27" x 42.52" H32.28" | SERSI275BSPDBB - SERSD275BSPDBB | 16   | 3.764,46  | 3.867,77 | 4.078,51 | 4.272,73 | 4.673,55 | 5.409,09 | 5.566,12 | 6.293,39 |

SERENE. Sofas without arms. Canapés sans accoudoirs. Sofás sin brazos.

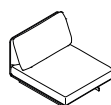

**SERS090BSPD**

90 x 108 H82  
35.43" x 42.52" H32.28"

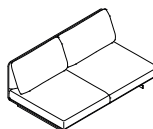

**SERS0180BSPD**

180 x 108 H82  
70.87" x 42.52" H32.28"

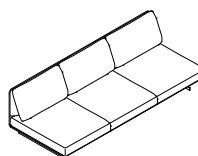

**SERS0270BSPD**

270 x 108 H82  
106.30" x 42.52" H32.28"

| MEASUREMENT. MESURE. MEDIDA.             | REF.         | M.L. | COM / COL | 1        | 2        | 3        | 4        | 5        | L1       | L2       |
|--|--------------|------|-----------|----------|----------|----------|----------|----------|----------|----------|
| 90 X 108 H82   35.43" x 42.52" H32.28"   | SERS090BSPD  | 7.5  | 1.644,63  | 1.677,69 | 1.747,93 | 1.801,65 | 1.950,41 | 2.177,69 | 2.231,40 | 2.466,94 |
| 180 x 108 H82   70.87" x 42.52" H32.28"  | SERS0180BSPD | 11   | 2.586,78  | 2.657,02 | 2.780,99 | 2.913,22 | 3.148,76 | 3.595,04 | 3.681,82 | 4.132,23 |
| 270 x 108 H82   106.30" x 42.52" H32.28" | SERS0270BSPD | 15.5 | 3.570,25  | 3.673,55 | 3.859,50 | 4.041,32 | 4.421,49 | 5.078,51 | 5.243,80 | 5.884,30 |

SERENE.

PRICES. PRIX. PRECIOS.

SEAT CUSHION 90 CM. COUSSIN DE L'ASSISE DE 90 CM. COJÍN DE ASIENTO DE 90 CM.

SERENE. Corner and sofa corner. Angle et canapé angle. Rincón y sofá rincón.

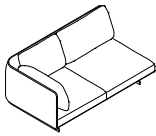

**SERRI194BSPD**

194 x 108 H82  
76.38" x 42.52" H32.28"  
IZQ.



**SERRD194BSPD**

194 x 108 H82  
76.38" x 42.52" H32.28"  
DER.

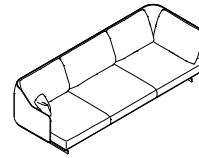

**SERSRI293BSPDBB**

293 x 108 H82  
115.35" x 42.52" H32.28"  
IZQ.

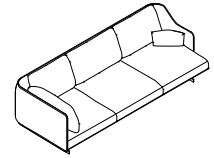

**SERSRD293BSPDBB**

293 x 108 H82  
115.35" x 42.52" H32.28"  
DER.

| MEASUREMENT. MESURE. MEDIDA.             | REF.                              | M.L. | COM / COL | 1        | 2        | 3        | 4        | 5        | L1       | L2       |
|--|-----------------------------------|------|-----------|----------|----------|----------|----------|----------|----------|----------|
| 194 x 108 H82   76.38" x 42.52" H32.28"  | SERRI194BSPD - SERRD194BSPD       | 11.5 | 2.851,24  | 2.946,28 | 3.095,04 | 3.264,46 | 3.561,98 | 4.111,57 | 4.235,54 | 4.789,26 |
| 293 x 108 H82   115.35" x 42.52" H32.28" | SERSRI293BSPDBB - SERSRD293BSPDBB | 16.5 | 4.243,80  | 4.376,03 | 4.628,10 | 4.859,50 | 5.330,58 | 6.190,08 | 6.371,90 | 7.239,67 |

SERENE. Ottomans. Poufs. Ottomans.

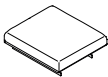

**SERP90BSPD**

90 x 104 H42  
35.43" x 40.94" H16.54"

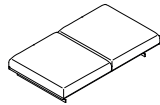

**SERP180BSPD**

180 x 104 H42  
70.87" x 40.94" H16.54"

| MEASUREMENT. MESURE. MEDIDA.            | REF.        | M.L. | COM / COL | 1        | 2        | 3        | 4        | 5        | L1       | L2       |
|---|-------------|------|-----------|----------|----------|----------|----------|----------|----------|----------|
| 90 x 104 H42   35.43" x 40.94" H16.54"  | SERP90BSPD  | 3    | 1.082,64  | 1.107,44 | 1.144,63 | 1.177,69 | 1.272,73 | 1.421,49 | 1.458,68 | 1.607,44 |
| 180 x 104 H42   70.87" x 40.94" H16.54" | SERP180BSPD | 5    | 1.739,67  | 1.772,73 | 1.851,24 | 1.929,75 | 2.082,64 | 2.334,71 | 2.404,96 | 2.657,02 |

SERENE. Chaise longues.

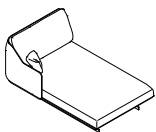

**SERCLI108BSPDBB**

108 x 170 H82  
42.52" x 32.28" H32.28"  
IZQ.

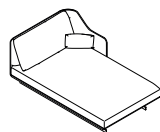

**SERCLD108BSPDBB**

108 x 170 H82  
42.52" x 32.28" H32.28"  
DER.

| MEASUREMENT. MESURE. MEDIDA.            | REF.                              | M.L. | COM / COL | 1        | 2        | 3        | 4        | 5        | L1       | L2       |
|---|-----------------------------------|------|-----------|----------|----------|----------|----------|----------|----------|----------|
| 108 x 170 H82   42.52" x 32.28" H32.28" | SERCLI108BSPDBB - SERCLD108BSPDBB | 8    | 2.318,18  | 2.388,43 | 2.475,21 | 2.578,51 | 2.764,46 | 3.115,70 | 3.202,48 | 3.553,72 |

# SERENE.

# SOFA. CANAPÉ. SOFÁ.



Designer  
Mario Ruiz

STYLE. ESTILO.  
Singular

VERSION. VERSIÓN.  
Floor standing. Ras du sol. Base a suelo.

VARIANTS. VARIANTES.  
Standard depth. Profondeur standard. Profundidad estándar. (98 cm - 38.58 in)  
High arm. Accoudoir haut. Brazo alto.

## FEATURES. TRAITS. CARACTERÍSTICAS.

**The high backrest costs an extra 47 euros per unit. Le dossier haut coûte 47 euros de plus par unité. El respaldo alto tiene un coste extra de 47 euros por unidad.**

Removable upholstery in back and auxiliary cushions.

Wooden frame covered with flexible cold shaped polyurethane foam and polyester fibre.

Suspension consisting of fibreglass reinforced plastic slats.

Seats in different polyurethane foam densities, with surface padding in fibre. Back cushions stuffed with polyester fibre and washed, sterilised down. Auxiliary cushions stuffed with polyester fibre and washed, sterilised down.

LDPE feet.

Two back cushions heights available: Standard (82 cm - 32.28 in) or High (92 cm - 36.22)

Tapiserie déhoussable sur les coussins du dossier et coussins auxiliaires.

Cadre en bois recouvert de mousse de polyuréthane souple à froid et de fibre de polyester.

Suspension au moyen de lattes renforcées avec de la fibre de verre.

Assise réalisé dans différentes densités de mousse polyuréthane, matelassé en surface avec du fibre. Coussins du dossier garnis de fibre de polyester et plumes lavées et stérilisées. Coussins auxiliaires garnis de fibre de polyester et plumes lavées et stérilisées.

Pieds en PEBD.

Deux hauteurs de coussin pour les dossiers disponibles : Standard (82 cm) ou Haut (92 cm)

Tapicería desenfundable en cojines de respaldo y cojines auxiliares.

Bastidor de madera recubierto de espuma de poliuretano flexible en frío y fibra de poliéster.

Suspensión mediante lamas de plástico reforzadas con fibra de vidrio.

Asientos realizados en distintas densidades de espuma de poliuretano, acolchados en la superficie con fibra. Cojines de respaldo rellenos de fibra de poliéster y pluma lavada y esterilizada. Cojines auxiliares rellenos de fibra de poliéster y pluma lavada y esterilizada.

Patas en LDPE.

Dos alturas de respaldo disponibles: Estándar (82 cm) o Alto (92 cm)



## SERENE.

### GENERAL MEASUREMENTS. MESURES GÉNÉRALES. MEDIDAS GENERALES.

---

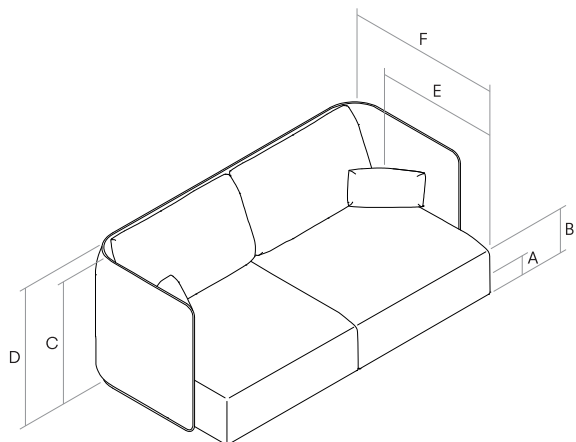

- A. Base height. Hauteur de base. Altura de base. 5 cm - 1.97"
- B. Seat height. Hauteur du siège. Altura de asiento. 42 cm - 16.54"
- C. Arm height. Hauteur du bras. Altura de brazo. 77 cm - 30.31"
- D. Backrest height. Hauteur du dossier. Altura de respaldo. 82 cm - 32.28"
- E. Seat depth. Profondeur d'assise. Profundidad de sentada. 58 cm - 22.83"
- F. Depth. Profondeur. Profundidad. 98 cm - 38.58"

### FINISHES. TRAITS. ACABADOS.

---

Finishes for the feet. Finitions des pieds. Acabados de las patas.

---

Low density polyethylene. Polyéthylène basse densité. Polietileno de baja densidad.

---



LDPE  
PEBD

### OPTIONAL BACK CUSHIONS. COUSSINS DU DOSSIER EN OPTION. COJINES DE RESPALDO OPCIONALES.

---

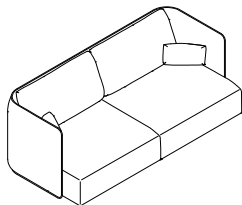

Standard option. Option standard. Opción estándar.  
Backrest height. Hauteur du dossier. Altura de respaldo.  
**82 cm - 32.28"**

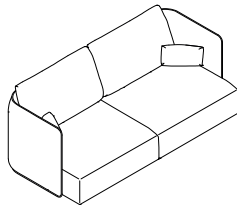

Premium option. Option premium. Opción premium.  
Backrest height. Hauteur du dossier. Altura de respaldo.  
**92 cm - 36.22"**

## SERENE.

### FINISHES. TRAITS. ACABADOS.

Wood finishes. Finitions bois. Acabado de la madera.



**RN**  
Natural oak.  
Chêne naturel.  
Roble natural.



**NA**  
Natural american walnut.  
Noyer américain.  
Nogal americano.



**RT**  
Dark stained oak.  
Chêne teint foncée.  
Roble teñido oscuro.



**RL**  
Oak painted in black with open-pore finish.  
Chêne laqué noir à pores ouverts.  
Roble lacado negro por abierto.

Lacquered. Laqué. Lacados.



SEDA



ALOE



KHAKI



BRICK



RUBI



KOKOA

## CONFIGURATOR.

Compatibility between furniture and upholstered elements. Compatibilité entre les meubles et les éléments tapissés. Compatibilidad entre mobiliario y elementos tapizados.

|  | REFERENCE.      | Supported references. Références compatibles. Referencias compatibles. |                                   |              |
|--|-----------------|--|-----------------------------------|--------------|
|  | <b>SERMU149</b> | SERS170BTPSBA  | SERSI165BTPSBA - SERSD165BTPSBA   | SERS0160BTPS |
|  | <b>SERMU169</b> | SERS190BTPSBA  | SERSI185BTPSBA - SERSD185BTPSBA   | SERS0180BTPS |
|  | <b>SERMU189</b> | SERS210BTPSBA  |                                   |              |
|  | <b>SERMU209</b> | SERS230BTPSBA  |                                   |              |
|  | <b>SERMU229</b> | SERS250BTPSBA  | SERSI245BTPSBA - SERSD245BTPSBA   | SERS0240BTPS |
|  | <b>SERMU162</b> | SERRI174BTPS - SERRD174BTPS  | SERSRI263BTPSBA - SERSRD263BTPSBA |              |
|  | <b>SERMU172</b> | SERRI184BTPS - SERRD184BTPS  | SERSRI283BTPSBA - SERSRD283BTPSBA |              |
|  | <b>SERMU83</b>  | SERCLI98BTPSBA - SERCLD98BTPSBA  |                                   |              |
|  | <b>SERMU93</b>  | SERCLI108BTPSBA - SERCLD108BTPSBA                                      |                                   |              |

## SERENE.

PRICES. PRIX. PRECIOS.

SERENE. Sofa. Canapé. Sofá.

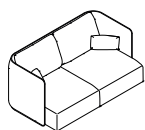

**SERS170BTPSBA**

170 x 98 H82  
66.93" x 38.58" H32.28"

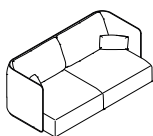

**SERS190BTPSBA**

190 x 98 H82  
74.80" x 38.58" H32.28"

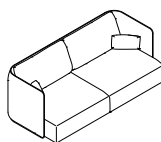

**SERS210BTPSBA**

210 x 98 H82  
82.68" x 38.58" H32.28"

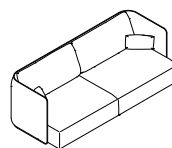

**SERS230BTPSBA**

230 x 98 H82  
90.55" x 38.58" H32.28"

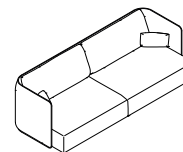

**SERS250BTPSBA**

250 x 98 H82  
98.43" x 38.58" H32.28"

| MEASUREMENT. MESURE. MEDIDA.           | REF.          | M.L. | COM / COL | 1        | 2        | 3        | 4        | 5        | L1       | L2       |
|--|---------------|------|-----------|----------|----------|----------|----------|----------|----------|----------|
| 170 x 98 H82   66.93" x 38.58" H32.28" | SERS170BTPSBA | 12   | 2.148,76  | 2.247,93 | 2.413,22 | 2.561,98 | 2.859,50 | 3.429,75 | 3.545,45 | 4.111,57 |
| 190 x 98 H82   74.80" x 38.58" H32.28" | SERS190BTPSBA | 12   | 2.326,45  | 2.429,75 | 2.570,25 | 2.727,27 | 3.037,19 | 3.595,04 | 3.735,54 | 4.272,73 |
| 210 x 98 H82   82.68" x 38.58" H32.28" | SERS210BTPSBA | 13   | 2.438,02  | 2.528,93 | 2.685,95 | 2.842,98 | 3.157,02 | 3.735,54 | 3.851,24 | 4.421,49 |
| 230 x 98 H82   90.55" x 38.58" H32.28" | SERS230BTPSBA | 13.5 | 2.623,97  | 2.727,27 | 2.896,69 | 3.045,45 | 3.367,77 | 3.954,55 | 4.095,04 | 4.665,29 |
| 250 x 98 H82   98.43" x 38.58" H32.28" | SERS250BTPSBA | 13.5 | 2.805,79  | 2.896,69 | 3.061,98 | 3.235,54 | 3.545,45 | 4.140,50 | 4.272,73 | 4.859,50 |

SERENE.

PRICES. PRIX. PRECIOS.

SERENE. Furniture for sofas, sofas with 1 arm, and without arms. Meubles pour canapés, canapés avec 1 accoudoir et sans accoudoirs. Muebles para sofás, para sofás con 1 brazo y para sofás sin brazos.



**SERMU149**

149 x 25 H43  
63.78" x 9.84" H16.93"



**SERMU169**

169 x 25 H43  
66.54" x 9.84" H16.93"

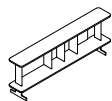

**SERMU189**

189 x 25 H43  
74.41" x 9.84" H16.93"

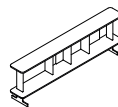

**SERMU209**

209 x 25 H43  
82.28" x 9.84" H16.93"

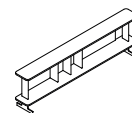

**SERMU229**

229 x 25 H43  
90.16" x 9.84" H16.93"

| MEASUREMENT. MESURE. MEDIDA.          | FINISHES. TRAITS. ACABADOS.   | REF.       | PRICE. PRIX. PRECIO. |
|---------------------------------------|---|------------|----------------------|
| 149 x 25 H43   63.78" x 9.84" H16.93" | Natural oak. Chêne naturel. Roble natural.  | SERMU149RN | 1.161,16             |
| 149 x 25 H43   63.78" x 9.84" H16.93" | American walnut. Noyer américain. Nogal americano.  | SERMU149NA | 1.256,20             |
| 149 x 25 H43   63.78" x 9.84" H16.93" | Dark stained oak. Chêne teinté foncé. Roble teñido oscuro.  | SERMU149RT | 1.161,16             |
| 149 x 25 H43   63.78" x 9.84" H16.93" | Oak painted in black with open-pore finish. Chêne laqué noir à pores ouverts. Roble lacado negro por abierto. | SERMU149RL | 1.256,20             |
| 149 x 25 H43   63.78" x 9.84" H16.93" | Matt lacquer. Laque mate. Lacado mate.  | SERMU149LA | 1.161,16             |
| 169 x 25 H43   66.54" x 9.84" H16.93" | Natural oak. Chêne naturel. Roble natural.  | SERMU169RN | 1.235,54             |
| 169 x 25 H43   66.54" x 9.84" H16.93" | American walnut. Noyer américain. Nogal americano.  | SERMU169NA | 1.342,98             |
| 169 x 25 H43   66.54" x 9.84" H16.93" | Dark stained oak. Chêne teinté foncé. Roble teñido oscuro.  | SERMU169RT | 1.235,54             |
| 169 x 25 H43   66.54" x 9.84" H16.93" | Oak painted in black with open-pore finish. Chêne laqué noir à pores ouverts. Roble lacado negro por abierto. | SERMU169RL | 1.342,98             |
| 169 x 25 H43   66.54" x 9.84" H16.93" | Matt lacquer. Laque mate. Lacado mate.  | SERMU169LA | 1.235,54             |
| 189 x 25 H43   74.41" x 9.84" H16.93" | Natural oak. Chêne naturel. Roble natural.  | SERMU189RN | 1.355,37             |
| 189 x 25 H43   74.41" x 9.84" H16.93" | American walnut. Noyer américain. Nogal americano.  | SERMU189NA | 1.442,15             |
| 189 x 25 H43   74.41" x 9.84" H16.93" | Dark stained oak. Chêne teinté foncé. Roble teñido oscuro.  | SERMU189RT | 1.322,31             |
| 189 x 25 H43   74.41" x 9.84" H16.93" | Oak painted in black with open-pore finish. Chêne laqué noir à pores ouverts. Roble lacado negro por abierto. | SERMU189RL | 1.442,15             |
| 189 x 25 H43   74.41" x 9.84" H16.93" | Matt lacquer. Laque mate. Lacado mate.  | SERMU189LA | 1.322,31             |
| 209 x 25 H43   82.28" x 9.84" H16.93" | Natural oak. Chêne naturel. Roble natural.  | SERMU209RN | 1.396,69             |
| 209 x 25 H43   82.28" x 9.84" H16.93" | American walnut. Noyer américain. Nogal americano.  | SERMU209NA | 1.495,87             |
| 209 x 25 H43   82.28" x 9.84" H16.93" | Dark stained oak. Chêne teinté foncé. Roble teñido oscuro.  | SERMU209RT | 1.396,69             |
| 209 x 25 H43   82.28" x 9.84" H16.93" | Oak painted in black with open-pore finish. Chêne laqué noir à pores ouverts. Roble lacado negro por abierto. | SERMU209RL | 1.495,87             |
| 209 x 25 H43   82.28" x 9.84" H16.93" | Matt lacquer. Laque mate. Lacado mate.  | SERMU209LA | 1.396,69             |
| 229 x 25 H43   90.16" x 9.84" H16.93" | Natural oak. Chêne naturel. Roble natural.  | SERMU229RN | 1.508,26             |
| 229 x 25 H43   90.16" x 9.84" H16.93" | American walnut. Noyer américain. Nogal americano.  | SERMU229NA | 1.603,31             |
| 229 x 25 H43   90.16" x 9.84" H16.93" | Dark stained oak. Chêne teinté foncé. Roble teñido oscuro.  | SERMU229RT | 1.508,26             |
| 229 x 25 H43   90.16" x 9.84" H16.93" | Oak painted in black with open-pore finish. Chêne laqué noir à pores ouverts. Roble lacado negro por abierto. | SERMU229RL | 1.603,31             |
| 229 x 25 H43   90.16" x 9.84" H16.93" | Matt lacquer. Laque mate. Lacado mate.  | SERMU229LA | 1.508,26             |

## SERENE.

### PRICES. PRIX. PRECIOS.

SERENE. Furniture for chaise longue. Meubles pour chaise longue. Muebles para chaise longue.



#### SERMU83

83 x 25 H43  
32.68" x 9.84" H16.93"



#### SERMU93

93 x 25 H43  
36.61" x 9.84" H16.93"

| MEASUREMENT. MESURE. MEDIDA.         | FINISHES. TRAITS. ACABADOS.   | REF.      | PRICE. PRIX. PRECIO. |
|--------------------------------------|---|-----------|----------------------|
| 83 x 25 H43   32.68" x 9.84" H16.93" | Natural oak. Chêne naturel. Roble natural.  | SERMU83RN | 954,55               |
| 83 x 25 H43   32.68" x 9.84" H16.93" | American walnut. Noyer américain. Nogal americano.  | SERMU83NA | 1.020,66             |
| 83 x 25 H43   32.68" x 9.84" H16.93" | Dark stained oak. Chêne teinté foncé. Roble teñido oscuro.  | SERMU83RT | 954,55               |
| 83 x 25 H43   32.68" x 9.84" H16.93" | Oak painted in black with open-pore finish. Chêne laqué noir à pores ouverts. Roble lacado negro por abierto. | SERMU83RL | 1.020,66             |
| 83 x 25 H43   32.68" x 9.84" H16.93" | Matt lacquer. Laque mate. Lacado mate.  | SERMU83LA | 954,55               |
| 93 x 25 H43   36.61" x 9.84" H16.93" | Natural oak. Chêne naturel. Roble natural.  | SERMU93RN | 987,60               |
| 93 x 25 H43   36.61" x 9.84" H16.93" | American walnut. Noyer américain. Nogal americano.  | SERMU93NA | 1.041,32             |
| 93 x 25 H43   36.61" x 9.84" H16.93" | Dark stained oak. Chêne teinté foncé. Roble teñido oscuro.  | SERMU93RT | 987,60               |
| 93 x 25 H43   36.61" x 9.84" H16.93" | Oak painted in black with open-pore finish. Chêne laqué noir à pores ouverts. Roble lacado negro por abierto. | SERMU93RL | 1.041,32             |
| 93 x 25 H43   36.61" x 9.84" H16.93" | Matt lacquer. Laque mate. Lacado mate.  | SERMU93LA | 987,60               |

SERENE. Furniture for corner and sofa corner. Meubles pour angle et canapé angle. Muebles para rincón y sofá rincón.



#### SERMU162

162 x 25 H43  
63.78" x 9.84" H16.93"

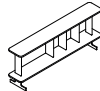

#### SERMU172

172 x 25 H43  
67.72" x 9.84" H16.93"

| MEASUREMENT. MESURE. MEDIDA.          | FINISHES. TRAITS. ACABADOS.   | REF.       | PRICE. PRIX. PRECIO. |
|---------------------------------------|---|------------|----------------------|
| 162 x 25 H43   63.78" x 9.84" H16.93" | Natural oak. Chêne naturel. Roble natural.  | SERMU162RN | 1.214,88             |
| 162 x 25 H43   63.78" x 9.84" H16.93" | American walnut. Noyer américain. Nogal americano.  | SERMU162NA | 1.314,05             |
| 162 x 25 H43   63.78" x 9.84" H16.93" | Dark stained oak. Chêne teinté foncé. Roble teñido oscuro.  | SERMU162RT | 1.214,88             |
| 162 x 25 H43   63.78" x 9.84" H16.93" | Oak painted in black with open-pore finish. Chêne laqué noir à pores ouverts. Roble lacado negro por abierto. | SERMU162RL | 1.314,05             |
| 162 x 25 H43   63.78" x 9.84" H16.93" | Matt lacquer. Laque mate. Lacado mate.  | SERMU162LA | 1.214,88             |
| 172 x 25 H43   67.72" x 9.84" H16.93" | Natural oak. Chêne naturel. Roble natural.  | SERMU172RN | 1.293,39             |
| 172 x 25 H43   67.72" x 9.84" H16.93" | American walnut. Noyer américain. Nogal americano.  | SERMU172NA | 1.421,49             |
| 172 x 25 H43   67.72" x 9.84" H16.93" | Dark stained oak. Chêne teinté foncé. Roble teñido oscuro.  | SERMU172RT | 1.293,39             |
| 172 x 25 H43   67.72" x 9.84" H16.93" | Oak painted in black with open-pore finish. Chêne laqué noir à pores ouverts. Roble lacado negro por abierto. | SERMU172RL | 1.421,49             |
| 172 x 25 H43   67.72" x 9.84" H16.93" | Matt lacquer. Laque mate. Lacado mate.  | SERMU172LA | 1.293,39             |

SERENE.

PRICES. PRIX. PRECIOS.

SEAT CUSHION 80 CM. COUSSIN DE L'ASSISE DE 80 CM. COJÍN DE ASIENTO DE 80 CM.

SERENE. Sofas with 1 arm. Canapés avec 1 accoudoir. Sofás con 1 brazo.

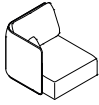

**SERSI85BTSPBA**

85 x 98 H82  
33.46" x 38.58" H32.28"  
IZQ.

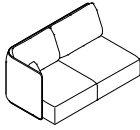

**SERSI165BTSPBA**

165 x 98 H82  
64.96" x 38.58" H32.28"  
IZQ.

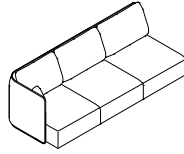

**SERSI245BTSPBA**

245 x 98 H82  
96.46" x 38.58" H32.28"  
IZQ.

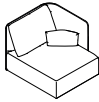

**SERSD85BTSPBA**

85 x 98 H82  
33.46" x 38.58" H32.28"  
DER.

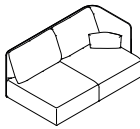

**SERSD165BTSPBA**

165 x 98 H82  
64.96" x 38.58" H32.28"  
DER.

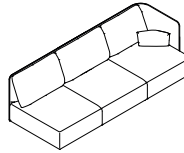

**SERSD245BTSPBA**

245 x 98 H82  
96.46" x 38.58" H32.28"  
DER.

| MEASUREMENT. MESURE. MEDIDA.           | REF.                            | M.L. | COM / COL | 1        | 2        | 3        | 4        | 5        | L1       | L2       |
|--|---------------------------------|------|-----------|----------|----------|----------|----------|----------|----------|----------|
| 85 x 98 H82   33.46" x 38.58" H32.28"  | SERSI85BTSPBA - SERSD85BTSPBA   | 7    | 1.326,45  | 1.388,43 | 1.466,94 | 1.528,93 | 1.702,48 | 1.983,47 | 2.037,19 | 2.326,45 |
| 165 x 98 H82   64.96" x 38.58" H32.28" | SERSI165BTSPBA - SERSD165BTSPBA | 10   | 1.991,74  | 2.090,91 | 2.231,40 | 2.351,24 | 2.623,97 | 3.132,23 | 3.235,54 | 3.735,54 |
| 245 x 98 H82   96.46" x 38.58" H32.28" | SERSI245BTSPBA - SERSD245BTSPBA | 15   | 2.805,79  | 2.913,22 | 3.132,23 | 3.280,99 | 3.657,02 | 4.330,58 | 4.479,34 | 5.157,02 |

SERENE. Sofas without arms. Canapés sans accoudoirs. Sofás sin brazos.

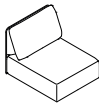

**SERS080BTSPS**

80 x 98 H82  
31.50" x 38.58" H32.28"

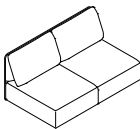

**SERS0160BTSPS**

160 x 98 H82  
62.99" x 38.58" H32.28"

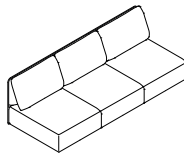

**SERS0240BTSPS**

240 x 98 H82  
94.49" x 38.58" H32.28"

| MEASUREMENT. MESURE. MEDIDA.           | REF.          | M.L. | COM / COL | 1        | 2        | 3        | 4        | 5        | L1       | L2       |
|--|---------------|------|-----------|----------|----------|----------|----------|----------|----------|----------|
| 80 X 98 H82   31.50" x 42.52" H32.28"  | SERS080BTSPS  | 6    | 1.136,36  | 1.169,42 | 1.231,40 | 1.285,12 | 1.404,96 | 1.623,97 | 1.661,16 | 1.888,43 |
| 160 x 98 H82   62.99" x 42.52" H32.28" | SERS0160BTSPS | 9.5  | 1.780,99  | 1.842,98 | 1.966,94 | 2.090,91 | 2.309,92 | 2.727,27 | 2.826,45 | 3.243,80 |
| 240 x 98 H82   94.49" x 42.52" H32.28" | SERS0240BTSPS | 14.5 | 2.561,98  | 2.657,02 | 2.826,45 | 3.000,00 | 3.326,45 | 3.946,28 | 4.086,78 | 4.681,82 |

SERENE.

PRICES. PRIX. PRECIOS.

SEAT CUSHION 80 CM. COUSSIN DE L'ASSISE DE 80 CM. COJÍN DE ASIENTO DE 80 CM.

SERENE. Corner and sofa corner. Angle et canapé angle. Rincón y sofá rincón.

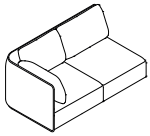

**SERRI174BTPS**

174 x 98 H82  
68.50" x 38.58" H32.28"  
IZQ.

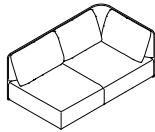

**SERRD174BTPS**

174 x 98 H82  
68.50" x 38.58" H32.28"  
DER.

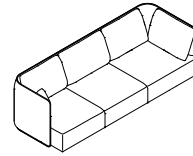

**SERSRI263BTPSBA**

263 x 98 H82  
103.54" x 38.58" H32.28"  
IZQ.

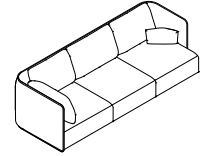

**SERSRD263BTPSBA**

263 x 98 H82  
103.54" x 38.58" H32.28"  
DER.

| MEASUREMENT. MESURE. MEDIDA.            | REF.                              | M.L. | COM / COL | 1        | 2        | 3        | 4        | 5        | L1       | L2       |
|---|-----------------------------------|------|-----------|----------|----------|----------|----------|----------|----------|----------|
| 174 x 98 H82   68.50" x 38.58" H32.28"  | SERRI174BTPS - SERRD174BTPS       | 11   | 2.202,48  | 2.297,52 | 2.450,41 | 2.599,17 | 2.896,69 | 3.429,75 | 3.545,45 | 4.086,78 |
| 263 x 98 H82   103.54" x 38.58" H32.28" | SERSRI263BTPSBA - SERSRD263BTPSBA | 15.5 | 3.024,79  | 3.157,02 | 3.376,03 | 3.611,57 | 4.070,25 | 4.867,77 | 5.041,32 | 5.863,64 |

SERENE. Ottomans. Poufs. Ottomans.



**SERP80BTPS**

80 x 94 H42  
31.50" x 37.01" H16.54"

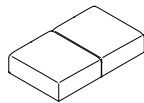

**SERP160BTPS**

160 x 94 H42  
62.99" x 37.01" H16.54"

| MEASUREMENT. MESURE. MEDIDA.           | REF.        | M.L. | COM / COL | 1        | 2        | 3        | 4        | 5        | L1       | L2       |
|--|-------------|------|-----------|----------|----------|----------|----------|----------|----------|----------|
| 80 x 94 H42   31.50" x 37.01" H16.54"  | SERP80BTPS  | 2.5  | 590,91    | 615,70   | 644,63   | 669,42   | 731,40   | 747,93   | 855,37   | 983,47   |
| 160 x 94 H42   62.99" x 37.01" H16.54" | SERP160BTPS | 4.5  | 1.053,72  | 1.082,64 | 1.136,36 | 1.177,69 | 1.285,12 | 1.466,94 | 1.504,13 | 1.677,69 |

SERENE. Chaise longues.

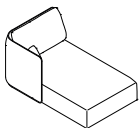

**SERCLI98BTPSBA**

98 x 160 H82  
38.58" x 62.99" H32.28"  
IZQ.

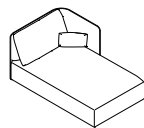

**SERCLD98BTPSBA**

98 x 160 H82  
38.58" x 62.99" H32.28"  
DER.

| MEASUREMENT. MESURE. MEDIDA.           | REF.                            | M.L. | COM / COL | 1        | 2        | 3        | 4        | 5        | L1       | L2       |
|--|---------------------------------|------|-----------|----------|----------|----------|----------|----------|----------|----------|
| 98 x 160 H82   38.58" x 62.99" H32.28" | SERCLI98BTPSBA - SERCLD98BTPSBA | 7.5  | 1.756,20  | 1.801,65 | 1.896,69 | 1.983,47 | 2.169,42 | 2.491,74 | 2.570,25 | 2.896,69 |

SERENE.

PRICES. PRIX. PRECIOS.

SEAT CUSHION 90 CM. COUSSIN DE L'ASSISE DE 90 CM. COJÍN DE ASIENTO DE 90 CM.

SERENE. Sofas with 1 arm. Canapés avec 1 accoudoir. Sofás con 1 brazo.

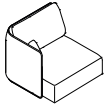

**SERSI95BTPSBA**

95 x 98 H82  
37.40" x 38.58" H32.28"  
IZQ.

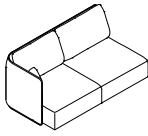

**SERSI185BTPSBA**

185 x 98 H82  
72.83" x 38.58" H32.28"  
IZQ.

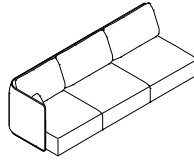

**SERSI275BTPSBA**

275 x 98 H82  
108.27" x 38.58" H32.28"  
IZQ.

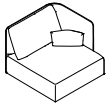

**SERSD95BTPSBA**

95 x 98 H82  
37.40" x 38.58" H32.28"  
DER.

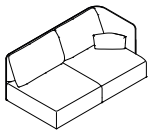

**SERSD185BTPSBA**

185 x 98 H82  
72.83" x 38.58" H32.28"  
DER.

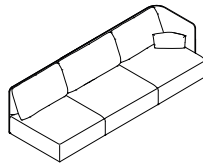

**SERSD275BTPSBA**

275 x 98 H82  
108.27" x 38.58" H32.28"  
DER.

| MEASUREMENT. MESURE. MEDIDA.            | REF.                            | M.L. | COM / COL | 1        | 2        | 3        | 4        | 5        | L1       | L2       |
|---|---------------------------------|------|-----------|----------|----------|----------|----------|----------|----------|----------|
| 95 x 98 H82   37.40" x 38.58" H32.28"   | SERSI95BTPSBA - SERSD95BTPSBA   | 8    | 1.421,49  | 1.466,94 | 1.537,19 | 1.623,97 | 1.780,99 | 2.090,91 | 2.140,50 | 2.438,02 |
| 185 x 98 H82   72.83" x 38.58" H32.28"  | SERSI185BTPSBA - SERSD185BTPSBA | 11   | 2.185,95  | 2.264,46 | 2.413,22 | 2.545,45 | 2.826,45 | 3.305,79 | 3.429,75 | 3.913,22 |
| 275 x 98 H82   108.27" x 38.58" H32.28" | SERSI275BTPSBA - SERSD275BTPSBA | 15.5 | 3.024,79  | 3.148,76 | 3.334,71 | 3.533,06 | 3.929,75 | 4.628,10 | 4.789,26 | 5.487,60 |

SERENE. Sofas without arms. Canapés sans accoudoirs. Sofás sin brazo.

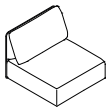

**SERS090BTPS**

90 x 98 H82  
35.43" x 38.58" H32.28"

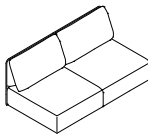

**SERS0180BTPS**

180 x 98 H82  
70.87" x 38.58" H32.28"

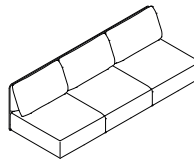

**SERS0270BTPS**

270 x 98 H82  
106.30" x 38.58" H32.28"

| MEASUREMENT. MESURE. MEDIDA.            | REF.         | M.L. | COM / COL | 1        | 2        | 3        | 4        | 5        | L1       | L2       |
|---|--------------|------|-----------|----------|----------|----------|----------|----------|----------|----------|
| 90 X 98 H82   35.43" x 42.52" H32.28"   | SERS090BTPS  | 7.5  | 1.239,67  | 1.285,12 | 1.355,37 | 1.421,49 | 1.561,98 | 1.834,71 | 1.888,43 | 2.148,76 |
| 180 x 98 H82   70.87" x 42.52" H32.28"  | SERS0180BTPS | 11   | 2.000,00  | 2.082,64 | 2.202,48 | 2.326,45 | 2.561,98 | 2.975,21 | 3.078,51 | 3.508,26 |
| 270 x 98 H82   106.30" x 42.52" H32.28" | SERS0270BTPS | 15.5 | 2.805,79  | 2.913,22 | 3.086,78 | 3.264,46 | 3.615,70 | 4.243,80 | 4.376,03 | 5.016,53 |



## SERENE.

PRICES. PRIX. PRECIOS.

SEAT CUSHION 90 CM. COUSSIN DE L'ASSISE DE 90 CM. COJÍN DE ASIENTO DE 90 CM.

SERENE. Corner and sofa corner. Angle et canapé angle. Rincón y sofá rincón.

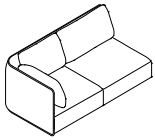

**SERRI184BTPS**

184 x 98 H82  
72.44" x 38.58" H32.28"  
IZQ.

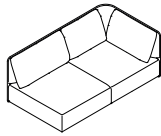

**SERRD184BTPS**

184 x 98 H82  
72.44" x 38.58" H32.28"  
DER.

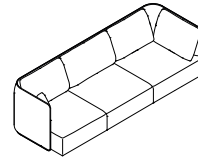

**SERSRI283BTPSBA**

283 x 98 H82  
111.42" x 38.58" H32.28"  
IZQ.

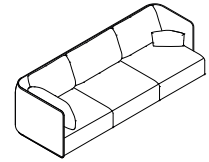

**SERSRD283BTPSBA**

283 x 98 H82  
111.42" x 38.58" H32.28"  
DER.

| MEASUREMENT. MESURE. MEDIDA.            | REF.                              | M.L. | COM / COL | 1        | 2        | 3        | 4        | 5        | L1       | L2       |
|---|-----------------------------------|------|-----------|----------|----------|----------|----------|----------|----------|----------|
| 184 x 98 H82   72.44" x 38.58" H32.28"  | SERRI184BTPS - SERRD184BTPS       | 11   | 2.309,92  | 2.404,96 | 2.561,98 | 2.694,21 | 3.000,00 | 3.533,06 | 3.657,02 | 4.210,74 |
| 283 x 98 H82   111.42" x 38.58" H32.28" | SERSRI283BTPSBA - SERSRD283BTPSBA | 16   | 3.235,54  | 3.359,50 | 3.586,78 | 3.805,79 | 4.260,33 | 5.078,51 | 5.260,33 | 6.082,64 |

SERENE. Ottomans. Poufs. Ottomans.

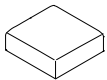

**SERP90BTPS**

90 x 94 H42  
35.43" x 37.01" H16.54"

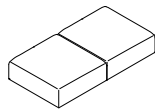

**SERP180BTPS**

180 x 94 H42  
70.87" x 37.01" H16.54"

| MEASUREMENT. MESURE. MEDIDA.           | REF.        | M.L. | COM / COL | 1        | 2        | 3        | 4        | 5        | L1       | L2       |
|--|-------------|------|-----------|----------|----------|----------|----------|----------|----------|----------|
| 90 x 94 H42   35.43" x 37.01" H16.54"  | SERP90BTPS  | 3    | 636,36    | 652,89   | 677,69   | 723,14   | 776,86   | 888,43   | 904,96   | 1.020,66 |
| 180 x 94 H42   70.87" x 37.01" H16.54" | SERP180BTPS | 5    | 1.169,42  | 1.194,21 | 1.256,20 | 1.318,18 | 1.421,49 | 1.599,17 | 1.644,63 | 1.834,71 |

SERENE. Chaise longues.

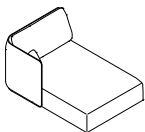

**SERCLI108BTPSBA**

108 x 160 H82  
42.52" x 62.99" H32.28"  
IZQ.

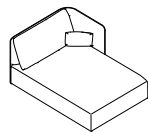

**SERCLD108BTPSBA**

108 x 160 H82  
42.52" x 62.99" H32.28"  
DER.

| MEASUREMENT. MESURE. MEDIDA.            | REF.                              | M.L. | COM / COL | 1        | 2        | 3        | 4        | 5        | L1       | L2       |
|---|-----------------------------------|------|-----------|----------|----------|----------|----------|----------|----------|----------|
| 108 x 160 H82   42.52" x 62.99" H32.28" | SERCLI108BTPSBA - SERCLD108BTPSBA | 7.5  | 1.859,50  | 1.929,75 | 2.020,66 | 2.123,97 | 2.326,45 | 2.677,69 | 2.764,46 | 3.115,70 |

# SERENE.

# SOFA. CANAPÉ. SOFÁ.



Designer  
Mario Ruiz

STYLE. ESTILO.  
Singular

VERSION. VERSIÓN.  
Floor standing. Ras du sol. Base a suelo.

VARIANTS. VARIANTES.  
Standard depth. Profondeur standard. Profundidad estándar. (98 cm - 38.58 in)  
Low arm. Accoudoir bas. Brazo bajo.

## FEATURES. TRAITS. CARACTERÍSTICAS.

**The high backrest costs an extra 47 euros per unit. Le dossier haut coûte 47 euros de plus par unité. El respaldo alto tiene un coste extra de 47 euros por unidad.**

Removable upholstery in back and auxiliary cushions.

Wooden frame covered with flexible cold shaped polyurethane foam and polyester fibre.

Suspension consisting of fibreglass reinforced plastic slats.

Seats in different polyurethane foam densities, with surface padding in fibre. Back cushions stuffed with polyester fibre and washed, sterilised down. Auxiliary cushions stuffed with polyester fibre and washed, sterilised down.

LDPE bases.

Two back cushions heights available: Standard (82 cm - 32.28 in) or High (92 cm - 36.22)

Tapiserie déhoussable sur les coussins du dossier et coussins auxiliaires.

Cadre en bois recouvert de mousse de polyuréthane souple à froid et de fibre de polyester.

Suspension au moyen de lattes renforcées avec de la fibre de verre.

Assise réalisé dans différentes densités de mousse polyuréthane, matelassé en surface avec du fibre. Coussins du dossier garnis de fibre de polyester et plumes lavées et stérilisées. Coussins auxiliaires garnis de fibre de polyester et plumes lavées et stérilisées.

Pieds en PEBD.

Deux hauteurs de coussin pour les dossiers disponibles : Standard (82 cm) ou Haut (92 cm)

Tapicería desenfundable en cojines de respaldo y cojines auxiliares.

Bastidor de madera recubierto de espuma de poliuretano flexible en frío y fibra de poliéster.

Suspensión mediante lamas de plástico reforzadas con fibra de vidrio.

Asientos realizados en distintas densidades de espuma de poliuretano, acolchados en la superficie con fibra. Cojines de respaldo rellenos de fibra de poliéster y pluma lavada y esterilizada. Cojines auxiliares rellenos de fibra de poliéster y pluma lavada y esterilizada.

Pies en LDPE.

Dos alturas de respaldo disponibles: Estándar (82 cm) o Alto (92 cm)

## SERENE.

### GENERAL MEASUREMENTS. MESURES GÉNÉRALES. MEDIDAS GENERALES.

---

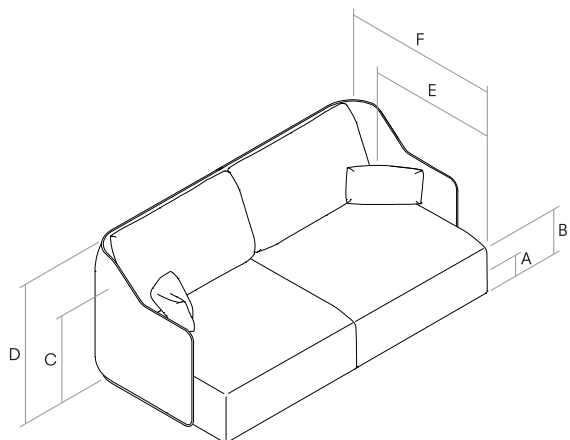

- A. Base height. Hauteur de base. Altura de base. 5 cm - 1.97"
- B. Seat height. Hauteur du siège. Altura de asiento. 42 cm - 16.54"
- C. Arm height. Hauteur du bras. Altura de brazo. 56 cm - 22.05"
- D. Backrest height. Hauteur du dossier. Altura de respaldo. 82 cm - 32.28"
- E. Seat depth. Profondeur d'assise. Profundidad de sentada. 58 cm - 22.83"
- F. Depth. Profondeur. Profundidad. 98 cm - 38.58"

### FINISHES. TRAITS. ACABADOS.

---

Finishes for the feet. Finitions des pieds. Acabados de las patas.

---

Low density polyethylene. Polyéthylène basse densité. Polietileno de baja densidad.

---



LDPE  
PEBD

### OPTIONAL BACK CUSHIONS. COUSSINS DU DOSSIER EN OPTION. COJINES DE RESPALDO OPCIONALES.

---

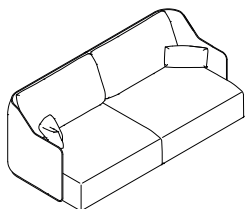

Standard option. Option standard. Opción estándar.  
Backrest height. Hauteur du dossier. Altura de respaldo.  
**82 cm - 32.28"**

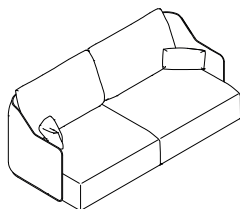

Premium option. Option premium. Opción premium.  
Backrest height. Hauteur du dossier. Altura de respaldo.  
**92 cm - 36.22"**

## SERENE.

### FINISHES. TRAITS. ACABADOS.

Wood finishes. Finitions bois. Acabado de la madera.



**RN**  
Natural oak.  
Chêne naturel.  
Roble natural.



**NA**  
Natural american walnut.  
Noyer américain.  
Nogal americano.



**RT**  
Dark stained oak.  
Chêne teint foncée.  
Roble teñido oscuro.



**RL**  
Oak painted in black with open-pore finish.  
Chêne laqué noir à pores ouverts.  
Roble lacado negro por abierto.

Lacquered. Laqué. Lacados.



SEDA



ALOE



KHAKI



BRICK



RUBI



KOKOA

## CONFIGURATOR.

Compatibility between furniture and upholstered elements. Compatibilité entre les meubles et les éléments tapissés. Compatibilidad entre mobiliario y elementos tapizados.

|  | REFERENCE.      | Supported references. Références compatibles. Referencias compatibles. |                                   |              |
|--|-----------------|--|-----------------------------------|--------------|
|  | <b>SERMU149</b> | SERS170BTPSBB  | SERSI165BTPSBB - SERSD165BTPSBB   | SERS0160BTPS |
|  | <b>SERMU169</b> | SERS190BTPSBB  | SERSI185BTPSBB - SERSD185BTPSBB   | SERS0180BTPS |
|  | <b>SERMU189</b> | SERS210BTPSBB  |                                   |              |
|  | <b>SERMU209</b> | SERS230BTPSBB  |                                   |              |
|  | <b>SERMU229</b> | SERS250BTPSBB  | SERSI245BTPSBB - SERSD245BTPSBB   | SERS0240BTPS |
|  | <b>SERMU162</b> | SERRI174BTPS - SERRD174BTPS  | SERSRI263BTPSBB - SERSRD263BTPSBB |              |
|  | <b>SERMU172</b> | SERRI184BTPS - SERRD184BTPS  | SERSRI283BTPSBB - SERSRD283BTPSBB |              |
|  | <b>SERMU83</b>  | SERCLI98BTPSBB - SERCLD98BTPSBB  |                                   |              |
|  | <b>SERMU93</b>  | SERCLI108BTPSBB - SERCLD108BTPSBB                                      |                                   |              |

SERENE.

PRICES. PRIX. PRECIOS.

SERENE. Sofa. Canapé. Sofá.



**SERS170BTPSBB**

170 x 98 H82  
66.93"x 38.58" H32.28"

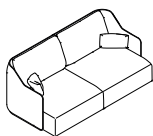

**SERS190BTPSBB**

190 x 98 H82  
74.80"x 38.58" H32.28"



**SERS210BTPSBB**

210 x 98 H82  
82.68"x 38.58" H32.28"

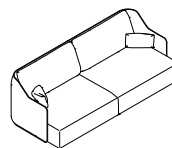

**SERS230BTPSBB**

230 x 98 H82  
90.55"x 38.58" H32.28"

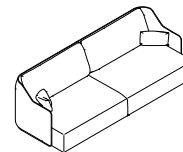

**SERS250BTPSBB**

250 x 98 H82  
98.43"x 38.58" H32.28"

| MEASUREMENT. MESURE. MEDIDA.          | REF.          | M.L. | COM / COL | 1        | 2        | 3        | 4        | 5        | L1       | L2       |
|---------------------------------------|---------------|------|-----------|----------|----------|----------|----------|----------|----------|----------|
| 170 x 98 H82   66.93"x 38.58" H32.28" | SERS170BTPSBB | 11.5 | 2.148,76  | 2.247,93 | 2.413,22 | 2.561,98 | 2.859,50 | 3.429,75 | 3.545,45 | 4.111,57 |
| 190 x 98 H82   74.80"x 38.58" H32.28" | SERS190BTPSBB | 11.5 | 2.326,45  | 2.429,75 | 2.570,25 | 2.727,27 | 3.037,19 | 3.595,04 | 3.735,54 | 4.272,73 |
| 210 x 98 H82   82.68"x 38.58" H32.28" | SERS210BTPSBB | 12   | 2.438,02  | 2.528,93 | 2.685,95 | 2.842,98 | 3.157,02 | 3.735,54 | 3.851,24 | 4.421,49 |
| 230 x 98 H82   90.55"x 38.58" H32.28" | SERS230BTPSBB | 12   | 2.623,97  | 2.727,27 | 2.896,69 | 3.045,45 | 3.367,77 | 3.954,55 | 4.095,04 | 4.665,29 |
| 250 x 98 H82   98.43"x 38.58" H32.28" | SERS250BTPSBB | 12.5 | 2.805,79  | 2.896,69 | 3.061,98 | 3.235,54 | 3.545,45 | 4.140,50 | 4.272,73 | 4.859,50 |

## SERENE.

### PRICES. PRIX. PRECIOS.

SERENE. Furniture for sofas, sofas with 1 arm, and without arms. Meubles pour canapés, canapés avec 1 accoudoir et sans accoudoirs. Muebles para sofás, para sofás con 1 brazo y para sofás sin brazos.



**SERMU149**

149 x 25 H43

63.78" x 9.84" H16.93"



**SERMU169**

169 x 25 H43

66.54" x 9.84" H16.93"

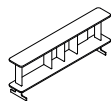

**SERMU189**

189 x 25 H43

74.41" x 9.84" H16.93"

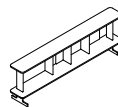

**SERMU209**

209 x 25 H43

82.28" x 9.84" H16.93"

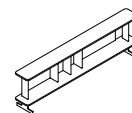

**SERMU229**

229 x 25 H43

90.16" x 9.84" H16.93"

| MEASUREMENT. MESURE. MEDIDA.          | FINISHES. TRAITS. ACABADOS.   | REF.       | PRICE. PRIX. PRECIO. |
|---------------------------------------|---|------------|----------------------|
| 149 x 25 H43   63.78" x 9.84" H16.93" | Natural oak. Chêne naturel. Roble natural.  | SERMU149RN | 1.161,16             |
| 149 x 25 H43   63.78" x 9.84" H16.93" | American walnut. Noyer américain. Nogal americano.  | SERMU149NA | 1.256,20             |
| 149 x 25 H43   63.78" x 9.84" H16.93" | Dark stained oak. Chêne teinté foncé. Roble teñido oscuro.  | SERMU149RT | 1.161,16             |
| 149 x 25 H43   63.78" x 9.84" H16.93" | Oak painted in black with open-pore finish. Chêne laqué noir à pores ouverts. Roble lacado negro por abierto. | SERMU149RL | 1.256,20             |
| 149 x 25 H43   63.78" x 9.84" H16.93" | Matt lacquer. Laque mate. Lacado mate.  | SERMU149LA | 1.161,16             |
| 169 x 25 H43   66.54" x 9.84" H16.93" | Natural oak. Chêne naturel. Roble natural.  | SERMU169RN | 1.235,54             |
| 169 x 25 H43   66.54" x 9.84" H16.93" | American walnut. Noyer américain. Nogal americano.  | SERMU169NA | 1.342,98             |
| 169 x 25 H43   66.54" x 9.84" H16.93" | Dark stained oak. Chêne teinté foncé. Roble teñido oscuro.  | SERMU169RT | 1.235,54             |
| 169 x 25 H43   66.54" x 9.84" H16.93" | Oak painted in black with open-pore finish. Chêne laqué noir à pores ouverts. Roble lacado negro por abierto. | SERMU169RL | 1.342,98             |
| 169 x 25 H43   66.54" x 9.84" H16.93" | Matt lacquer. Laque mate. Lacado mate.  | SERMU169LA | 1.235,54             |
| 189 x 25 H43   74.41" x 9.84" H16.93" | Natural oak. Chêne naturel. Roble natural.  | SERMU189RN | 1.355,37             |
| 189 x 25 H43   74.41" x 9.84" H16.93" | American walnut. Noyer américain. Nogal americano.  | SERMU189NA | 1.442,15             |
| 189 x 25 H43   74.41" x 9.84" H16.93" | Dark stained oak. Chêne teinté foncé. Roble teñido oscuro.  | SERMU189RT | 1.322,31             |
| 189 x 25 H43   74.41" x 9.84" H16.93" | Oak painted in black with open-pore finish. Chêne laqué noir à pores ouverts. Roble lacado negro por abierto. | SERMU189RL | 1.442,15             |
| 189 x 25 H43   74.41" x 9.84" H16.93" | Matt lacquer. Laque mate. Lacado mate.  | SERMU189LA | 1.322,31             |
| 209 x 25 H43   82.28" x 9.84" H16.93" | Natural oak. Chêne naturel. Roble natural.  | SERMU209RN | 1.396,69             |
| 209 x 25 H43   82.28" x 9.84" H16.93" | American walnut. Noyer américain. Nogal americano.  | SERMU209NA | 1.495,87             |
| 209 x 25 H43   82.28" x 9.84" H16.93" | Dark stained oak. Chêne teinté foncé. Roble teñido oscuro.  | SERMU209RT | 1.396,69             |
| 209 x 25 H43   82.28" x 9.84" H16.93" | Oak painted in black with open-pore finish. Chêne laqué noir à pores ouverts. Roble lacado negro por abierto. | SERMU209RL | 1.495,87             |
| 209 x 25 H43   82.28" x 9.84" H16.93" | Matt lacquer. Laque mate. Lacado mate.  | SERMU209LA | 1.396,69             |
| 229 x 25 H43   90.16" x 9.84" H16.93" | Natural oak. Chêne naturel. Roble natural.  | SERMU229RN | 1.508,26             |
| 229 x 25 H43   90.16" x 9.84" H16.93" | American walnut. Noyer américain. Nogal americano.  | SERMU229NA | 1.603,31             |
| 229 x 25 H43   90.16" x 9.84" H16.93" | Dark stained oak. Chêne teinté foncé. Roble teñido oscuro.  | SERMU229RT | 1.508,26             |
| 229 x 25 H43   90.16" x 9.84" H16.93" | Oak painted in black with open-pore finish. Chêne laqué noir à pores ouverts. Roble lacado negro por abierto. | SERMU229RL | 1.603,31             |
| 229 x 25 H43   90.16" x 9.84" H16.93" | Matt lacquer. Laque mate. Lacado mate.  | SERMU229LA | 1.508,26             |

## SERENE.

### PRICES. PRIX. PRECIOS.

SERENE. Furniture for chaise longue. Meubles pour chaise longue. Muebles para chaise longue.



#### SERMU83

83 x 25 H43  
32.68" x 9.84" H16.93"



#### SERMU93

93 x 25 H43  
36.61" x 9.84" H16.93"

| MEASUREMENT. MESURE. MEDIDA.         | FINISHES. TRAITS. ACABADOS.   | REF.      | PRICE. PRIX. PRECIO. |
|--------------------------------------|---|-----------|----------------------|
| 83 x 25 H43   32.68" x 9.84" H16.93" | Natural oak. Chêne naturel. Roble natural.  | SERMU83RN | 954,55               |
| 83 x 25 H43   32.68" x 9.84" H16.93" | American walnut. Noyer américain. Nogal americano.  | SERMU83NA | 1.020,66             |
| 83 x 25 H43   32.68" x 9.84" H16.93" | Dark stained oak. Chêne teinté foncé. Roble teñido oscuro.  | SERMU83RT | 954,55               |
| 83 x 25 H43   32.68" x 9.84" H16.93" | Oak painted in black with open-pore finish. Chêne laqué noir à pores ouverts. Roble lacado negro por abierto. | SERMU83RL | 1.020,66             |
| 83 x 25 H43   32.68" x 9.84" H16.93" | Matt lacquer. Laque mate. Lacado mate.  | SERMU83LA | 954,55               |
| 93 x 25 H43   36.61" x 9.84" H16.93" | Natural oak. Chêne naturel. Roble natural.  | SERMU93RN | 987,60               |
| 93 x 25 H43   36.61" x 9.84" H16.93" | American walnut. Noyer américain. Nogal americano.  | SERMU93NA | 1.041,32             |
| 93 x 25 H43   36.61" x 9.84" H16.93" | Dark stained oak. Chêne teinté foncé. Roble teñido oscuro.  | SERMU93RT | 987,60               |
| 93 x 25 H43   36.61" x 9.84" H16.93" | Oak painted in black with open-pore finish. Chêne laqué noir à pores ouverts. Roble lacado negro por abierto. | SERMU93RL | 1.041,32             |
| 93 x 25 H43   36.61" x 9.84" H16.93" | Matt lacquer. Laque mate. Lacado mate.  | SERMU93LA | 987,60               |

SERENE. Furniture for corner and sofa corner. Meubles pour angle et canapé angle. Muebles para rincón y sofá rincón.



#### SERMU162

162 x 25 H43  
63.78" x 9.84" H16.93"

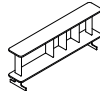

#### SERMU172

172 x 25 H43  
67.72" x 9.84" H16.93"

| MEASUREMENT. MESURE. MEDIDA.          | FINISHES. TRAITS. ACABADOS.   | REF.       | PRICE. PRIX. PRECIO. |
|---------------------------------------|---|------------|----------------------|
| 162 x 25 H43   63.78" x 9.84" H16.93" | Natural oak. Chêne naturel. Roble natural.  | SERMU162RN | 1.214,88             |
| 162 x 25 H43   63.78" x 9.84" H16.93" | American walnut. Noyer américain. Nogal americano.  | SERMU162NA | 1.314,05             |
| 162 x 25 H43   63.78" x 9.84" H16.93" | Dark stained oak. Chêne teinté foncé. Roble teñido oscuro.  | SERMU162RT | 1.214,88             |
| 162 x 25 H43   63.78" x 9.84" H16.93" | Oak painted in black with open-pore finish. Chêne laqué noir à pores ouverts. Roble lacado negro por abierto. | SERMU162RL | 1.314,05             |
| 162 x 25 H43   63.78" x 9.84" H16.93" | Matt lacquer. Laque mate. Lacado mate.  | SERMU162LA | 1.214,88             |
| 172 x 25 H43   67.72" x 9.84" H16.93" | Natural oak. Chêne naturel. Roble natural.  | SERMU172RN | 1.293,39             |
| 172 x 25 H43   67.72" x 9.84" H16.93" | American walnut. Noyer américain. Nogal americano.  | SERMU172NA | 1.421,49             |
| 172 x 25 H43   67.72" x 9.84" H16.93" | Dark stained oak. Chêne teinté foncé. Roble teñido oscuro.  | SERMU172RT | 1.293,39             |
| 172 x 25 H43   67.72" x 9.84" H16.93" | Oak painted in black with open-pore finish. Chêne laqué noir à pores ouverts. Roble lacado negro por abierto. | SERMU172RL | 1.421,49             |
| 172 x 25 H43   67.72" x 9.84" H16.93" | Matt lacquer. Laque mate. Lacado mate.  | SERMU172LA | 1.293,39             |

SERENE.

PRICES. PRIX. PRECIOS.

SEAT CUSHION 80 CM. COUSSIN DE L'ASSISE DE 80 CM. COJÍN DE ASIENTO DE 80 CM.

SERENE. Sofas with 1 arm. Canapés avec 1 accoudoir. Sofás con 1 brazo.

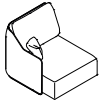

**SERSI85BTPSBB**

85 x 98 H82  
33.46" x 38.58" H32.28"  
IZQ.

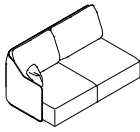

**SERSI165BTPSBB**

165 x 98 H82  
64.96" x 38.58" H32.28"  
IZQ.

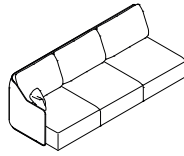

**SERSI245BTPSBB**

245 x 98 H82  
96.46" x 38.58" H32.28"  
IZQ.

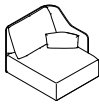

**SERSD85BTPSBB**

85 x 98 H82  
33.46" x 38.58" H32.28"  
DER.

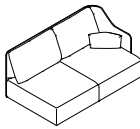

**SERSD165BTPSBB**

165 x 98 H82  
64.96" x 38.58" H32.28"  
DER.

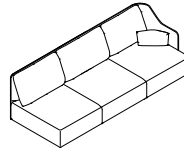

**SERSD245BTPSBB**

245 x 98 H82  
96.46" x 38.58" H32.28"  
DER.

| MEASUREMENT. MESURE. MEDIDA.           | REF.                            | M.L. | COM / COL | 1        | 2        | 3        | 4        | 5        | L1       | L2       |
|--|---------------------------------|------|-----------|----------|----------|----------|----------|----------|----------|----------|
| 85 x 98 H82   33.46" x 38.58" H32.28"  | SERSI85BTPSBB - SERSD85BTPSBB   | 7    | 1.326,45  | 1.388,43 | 1.466,94 | 1.528,93 | 1.702,48 | 1.983,47 | 2.037,19 | 2.326,45 |
| 165 x 98 H82   64.96" x 38.58" H32.28" | SERSI165BTPSBB - SERSD165BTPSBB | 10   | 1.991,74  | 2.090,91 | 2.231,40 | 2.351,24 | 2.623,97 | 3.132,23 | 3.235,54 | 3.735,54 |
| 245 x 98 H82   96.46" x 38.58" H32.28" | SERSI245BTPSBB - SERSD245BTPSBB | 15   | 2.805,79  | 2.913,22 | 3.132,23 | 3.280,99 | 3.657,02 | 4.330,58 | 4.479,34 | 5.157,02 |

SERENE. Sofas without arms. Canapés sans accoudoirs. Sofás sin brazos.

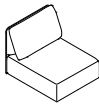

**SERS080BTPS**

80 x 98 H82  
31.50" x 38.58" H32.28"

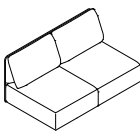

**SERS0160BTPS**

160 x 98 H82  
62.99" x 38.58" H32.28"

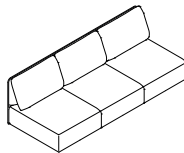

**SERS0240BTPS**

240 x 98 H82  
94.49" x 38.58" H32.28"

| MEASUREMENT. MESURE. MEDIDA.           | REF.         | M.L. | COM / COL | 1        | 2        | 3        | 4        | 5        | L1       | L2       |
|--|--------------|------|-----------|----------|----------|----------|----------|----------|----------|----------|
| 80 X 98 H82   31.50" x 42.52" H32.28"  | SERS080BTPS  | 6    | 1.136,36  | 1.169,42 | 1.231,40 | 1.285,12 | 1.404,96 | 1.623,97 | 1.661,16 | 1.888,43 |
| 160 x 98 H82   62.99" x 42.52" H32.28" | SERS0160BTPS | 9.5  | 1.780,99  | 1.842,98 | 1.966,94 | 2.090,91 | 2.309,92 | 2.727,27 | 2.826,45 | 3.243,80 |
| 240 x 98 H82   94.49" x 42.52" H32.28" | SERS0240BTPS | 14.5 | 2.561,98  | 2.657,02 | 2.826,45 | 3.000,00 | 3.326,45 | 3.946,28 | 4.086,78 | 4.681,82 |



## SERENE.

PRICES. PRIX. PRECIOS.

SEAT CUSHION 80 CM. COUSSIN DE L'ASSISE DE 80 CM. COJÍN DE ASIENTO DE 80 CM.

SERENE. Corner and sofa corner. Angle et canapé angle. Rincón y sofá rincón.

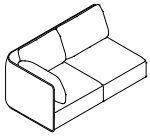

**SERRI174BTPS**

174 x 98 H82  
68.50" x 38.58" H32.28"  
IZQ.

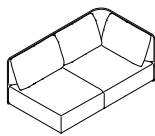

**SERRD174BTPS**

174 x 98 H82  
68.50" x 38.58" H32.28"  
DER.

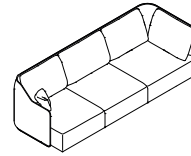

**SERSRI263BTPSBB**

263 x 98 H82  
103.54" x 38.58" H32.28"  
IZQ.

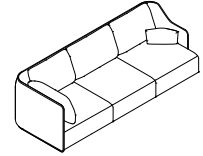

**SERSRD263BTPSBB**

263 x 98 H82  
103.54" x 38.58" H32.28"  
DER.

| MEASUREMENT. MESURE. MEDIDA.            | REF.                              | M.L. | COM / COL | 1        | 2        | 3        | 4        | 5        | L1       | L2       |
|---|-----------------------------------|------|-----------|----------|----------|----------|----------|----------|----------|----------|
| 174 x 98 H82   68.50" x 38.58" H32.28"  | SERRI174BTPS - SERRD174BTPS       | 11   | 2.202,48  | 2.297,52 | 2.450,41 | 2.599,17 | 2.896,69 | 3.429,75 | 3.545,45 | 4.086,78 |
| 263 x 98 H82   103.54" x 38.58" H32.28" | SERSRI263BTPSBB - SERSRD263BTPSBB | 15.5 | 3.024,79  | 3.157,02 | 3.376,03 | 3.611,57 | 4.070,25 | 4.867,77 | 5.041,32 | 5.863,64 |

SERENE. Ottomans. Poufs. Ottomans.



**SERP80BTPS**

80 x 94 H42  
31.50" x 37.01" H16.54"

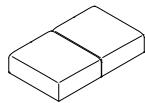

**SERP160BTPS**

160 x 94 H42  
62.99" x 37.01" H16.54"

| MEASUREMENT. MESURE. MEDIDA.           | REF.        | M.L. | COM / COL | 1        | 2        | 3        | 4        | 5        | L1       | L2       |
|--|-------------|------|-----------|----------|----------|----------|----------|----------|----------|----------|
| 80 x 94 H42   31.50" x 37.01" H16.54"  | SERP80BTPS  | 2.5  | 590,91    | 615,70   | 644,63   | 669,42   | 731,40   | 747,93   | 855,37   | 983,47   |
| 160 x 94 H42   62.99" x 37.01" H16.54" | SERP160BTPS | 4.5  | 1.053,72  | 1.082,64 | 1.136,36 | 1.177,69 | 1.285,12 | 1.466,94 | 1.504,13 | 1.677,69 |

SERENE. Chaise longues.

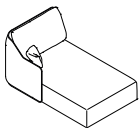

**SERCLI98BTPSBB**

98 x 160 H82  
38.58" x 62.99" H32.28"  
IZQ.

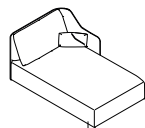

**SERCLD98BTPSBB**

98 x 160 H82  
38.58" x 62.99" H32.28"  
DER.

| MEASUREMENT. MESURE. MEDIDA.           | REF.                            | M.L. | COM / COL | 1        | 2        | 3        | 4        | 5        | L1       | L2       |
|--|---------------------------------|------|-----------|----------|----------|----------|----------|----------|----------|----------|
| 98 x 160 H82   38.58" x 62.99" H32.28" | SERCLI98BTPSBB - SERCLD98BTPSBB | 7.5  | 1.756,20  | 1.801,65 | 1.896,69 | 1.983,47 | 2.169,42 | 2.491,74 | 2.570,25 | 2.896,69 |

## SERENE.

PRICES. PRIX. PRECIOS.

SEAT CUSHION 90 CM. COUSSIN DE L'ASSISE DE 90 CM. COJÍN DE ASIENTO DE 90 CM.

SERENE. Sofas with 1 arm. Canapés avec 1 accoudoir. Sofás con 1 brazo.

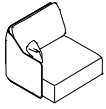

**SERSI95BTSPBB**

95 x 98 H82  
37.40" x 38.58" H32.28"  
IZQ.

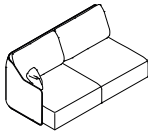

**SERSI185BTSPBB**

185 x 98 H82  
72.83" x 38.58" H32.28"  
IZQ.

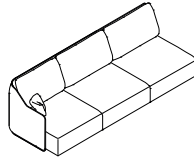

**SERSI275BTSPBB**

275 x 98 H82  
108.27" x 38.58" H32.28"  
IZQ.

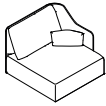

**SERSD95BTSPBB**

95 x 98 H82  
37.40" x 38.58" H32.28"  
DER.

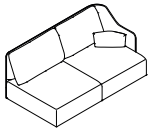

**SERSD185BTSPBB**

185 x 98 H82  
72.83" x 38.58" H32.28"  
DER.

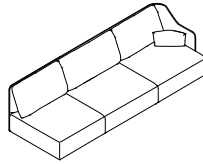

**SERSD275BTSPBB**

275 x 98 H82  
108.27" x 38.58" H32.28"  
DER.

| MEASUREMENT. MESURE. MEDIDA.            | REF.                            | M.L. | COM / COL | 1        | 2        | 3        | 4        | 5        | L1       | L2       |
|---|---------------------------------|------|-----------|----------|----------|----------|----------|----------|----------|----------|
| 95 x 98 H82   37.40" x 38.58" H32.28"   | SERSI95BTSPBB - SERSD95BTSPBB   | 8    | 1.421,49  | 1.466,94 | 1.537,19 | 1.623,97 | 1.780,99 | 2.090,91 | 2.140,50 | 2.438,02 |
| 185 x 98 H82   72.83" x 38.58" H32.28"  | SERSI185BTSPBB - SERSD185BTSPBB | 11   | 2.185,95  | 2.264,46 | 2.413,22 | 2.545,45 | 2.826,45 | 3.305,79 | 3.429,75 | 3.913,22 |
| 275 x 98 H82   108.27" x 38.58" H32.28" | SERSI275BTSPBB - SERSD275BTSPBB | 15.5 | 3.024,79  | 3.148,76 | 3.334,71 | 3.533,06 | 3.929,75 | 4.628,10 | 4.789,26 | 5.487,60 |

SERENE. Sofas without arms. Canapés sans accoudoirs. Sofás sin brazo.

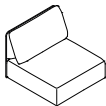

**SERS090BTSP**

90 x 98 H82  
35.43" x 38.58" H32.28"

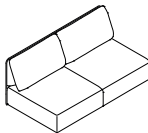

**SERS0180BTSP**

180 x 98 H82  
70.87" x 38.58" H32.28"

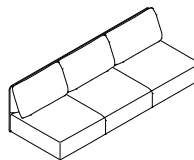

**SERS0270BTSP**

270 x 98 H82  
106.30" x 38.58" H32.28"

| MEASUREMENT. MESURE. MEDIDA.            | REF.         | M.L. | COM / COL | 1        | 2        | 3        | 4        | 5        | L1       | L2       |
|---|--------------|------|-----------|----------|----------|----------|----------|----------|----------|----------|
| 90 X 98 H82   35.43" x 42.52" H32.28"   | SERS090BTSP  | 7.5  | 1.239,67  | 1.285,12 | 1.355,37 | 1.421,49 | 1.561,98 | 1.834,71 | 1.888,43 | 2.148,76 |
| 180 x 98 H82   70.87" x 42.52" H32.28"  | SERS0180BTSP | 11   | 2.000,00  | 2.082,64 | 2.202,48 | 2.326,45 | 2.561,98 | 2.975,21 | 3.078,51 | 3.508,26 |
| 270 x 98 H82   106.30" x 42.52" H32.28" | SERS0270BTSP | 15.5 | 2.805,79  | 2.913,22 | 3.086,78 | 3.264,46 | 3.615,70 | 4.243,80 | 4.376,03 | 5.016,53 |

## SERENE.

PRICES. PRIX. PRECIOS.

SEAT CUSHION 90 CM. COUSSIN DE L'ASSISE DE 90 CM. COJÍN DE ASIENTO DE 90 CM.

SERENE. Corner and sofa corner. Angle et canapé angle. Rincón y sofá rincón.

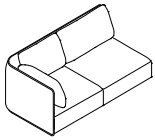

**SERRI184BTPS**

184 x 98 H82  
72.44" x 38.58" H32.28"  
IZQ.

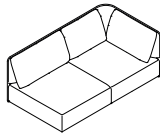

**SERRD184BTPS**

184 x 98 H82  
72.44" x 38.58" H32.28"  
DER.

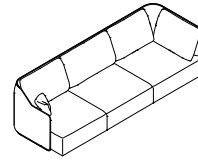

**SERSRI283BTPSBB**

283 x 98 H82  
111.42" x 38.58" H32.28"  
IZQ.

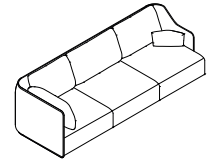

**SERSRD283BTPSBB**

283 x 98 H82  
111.42" x 38.58" H32.28"  
DER.

| MEASUREMENT. MESURE. MEDIDA.            | REF.                              | M.L. | COM / COL | 1        | 2        | 3        | 4        | 5        | L1       | L2       |
|---|-----------------------------------|------|-----------|----------|----------|----------|----------|----------|----------|----------|
| 184 x 98 H82   72.44" x 38.58" H32.28"  | SERRI184BTPS - SERRD184BTPS       | 11   | 2.309,92  | 2.404,96 | 2.561,98 | 2.694,21 | 3.000,00 | 3.533,06 | 3.657,02 | 4.210,74 |
| 283 x 98 H82   111.42" x 38.58" H32.28" | SERSRI283BTPSBB - SERSRD283BTPSBB | 16   | 3.235,54  | 3.359,50 | 3.586,78 | 3.805,79 | 4.260,33 | 5.078,51 | 5.260,33 | 6.082,64 |

SERENE. Ottomans. Poufs. Ottomans.

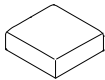

**SERP90BTPS**

90 x 94 H42  
35.43" x 37.01" H16.54"

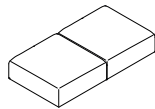

**SERP180BTPS**

180 x 94 H42  
70.87" x 37.01" H16.54"

| MEASUREMENT. MESURE. MEDIDA.           | REF.        | M.L. | COM / COL | 1        | 2        | 3        | 4        | 5        | L1       | L2       |
|--|-------------|------|-----------|----------|----------|----------|----------|----------|----------|----------|
| 90 x 94 H42   35.43" x 37.01" H16.54"  | SERP90BTPS  | 3    | 636,36    | 652,89   | 677,69   | 723,14   | 776,86   | 888,43   | 904,96   | 1.020,66 |
| 180 x 94 H42   70.87" x 37.01" H16.54" | SERP180BTPS | 5    | 1.169,42  | 1.194,21 | 1.256,20 | 1.318,18 | 1.421,49 | 1.599,17 | 1.644,63 | 1.834,71 |

SERENE. Chaise longues.

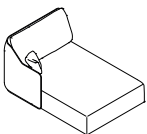

**SERCLI108BTPSBB**

108 x 160 H82  
42.52" x 62.99" H32.28"  
IZQ.

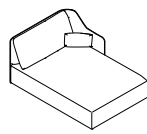

**SERCLD108BTPSBB**

108 x 160 H82  
42.52" x 62.99" H32.28"  
DER.

| MEASUREMENT. MESURE. MEDIDA.            | REF.                              | M.L. | COM / COL | 1        | 2        | 3        | 4        | 5        | L1       | L2       |
|---|-----------------------------------|------|-----------|----------|----------|----------|----------|----------|----------|----------|
| 108 x 160 H82   42.52" x 62.99" H32.28" | SERCLI108BTPSBB - SERCLD108BTPSBB | 7.5  | 1.859,50  | 1.929,75 | 2.020,66 | 2.123,97 | 2.326,45 | 2.677,69 | 2.764,46 | 3.115,70 |

# SERENE.

# SOFA. CANAPÉ. SOFÁ.



Designer  
Mario Ruiz

STYLE. ESTILO.  
Singular

VERSION. VERSIÓN.  
Floor standing. Ras du sol. Base a suelo.

VARIANTS. VARIANTES.  
Deluxe depth. Profondeur deluxe. Profundidad deluxe. (108 cm - 42.52 in)  
High arm. Accoudoir haut. Brazo alto.

## FEATURES. TRAITS. CARACTERÍSTICAS.

**The high backrest costs an extra 47 euros per unit. Le dossier haut coûte 47 euros de plus par unité. El respaldo alto tiene un coste extra de 47 euros por unidad.**

Removable upholstery in back and auxiliary cushions.

Wooden frame covered with flexible cold shaped polyurethane foam and polyester fibre.

Suspension consisting of fibreglass reinforced plastic slats.

Seats in different polyurethane foam densities, with surface padding in fibre. Back cushions stuffed with polyester fibre and washed, sterilised down. Auxiliary cushions stuffed with polyester fibre and washed, sterilised down.

LDPE bases.

Two back cushions heights available: Standard (82 cm - 32.28 in) or High (92 cm - 36.22)

Tapiserie déhoussable sur les coussins du dossier et coussins auxiliaires.

Cadre en bois recouvert de mousse de polyuréthane souple à froid et de fibre de polyester.

Suspension au moyen de lattes renforcées avec de la fibre de verre.

Assise réalisé dans différentes densités de mousse polyuréthane, matelassé en surface avec du fibre. Coussins du dossier garnis de fibre de polyester et plumes lavées et stérilisées. Coussins auxiliaires garnis de fibre de polyester et plumes lavées et stérilisées.

Pieds en PEBD.

Deux hauteurs de coussin pour les dossiers disponibles : Standard (82 cm) ou Haut (92 cm)

Tapicería desenfundable en cojines de respaldo y cojines auxiliares.

Bastidor de madera recubierto de espuma de poliuretano flexible en frío y fibra de poliéster.

Suspensión mediante lamas de plástico reforzadas con fibra de vidrio.

Asientos realizados en distintas densidades de espuma de poliuretano, acolchados en la superficie con fibra. Cojines de respaldo rellenos de fibra de poliéster y pluma lavada y esterilizada. Cojines auxiliares rellenos de fibra de poliéster y pluma lavada y esterilizada.

Pies en LDPE.

Dos alturas de respaldo disponibles: Estándar (82 cm) o Alto (92 cm)

## SERENE.

### GENERAL MEASUREMENTS. MESURES GÉNÉRALES. MEDIDAS GENERALES.

---

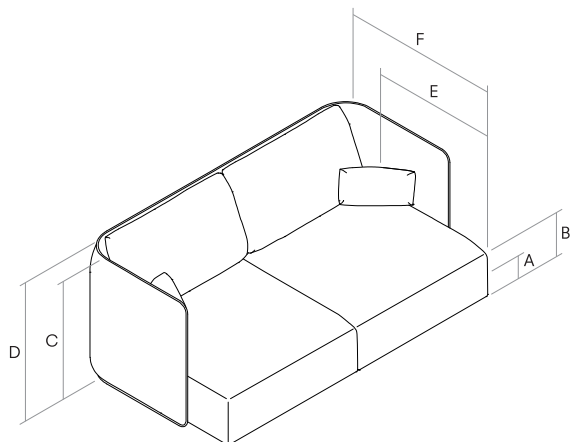

- A. Base height. Hauteur de base. Altura de base. 5 cm - 1.97"
- B. Seat height. Hauteur du siège. Altura de asiento. 42 cm - 16.54"
- C. Arm height. Hauteur du bras. Altura de brazo. 77 cm - 30.31"
- D. Backrest height. Hauteur du dossier. Altura de respaldo. 82 cm - 32.28"
- E. Seat depth. Profondeur d'assise. Profundidad de sentada. 68 cm - 26.77"
- F. Depth. Profondeur. Profundidad. 108 cm - 42.52"

### FINISHES. TRAITS. ACABADOS.

---

Finishes for the feet. Finitions des pieds. Acabados de las patas.

---

Low density polyethylene. Polyéthylène basse densité. Polietileno de baja densidad.

---



LDPE  
PEBD

### OPTIONAL BACK CUSHIONS. COUSSINS DU DOSSIER EN OPTION. COJINES DE RESPALDO OPCIONALES.

---

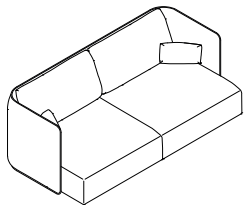

Standard option. Option standard. Opción estándar.  
Backrest height. Hauteur du dossier. Altura de respaldo.  
**82 cm - 32.28"**

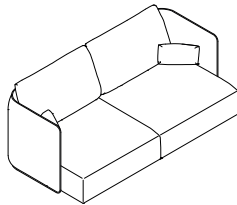

Premium option. Option premium. Opción premium.  
Backrest height. Hauteur du dossier. Altura de respaldo.  
**92 cm - 36.22"**

## SERENE.

### FINISHES. TRAITS. ACABADOS.

Wood finishes. Finitions bois. Acabado de la madera.



**RN**  
Natural oak.  
Chêne naturel.  
Roble natural.



**NA**  
Natural american walnut.  
Noyer américain.  
Nogal americano.



**RT**  
Dark stained oak.  
Chêne teint foncée.  
Roble teñido oscuro.



**RL**  
Oak painted in black with open-pore finish.  
Chêne laqué noir à pores ouverts.  
Roble lacado negro por abierto.

Lacquered. Laqué. Lacados.



SEDA



ALOE



KHAKI



BRICK











RUBI



KOKOA

## CONFIGURATOR.

Compatibility between furniture and upholstered elements. Compatibilité entre les meubles et les éléments tapissés. Compatibilidad entre mobiliario y elementos tapizados.

|  | REFERENCE.      | Supported references. Références compatibles. Referencias compatibles. |                                   |              |
|--|-----------------|--|-----------------------------------|--------------|
|  | <b>SERMU149</b> | SERS170BTPDBA  | SERS1165BTPDBA - SERSD165BTPDBA   | SERS0160BTPD |
|  | <b>SERMU169</b> | SERS190BTPDBA  | SERS1185BTPDBA - SERSD185BTPDBA   | SERS0180BTPD |
|  | <b>SERMU189</b> | SERS210BTPDBA  |                                   |              |
|  | <b>SERMU209</b> | SERS230BTPDBA  |                                   |              |
|  | <b>SERMU229</b> | SERS250BTPDBA  | SERS1245BTPDBA - SERSD245BTPDBA   | SERS0240BTPD |
|  | <b>SERMU162</b> | SERRI174BTPD - SERRD174BTPD  | SERSRI263BTPDBA - SERSRD263BTPDBA |              |
|  | <b>SERMU172</b> | SERRI184BTPD - SERRD184BTPD  | SERSRI283BTPDBA - SERSRD283BTPDBA |              |
|  | <b>SERMU83</b>  | SERCLI98BTPDBA - SERCLD98BTPDBA  |                                   |              |
|  | <b>SERMU93</b>  | SERCLI108BTPDBA - SERCLD108BTPDBA                                      |                                   |              |

SERENE.

PRICES. PRIX. PRECIOS.

SERENE. Sofa. Canapé. Sofá.

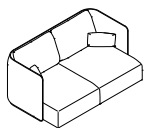

**SERS170BTPDBA**

170 x 108 H82  
66.93"x 42.52" H32.28"

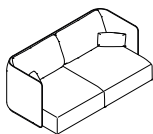

**SERS190BTPDBA**

190 x 108 H82  
74.80"x 42.52" H32.28"

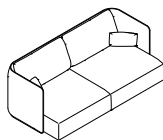

**SERS210BTPDBA**

210 x 108 H82  
82.68"x 42.52" H32.28"

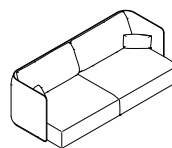

**SERS230BTPDBA**

230 x 108 H82  
90.55"x 42.52" H32.28"

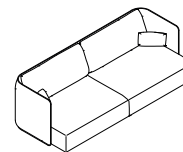

**SERS250BTPDBA**

250 x 108 H82  
98.43"x 42.52" H32.28"

| MEASUREMENT. MESURE. MEDIDA.           | REF.          | M.L. | COM / COL | 1        | 2        | 3        | 4        | 5        | L1       | L2       |
|--|---------------|------|-----------|----------|----------|----------|----------|----------|----------|----------|
| 170 x 108 H82   66.93"x 42.52" H32.28" | SERS170BTPDBA | 12   | 2.264,46  | 2.359,50 | 2.528,93 | 2.677,69 | 3.000,00 | 3.570,25 | 3.681,82 | 4.260,33 |
| 190 x 108 H82   74.80"x 42.52" H32.28" | SERS190BTPDBA | 12   | 2.438,02  | 2.537,19 | 2.694,21 | 2.851,24 | 3.165,29 | 3.743,80 | 3.859,50 | 4.438,02 |
| 210 x 108 H82   82.68"x 42.52" H32.28" | SERS210BTPDBA | 12.5 | 2.570,25  | 2.657,02 | 2.826,45 | 2.975,21 | 3.297,52 | 3.867,77 | 4.000,00 | 4.586,78 |
| 230 x 108 H82   90.55"x 42.52" H32.28" | SERS230BTPDBA | 12.5 | 2.772,73  | 2.859,50 | 3.024,79 | 3.194,21 | 3.524,79 | 4.132,23 | 4.252,07 | 4.838,84 |
| 250 x 108 H82   98.43"x 42.52" H32.28" | SERS250BTPDBA | 13   | 2.946,28  | 3.045,45 | 3.202,48 | 3.367,77 | 3.710,74 | 4.297,52 | 4.438,02 | 5.016,53 |

## SERENE.

### PRICES. PRIX. PRECIOS.

SERENE. Furniture for sofas, sofas with 1 arm, and without arms. Meubles pour canapés, canapés avec 1 accoudoir et sans accoudoirs. Muebles para sofás, para sofás con 1 brazo y para sofás sin brazos.



**SERMU149**

149 x 25 H43

63.78" x 9.84" H16.93"



**SERMU169**

169 x 25 H43

66.54" x 9.84" H16.93"

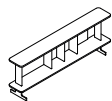

**SERMU189**

189 x 25 H43

74.41" x 9.84" H16.93"

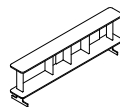

**SERMU209**

209 x 25 H43

82.28" x 9.84" H16.93"

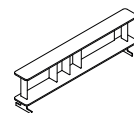

**SERMU229**

229 x 25 H43

90.16" x 9.84" H16.93"

| MEASUREMENT. MESURE. MEDIDA.          | FINISHES. TRAITS. ACABADOS.   | REF.       | PRICE. PRIX. PRECIO. |
|---------------------------------------|---|------------|----------------------|
| 149 x 25 H43   63.78" x 9.84" H16.93" | Natural oak. Chêne naturel. Roble natural.  | SERMU149RN | 1.161,16             |
| 149 x 25 H43   63.78" x 9.84" H16.93" | American walnut. Noyer américain. Nogal americano.  | SERMU149NA | 1.256,20             |
| 149 x 25 H43   63.78" x 9.84" H16.93" | Dark stained oak. Chêne teinté foncé. Roble teñido oscuro.  | SERMU149RT | 1.161,16             |
| 149 x 25 H43   63.78" x 9.84" H16.93" | Oak painted in black with open-pore finish. Chêne laqué noir à pores ouverts. Roble lacado negro por abierto. | SERMU149RL | 1.256,20             |
| 149 x 25 H43   63.78" x 9.84" H16.93" | Matt lacquer. Laque mate. Lacado mate.  | SERMU149LA | 1.161,16             |
| 169 x 25 H43   66.54" x 9.84" H16.93" | Natural oak. Chêne naturel. Roble natural.  | SERMU169RN | 1.235,54             |
| 169 x 25 H43   66.54" x 9.84" H16.93" | American walnut. Noyer américain. Nogal americano.  | SERMU169NA | 1.342,98             |
| 169 x 25 H43   66.54" x 9.84" H16.93" | Dark stained oak. Chêne teinté foncé. Roble teñido oscuro.  | SERMU169RT | 1.235,54             |
| 169 x 25 H43   66.54" x 9.84" H16.93" | Oak painted in black with open-pore finish. Chêne laqué noir à pores ouverts. Roble lacado negro por abierto. | SERMU169RL | 1.342,98             |
| 169 x 25 H43   66.54" x 9.84" H16.93" | Matt lacquer. Laque mate. Lacado mate.  | SERMU169LA | 1.235,54             |
| 189 x 25 H43   74.41" x 9.84" H16.93" | Natural oak. Chêne naturel. Roble natural.  | SERMU189RN | 1.355,37             |
| 189 x 25 H43   74.41" x 9.84" H16.93" | American walnut. Noyer américain. Nogal americano.  | SERMU189NA | 1.442,15             |
| 189 x 25 H43   74.41" x 9.84" H16.93" | Dark stained oak. Chêne teinté foncé. Roble teñido oscuro.  | SERMU189RT | 1.322,31             |
| 189 x 25 H43   74.41" x 9.84" H16.93" | Oak painted in black with open-pore finish. Chêne laqué noir à pores ouverts. Roble lacado negro por abierto. | SERMU189RL | 1.442,15             |
| 189 x 25 H43   74.41" x 9.84" H16.93" | Matt lacquer. Laque mate. Lacado mate.  | SERMU189LA | 1.322,31             |
| 209 x 25 H43   82.28" x 9.84" H16.93" | Natural oak. Chêne naturel. Roble natural.  | SERMU209RN | 1.396,69             |
| 209 x 25 H43   82.28" x 9.84" H16.93" | American walnut. Noyer américain. Nogal americano.  | SERMU209NA | 1.495,87             |
| 209 x 25 H43   82.28" x 9.84" H16.93" | Dark stained oak. Chêne teinté foncé. Roble teñido oscuro.  | SERMU209RT | 1.396,69             |
| 209 x 25 H43   82.28" x 9.84" H16.93" | Oak painted in black with open-pore finish. Chêne laqué noir à pores ouverts. Roble lacado negro por abierto. | SERMU209RL | 1.495,87             |
| 209 x 25 H43   82.28" x 9.84" H16.93" | Matt lacquer. Laque mate. Lacado mate.  | SERMU209LA | 1.396,69             |
| 229 x 25 H43   90.16" x 9.84" H16.93" | Natural oak. Chêne naturel. Roble natural.  | SERMU229RN | 1.508,26             |
| 229 x 25 H43   90.16" x 9.84" H16.93" | American walnut. Noyer américain. Nogal americano.  | SERMU229NA | 1.603,31             |
| 229 x 25 H43   90.16" x 9.84" H16.93" | Dark stained oak. Chêne teinté foncé. Roble teñido oscuro.  | SERMU229RT | 1.508,26             |
| 229 x 25 H43   90.16" x 9.84" H16.93" | Oak painted in black with open-pore finish. Chêne laqué noir à pores ouverts. Roble lacado negro por abierto. | SERMU229RL | 1.603,31             |
| 229 x 25 H43   90.16" x 9.84" H16.93" | Matt lacquer. Laque mate. Lacado mate.  | SERMU229LA | 1.508,26             |



SERENE.

PRICES. PRIX. PRECIOS.

SERENE. Furniture for chaise longue. Meubles pour chaise longue. Muebles para chaise longue.



**SERMU83**

83 x 25 H43  
32.68" x 9.84" H16.93"



**SERMU93**

93 x 25 H43  
36.61" x 9.84" H16.93"

| MEASUREMENT. MESURE. MEDIDA.         | FINISHES. TRAITS. ACABADOS.   | REF.      | PRICE. PRIX. PRECIO. |
|--------------------------------------|---|-----------|----------------------|
| 83 x 25 H43   32.68" x 9.84" H16.93" | Natural oak. Chêne naturel. Roble natural.  | SERMU83RN | 954,55               |
| 83 x 25 H43   32.68" x 9.84" H16.93" | American walnut. Noyer américain. Nogal americano.  | SERMU83NA | 1.020,66             |
| 83 x 25 H43   32.68" x 9.84" H16.93" | Dark stained oak. Chêne teinté foncé. Roble teñido oscuro.  | SERMU83RT | 954,55               |
| 83 x 25 H43   32.68" x 9.84" H16.93" | Oak painted in black with open-pore finish. Chêne laqué noir à pores ouverts. Roble lacado negro por abierto. | SERMU83RL | 1.020,66             |
| 83 x 25 H43   32.68" x 9.84" H16.93" | Matt lacquer. Laque mate. Lacado mate.  | SERMU83LA | 954,55               |
| 93 x 25 H43   36.61" x 9.84" H16.93" | Natural oak. Chêne naturel. Roble natural.  | SERMU93RN | 987,60               |
| 93 x 25 H43   36.61" x 9.84" H16.93" | American walnut. Noyer américain. Nogal americano.  | SERMU93NA | 1.041,32             |
| 93 x 25 H43   36.61" x 9.84" H16.93" | Dark stained oak. Chêne teinté foncé. Roble teñido oscuro.  | SERMU93RT | 987,60               |
| 93 x 25 H43   36.61" x 9.84" H16.93" | Oak painted in black with open-pore finish. Chêne laqué noir à pores ouverts. Roble lacado negro por abierto. | SERMU93RL | 1.041,32             |
| 93 x 25 H43   36.61" x 9.84" H16.93" | Matt lacquer. Laque mate. Lacado mate.  | SERMU93LA | 987,60               |

SERENE. Furniture for corner and sofa corner. Meubles pour angle et canapé angle. Muebles para rincón y sofá rincón.



**SERMU162**

162 x 25 H43  
63.78" x 9.84" H16.93"

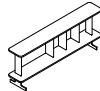

**SERMU172**

172 x 25 H43  
67.72" x 9.84" H16.93"

| MEASUREMENT. MESURE. MEDIDA.          | FINISHES. TRAITS. ACABADOS.   | REF.       | PRICE. PRIX. PRECIO. |
|---------------------------------------|---|------------|----------------------|
| 162 x 25 H43   63.78" x 9.84" H16.93" | Natural oak. Chêne naturel. Roble natural.  | SERMU162RN | 1.214,88             |
| 162 x 25 H43   63.78" x 9.84" H16.93" | American walnut. Noyer américain. Nogal americano.  | SERMU162NA | 1.314,05             |
| 162 x 25 H43   63.78" x 9.84" H16.93" | Dark stained oak. Chêne teinté foncé. Roble teñido oscuro.  | SERMU162RT | 1.214,88             |
| 162 x 25 H43   63.78" x 9.84" H16.93" | Oak painted in black with open-pore finish. Chêne laqué noir à pores ouverts. Roble lacado negro por abierto. | SERMU162RL | 1.314,05             |
| 162 x 25 H43   63.78" x 9.84" H16.93" | Matt lacquer. Laque mate. Lacado mate.  | SERMU162LA | 1.214,88             |
| 172 x 25 H43   67.72" x 9.84" H16.93" | Natural oak. Chêne naturel. Roble natural.  | SERMU172RN | 1.293,39             |
| 172 x 25 H43   67.72" x 9.84" H16.93" | American walnut. Noyer américain. Nogal americano.  | SERMU172NA | 1.421,49             |
| 172 x 25 H43   67.72" x 9.84" H16.93" | Dark stained oak. Chêne teinté foncé. Roble teñido oscuro.  | SERMU172RT | 1.293,39             |
| 172 x 25 H43   67.72" x 9.84" H16.93" | Oak painted in black with open-pore finish. Chêne laqué noir à pores ouverts. Roble lacado negro por abierto. | SERMU172RL | 1.421,49             |
| 172 x 25 H43   67.72" x 9.84" H16.93" | Matt lacquer. Laque mate. Lacado mate.  | SERMU172LA | 1.293,39             |

## SERENE.

PRICES. PRIX. PRECIOS.

SEAT CUSHION 80 CM. COUSSIN DE L'ASSISE DE 80 CM. COJÍN DE ASIENTO DE 80 CM.

SERENE. Sofas with 1 arm. Canapés avec 1 accoudoir. Sofás con 1 brazo.

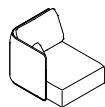

**SERSI85BTPDBA**

85 x 108 H82  
33.46" x 42.52" H32.28"  
IZQ.

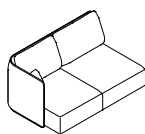

**SERSI165BTPDBA**

165 x 108 H82  
64.96" x 42.52" H32.28"  
IZQ.

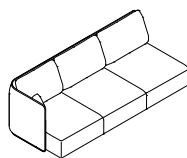

**SERSI245BTPDBA**

245 x 108 H82  
96.46" x 42.52" H32.28"  
IZQ.

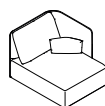

**SERSD85BTPDBA**

85 x 108 H82  
33.46" x 42.52" H32.28"  
DER.

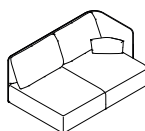

**SERSD165BTPDBA**

165 x 108 H82  
64.96" x 42.52" H32.28"  
DER.

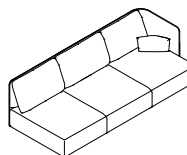

**SERSD245BTPDBA**

245 x 108 H82  
96.46" x 42.52" H32.28"  
DER.

| MEASUREMENT. MESURE. MEDIDA.            | REF.                            | M.L. | COM / COL | 1        | 2        | 3        | 4        | 5        | L1       | L2       |
|---|---------------------------------|------|-----------|----------|----------|----------|----------|----------|----------|----------|
| 85 x 108 H82   33.46" x 42.52" H32.28"  | SERSI85BTPDBA - SERSD85BTPDBA   | 7    | 1.396,69  | 1.442,15 | 1.520,66 | 1.607,44 | 1.764,46 | 2.061,98 | 2.123,97 | 2.413,22 |
| 165 x 108 H82   64.96" x 42.52" H32.28" | SERSI165BTPDBA - SERSD165BTPDBA | 10.5 | 2.099,17  | 2.177,69 | 2.326,45 | 2.458,68 | 2.739,67 | 3.243,80 | 3.359,50 | 3.859,50 |
| 245 x 108 H82   96.46" x 42.52" H32.28" | SERSI245BTPDBA - SERSD245BTPDBA | 15   | 2.929,75  | 3.037,19 | 3.243,80 | 3.438,02 | 3.805,79 | 4.487,60 | 4.657,02 | 5.338,84 |

SERENE. Sofas without arms. Canapés sans accoudoirs. Sofás sin brazos.

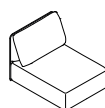

**SERS080BTPD**

80 x 108 H82  
31.50" x 42.52" H32.28"

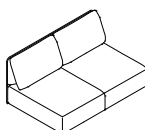

**SERS0160BTPD**

160 x 108 H82  
62.99" x 42.52" H32.28"

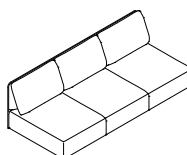

**SERS0240BTPD**

240 x 108 H82  
94.49" x 42.52" H32.28"

| MEASUREMENT. MESURE. MEDIDA.            | REF.         | M.L. | COM / COL | 1        | 2        | 3        | 4        | 5        | L1       | L2       |
|---|--------------|------|-----------|----------|----------|----------|----------|----------|----------|----------|
| 80 X 108 H82   31.50" x 42.52" H32.28"  | SERS080BTPD  | 6    | 1.177,69  | 1.231,40 | 1.272,73 | 1.342,98 | 1.466,94 | 1.677,69 | 1.731,40 | 1.950,41 |
| 160 x 108 H82   62.99" x 42.52" H32.28" | SERS0160BTPD | 9.5  | 1.851,24  | 1.929,75 | 2.037,19 | 2.169,42 | 2.413,22 | 2.826,45 | 2.929,75 | 3.351,24 |
| 240 x 108 H82   94.49" x 42.52" H32.28" | SERS0240BTPD | 14.5 | 2.694,21  | 2.797,52 | 2.975,21 | 3.148,76 | 3.500,00 | 4.132,23 | 4.260,33 | 4.876,03 |

SERENE.

PRICES. PRIX. PRECIOS.

SEAT CUSHION 80 CM. COUSSIN DE L'ASSISE DE 80 CM. COJÍN DE ASIENTO DE 80 CM.

SERENE. Corner and sofa corner. Angle et canapé angle. Rincón y sofá rincón.

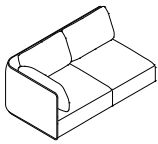

**SERRI184BTPD**

184 x 108 H82  
72.44" x 42.52" H32.28"  
IZQ.

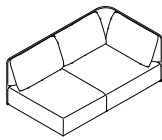

**SERRD184BTPD**

184 x 108 H82  
72.44" x 42.52" H32.28"  
DER.

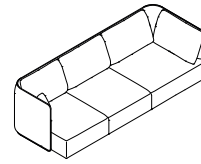

**SERSRI273BTPDBA**

273 x 108 H82  
107.48" x 42.52" H32.28"  
IZQ.

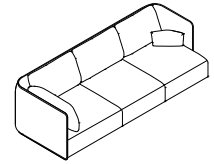

**SERSRD273BTPDBA**

273 x 108 H82  
107.48" x 42.52" H32.28"  
DER.

| MEASUREMENT. MESURE. MEDIDA.             | REF.                              | M.L. | COM / COL | 1        | 2        | 3        | 4        | 5        | L1       | L2       |
|--|-----------------------------------|------|-----------|----------|----------|----------|----------|----------|----------|----------|
| 184 x 108 H82   72.44" x 42.52" H32.28"  | SERRI184BTPD - SERRD184BTPD       | 11.5 | 2.342,98  | 2.438,02 | 2.586,78 | 2.739,67 | 3.037,19 | 3.595,04 | 3.710,74 | 4.260,33 |
| 273 x 108 H82   107.48" x 42.52" H32.28" | SERSRI273BTPDBA - SERSRD273BTPDBA | 16   | 3.194,21  | 3.326,45 | 3.561,98 | 3.789,26 | 4.243,80 | 5.049,59 | 5.243,80 | 6.049,59 |

SERENE. Ottomans. Poufs. Ottomans.

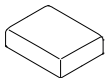

**SERP80BTPD**

80 x 104 H42  
31.50" x 40.94" H16.54"

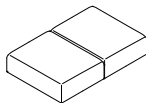

**SERP160BTPD**

160 x 104 H42  
62.99" x 40.94" H16.54"

| MEASUREMENT. MESURE. MEDIDA.            | REF.        | M.L. | COM / COL | 1        | 2        | 3        | 4        | 5        | L1       | L2       |
|---|-------------|------|-----------|----------|----------|----------|----------|----------|----------|----------|
| 80 x 104 H42   31.5" x 40.94" H16.54"   | SERP80BTPD  | 3    | 644,63    | 661,16   | 698,35   | 731,40   | 793,39   | 925,62   | 942,15   | 1.053,72 |
| 160 x 104 H42   62.99" x 40.94" H16.54" | SERP160BTPD | 5    | 1.152,89  | 1.169,42 | 1.239,67 | 1.285,12 | 1.396,69 | 1.590,91 | 1.623,97 | 1.826,45 |

SERENE. Chaise longues.

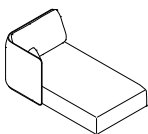

**SERCLI98BTPDBA**

98 x 170 H82  
38.58" x 66.93" H32.28"  
IZQ.

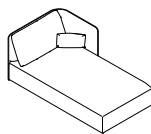

**SERCLD98BTPDBA**

98 x 170 H82  
38.58" x 66.93" H32.28"  
DER.

| MEASUREMENT. MESURE. MEDIDA.           | REF.                            | M.L. | COM / COL | 1        | 2        | 3        | 4        | 5        | L1       | L2       |
|--|---------------------------------|------|-----------|----------|----------|----------|----------|----------|----------|----------|
| 98 x 170 H82   38.58" x 66.93" H32.28" | SERCLI98BTPDBA - SERCLD98BTPDBA | 8    | 1.801,65  | 1.851,24 | 1.950,41 | 2.028,93 | 2.231,40 | 2.545,45 | 2.623,97 | 2.938,02 |

## SERENE.

PRICES. PRIX. PRECIOS.

SEAT CUSHION 90 CM. COUSSIN DE L'ASSISE DE 90 CM. COJÍN DE ASIENTO DE 90 CM.

SERENE. Sofas with 1 arm. Canapés avec 1 accoudoir. Sofás con 1 brazo.

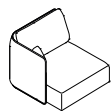

**SERSI95BTPDBA**

95 x 108 H82  
37.40" x 42.52" H32.28"  
IZQ.

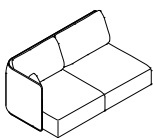

**SERSI185BTPDBA**

185 x 108 H82  
72.83" x 42.52" H32.28"  
IZQ.

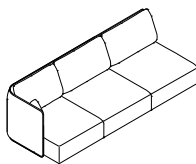

**SERSI275BTPDBA**

275 x 108 H82  
108.27" x 42.52" H32.28"  
IZQ.

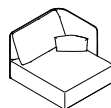

**SERSD95BTPDBA**

95 x 108 H82  
37.40" x 42.52" H32.28"  
DER.

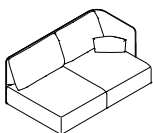

**SERSD185BTPDBA**

185 x 108 H82  
72.83" x 42.52" H32.28"  
DER.

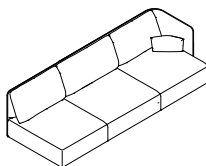

**SERSD275BTPDBA**

275 x 108 H82  
108.27" x 42.52" H32.28"  
DER.

| MEASUREMENT. MESURE. MEDIDA.             | REF.                            | M.L. | COM / COL | 1        | 2        | 3        | 4        | 5        | L1       | L2       |
|--|---------------------------------|------|-----------|----------|----------|----------|----------|----------|----------|----------|
| 95 x 108 H82   37.40" x 42.52" H32.28"   | SERSI95BTPDBA - SERSD95BTPDBA   | 8.5  | 1.483,47  | 1.528,93 | 1.623,97 | 1.702,48 | 1.859,50 | 2.169,42 | 2.231,40 | 2.528,93 |
| 185 x 108 H82   72.83" x 42.52" H32.28"  | SERSI185BTPDBA - SERSD185BTPDBA | 11.5 | 2.297,52  | 2.367,77 | 2.528,93 | 2.657,02 | 2.938,02 | 3.438,02 | 3.561,98 | 4.070,25 |
| 275 x 108 H82   108.27" x 42.52" H32.28" | SERSI275BTPDBA - SERSD275BTPDBA | 16   | 3.165,29  | 3.289,26 | 3.491,74 | 3.681,82 | 4.095,04 | 4.814,05 | 4.962,81 | 5.681,82 |

SERENE. Sofas without arms. Canapés sans accoudoirs. Sofás sin brazo.

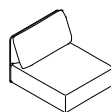

**SERS090BTPD**

90 x 108 H82  
35.43" x 42.52" H32.28"

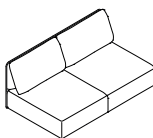

**SERS0180BTPD**

180 x 108 H82  
70.87" x 42.52" H32.28"

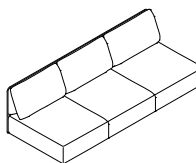

**SERS0270BTPD**

270 x 108 H82  
106.30" x 42.52" H32.28"

| MEASUREMENT. MESURE. MEDIDA.             | REF.         | M.L. | COM / COL | 1        | 2        | 3        | 4        | 5        | L1       | L2       |
|--|--------------|------|-----------|----------|----------|----------|----------|----------|----------|----------|
| 90 X 108 H82   35.43" x 42.52" H32.28"   | SERS090BTPD  | 7.5  | 1.285,12  | 1.326,45 | 1.404,96 | 1.483,47 | 1.632,23 | 1.896,69 | 1.958,68 | 2.231,40 |
| 180 x 108 H82   70.87" x 42.52" H32.28"  | SERS0180BTPD | 11   | 2.107,44  | 2.177,69 | 2.297,52 | 2.429,75 | 2.657,02 | 3.115,70 | 3.194,21 | 3.632,23 |
| 270 x 108 H82   106.30" x 42.52" H32.28" | SERS0270BTPD | 15.5 | 2.929,75  | 3.024,79 | 3.202,48 | 3.392,56 | 3.752,07 | 4.392,56 | 4.533,06 | 5.181,82 |

SERENE.

PRICES. PRIX. PRECIOS.

SEAT CUSHION 90 CM. COUSSIN DE L'ASSISE DE 90 CM. COJÍN DE ASIENTO DE 90 CM.

SERENE. Corner and sofa corner. Angle et canapé angle. Rincón y sofá rincón.

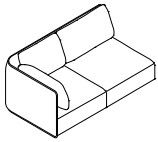

**SERRI194BTPD**

194 x 108 H82  
76.38" x 42.52" H32.28"  
IZQ.

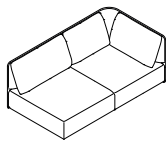

**SERRD194BTPD**

194 x 108 H82  
76.38" x 42.52" H32.28"  
DER.

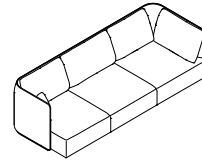

**SERSRI293BTPDBA**

293 x 108 H82  
115.35" x 42.52" H32.28"  
IZQ.

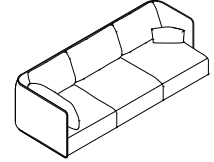

**SERSRD293BTPDBA**

293 x 108 H82  
115.35" x 42.52" H32.28"  
DER.

| MEASUREMENT. MESURE. MEDIDA.             | REF.                              | M.L. | COM / COL | 1        | 2        | 3        | 4        | 5        | L1       | L2       |
|--|-----------------------------------|------|-----------|----------|----------|----------|----------|----------|----------|----------|
| 194 x 108 H82   76.38" x 42.52" H32.28"  | SERRI194BTPD - SERRD194BTPD       | 11.5 | 2.458,68  | 2.545,45 | 2.694,21 | 2.842,98 | 3.157,02 | 3.710,74 | 3.830,58 | 4.392,56 |
| 293 x 108 H82   115.35" x 42.52" H32.28" | SERSRI293BTPDBA - SERSRD293BTPDBA | 16.5 | 3.413,22  | 3.545,45 | 3.780,99 | 4.008,26 | 4.462,81 | 5.285,12 | 5.462,81 | 6.285,12 |

SERENE. Ottomans. Poufs. Ottomans.

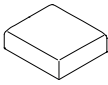

**SERP90BTPD**

90 x 104 H42  
35.43" x 40.94" H16.54"

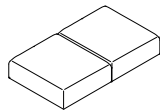

**SERP180BTPD**

180 x 104 H42  
70.87" x 40.94" H16.54"

| MEASUREMENT. MESURE. MEDIDA.            | REF.        | M.L. | COM / COL | 1        | 2        | 3        | 4        | 5        | L1       | L2       |
|---|-------------|------|-----------|----------|----------|----------|----------|----------|----------|----------|
| 90 x 104 H42   35.43" x 40.94" H16.54"  | SERP90BTPD  | 3    | 677,69    | 698,35   | 731,40   | 776,86   | 826,45   | 950,41   | 983,47   | 1.107,44 |
| 180 x 104 H42   70.87" x 40.94" H16.54" | SERP180BTPD | 5    | 1.272,73  | 1.301,65 | 1.363,64 | 1.413,22 | 1.528,93 | 1.731,40 | 1.772,73 | 1.975,21 |

SERENE. Chaise longues.

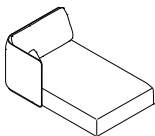

**SERCLI108BTPDBA**

108 x 170 H82  
42.52" x 32.28" H32.28"  
IZQ.

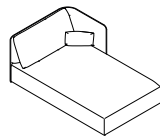

**SERCLD108BTPDBA**

108 x 170 H82  
42.52" x 32.28" H32.28"  
DER.

| MEASUREMENT. MESURE. MEDIDA.            | REF.                              | M.L. | COM / COL | 1        | 2        | 3        | 4        | 5        | L1       | L2       |
|---|-----------------------------------|------|-----------|----------|----------|----------|----------|----------|----------|----------|
| 108 x 170 H82   42.52" x 32.28" H32.28" | SERCLI108BTPDBA - SERCLD108BTPDBA | 8    | 1.929,75  | 1.983,47 | 2.090,91 | 2.185,95 | 2.388,43 | 2.747,93 | 2.826,45 | 3.185,95 |

# SERENE.

# SOFA. CANAPÉ. SOFÁ.



Designer  
Mario Ruiz

STYLE. ESTILO.  
Singular

VERSION. VERSIÓN.  
Upholstered base. Base tapissée. Base tapizada.

VARIANTS. VARIANTES.  
Deluxe depth. Profondeur deluxe. Profundidad deluxe. (108 cm - 42.52 in)  
Low arm. Accoudoir bas. Brazo bajo.

## FEATURES. TRAITS. CARACTERÍSTICAS.

**The high backrest costs an extra 47 euros per unit. Le dossier haut coûte 47 euros de plus par unité. El respaldo alto tiene un coste extra de 47 euros por unidad.**

Removable upholstery in back and auxiliary cushions.

Wooden frame covered with flexible cold shaped polyurethane foam and polyester fibre.

Suspension consisting of fibreglass reinforced plastic slats.

Seats in different polyurethane foam densities, with surface padding in fibre. Back cushions stuffed with polyester fibre and washed, sterilised down. Auxiliary cushions stuffed with polyester fibre and washed, sterilised down.

LDPE bases.

Two back cushions heights available: Standard (82 cm - 32.28 in) or High (92 cm - 36.22)

Tapiserie déhoussable sur les coussins du dossier et coussins auxiliaires.

Cadre en bois recouvert de mousse de polyuréthane souple à froid et de fibre de polyester.

Suspension au moyen de lattes renforcées avec de la fibre de verre.

Assise réalisé dans différentes densités de mousse polyuréthane, matelassé en surface avec du fibre. Coussins du dossier garnis de fibre de polyester et plumes lavées et stérilisées. Coussins auxiliaires garnis de fibre de polyester et plumes lavées et stérilisées.

Pieds en PEBD.

Deux hauteurs de coussin pour les dossiers disponibles : Standard (82 cm) ou Haut (92 cm)

Tapicería desenfundable en cojines de respaldo y cojines auxiliares.

Bastidor de madera recubierto de espuma de poliuretano flexible en frío y fibra de poliéster.

Suspensión mediante lamas de plástico reforzadas con fibra de vidrio.

Asientos realizados en distintas densidades de espuma de poliuretano, acolchados en la superficie con fibra. Cojines de respaldo rellenos de fibra de poliéster y pluma lavada y esterilizada. Cojines auxiliares rellenos de fibra de poliéster y pluma lavada y esterilizada.

Pies en LDPE.

Dos alturas de respaldo disponibles: Estándar (82 cm) o Alto (92 cm)

## SERENE.

### GENERAL MEASUREMENTS. MESURES GÉNÉRALES. MEDIDAS GENERALES.

---

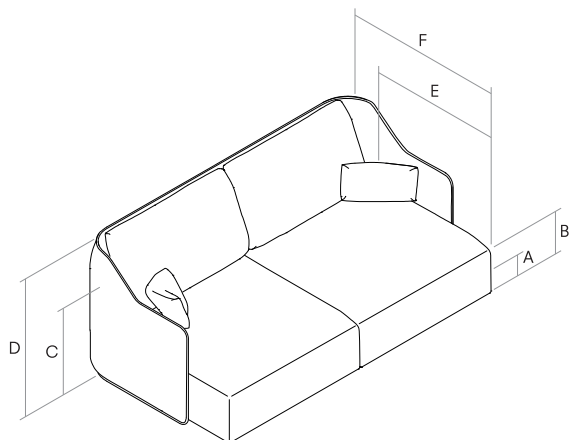

- A. Base height. Hauteur de base. Altura de base. 5 cm - 1.97"
- B. Seat height. Hauteur du siège. Altura de asiento. 42 cm - 16.54"
- C. Arm height. Hauteur du bras. Altura de brazo. 56 cm - 22.05"
- D. Backrest height. Hauteur du dossier. Altura de respaldo. 82 cm - 32.28"
- E. Seat depth. Profondeur d'assise. Profundidad de sentada. 68 cm - 26.77"
- F. Depth. Profondeur. Profundidad. 108 cm - 42.52"

### FINISHES. TRAITS. ACABADOS.

---

Finishes for the feet. Finitions des pieds. Acabados de las patas.

---

Low density polyethylene. Polyéthylène basse densité. Polietileno de baja densidad.

---



LDPE  
PEBD

### OPTIONAL BACK CUSHIONS. COUSSINS DU DOSSIER EN OPTION. COJINES DE RESPALDO OPCIONALES.

---

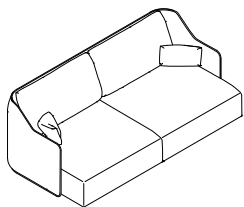

Standard option. Option standard. Opción estándar.  
Backrest height. Hauteur du dossier. Altura de respaldo.  
**82 cm - 32.28"**

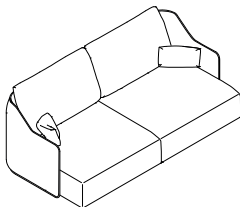

Premium option. Option premium. Opción premium.  
Backrest height. Hauteur du dossier. Altura de respaldo.  
**92 cm - 36.22"**

## SERENE.

### FINISHES. TRAITS. ACABADOS.

Wood finishes. Finitions bois. Acabado de la madera.



**RN**  
Natural oak.  
Chêne naturel.  
Roble natural.



**NA**  
Natural american walnut.  
Noyer américain.  
Nogal americano.



**RT**  
Dark stained oak.  
Chêne teint foncée.  
Roble teñido oscuro.



**RL**  
Oak painted in black with open-pore finish.  
Chêne laqué noir à pores ouverts.  
Roble lacado negro por abierto.

Lacquered. Laqué. Lacados.



SEDA



ALOE



KHAKI



BRICK











RUBI



KOKOA

## CONFIGURATOR.

Compatibility between furniture and upholstered elements. Compatibilité entre les meubles et les éléments tapissés. Compatibilidad entre mobiliario y elementos tapizados.

|   | REFERENCE.      | Supported references. Références compatibles. Referencias compatibles. |                                   |              |
|---|-----------------|--|-----------------------------------|--------------|
|  | <b>SERMU149</b> | SERS170BTPDDB  | SERSI165BTPDDB - SERSD165BTPDDB   | SERS0160BTPD |
|  | <b>SERMU169</b> | SERS190BTPDDB  | SERSI185BTPDDB - SERSD185BTPDDB   | SERS0180BTPD |
|  | <b>SERMU189</b> | SERS210BTPDDB  |                                   |              |
|  | <b>SERMU209</b> | SERS230BTPDDB  |                                   |              |
|  | <b>SERMU229</b> | SERS250BTPDDB  | SERSI245BTPDDB - SERSD245BTPDDB   | SERS0240BTPD |
|  | <b>SERMU162</b> | SERRI174BTPD - SERRD174BTPD  | SERSRI263BTPDDB - SERSRD263BTPDDB |              |
|  | <b>SERMU172</b> | SERRI184BTPD - SERRD184BTPD  | SERSRI283BTPDDB - SERSRD283BTPDDB |              |
|  | <b>SERMU83</b>  | SERCLI98BTPDDB - SERCLD98BTPDDB  |                                   |              |
|  | <b>SERMU93</b>  | SERCLI108BTPDDB - SERCLD108BTPDDB                                      |                                   |              |



SERENE.

PRICES. PRIX. PRECIOS.

SERENE. Sofa. Canapé. Sofá.



**SERS170BTPDBB**

170 x 108 H82  
66.93"x 42.52" H32.28"

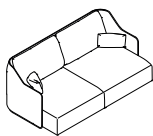

**SERS190BTPDBB**

190 x 108 H82  
74.80"x 42.52" H32.28"

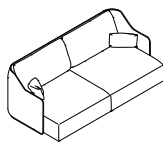

**SERS210BTPDBB**

210 x 108 H82  
82.68"x 42.52" H32.28"

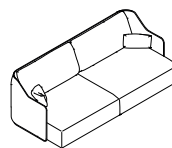

**SERS230BTPDBB**

230 x 108 H82  
90.55"x 42.52" H32.28"

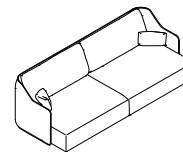

**SERS250BTPDBB**

250 x 108 H82  
98.43"x 42.52" H32.28"

| MEASUREMENT. MESURE. MEDIDA.           | REF.          | M.L. | COM / COL | 1        | 2        | 3        | 4        | 5        | L1       | L2       |
|--|---------------|------|-----------|----------|----------|----------|----------|----------|----------|----------|
| 170 x 108 H82   66.93"x 42.52" H32.28" | SERS170BTPDBB | 12   | 2.264,46  | 2.359,50 | 2.528,93 | 2.677,69 | 3.000,00 | 3.570,25 | 3.681,82 | 4.260,33 |
| 190 x 108 H82   74.80"x 42.52" H32.28" | SERS190BTPDBB | 12   | 2.438,02  | 2.537,19 | 2.694,21 | 2.851,24 | 3.165,29 | 3.743,80 | 3.859,50 | 4.438,02 |
| 210 x 108 H82   82.68"x 42.52" H32.28" | SERS210BTPDBB | 12.5 | 2.570,25  | 2.657,02 | 2.826,45 | 2.975,21 | 3.297,52 | 3.867,77 | 4.000,00 | 4.586,78 |
| 230 x 108 H82   90.55"x 42.52" H32.28" | SERS230BTPDBB | 12.5 | 2.772,73  | 2.859,50 | 3.024,79 | 3.194,21 | 3.524,79 | 4.132,23 | 4.252,07 | 4.838,84 |
| 250 x 108 H82   98.43"x 42.52" H32.28" | SERS250BTPDBB | 13   | 2.946,28  | 3.045,45 | 3.202,48 | 3.367,77 | 3.710,74 | 4.297,52 | 4.438,02 | 5.016,53 |

## SERENE.

### PRICES. PRIX. PRECIOS.

SERENE. Furniture for sofas, sofas with 1 arm, and without arms. Meubles pour canapés, canapés avec 1 accoudoir et sans accoudoirs. Muebles para sofás, para sofás con 1 brazo y para sofás sin brazos.



**SERMU149**

149 x 25 H43

63.78" x 9.84" H16.93"



**SERMU169**

169 x 25 H43

66.54" x 9.84" H16.93"

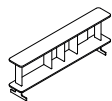

**SERMU189**

189 x 25 H43

74.41" x 9.84" H16.93"

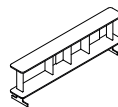

**SERMU209**

209 x 25 H43

82.28" x 9.84" H16.93"

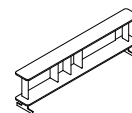

**SERMU229**

229 x 25 H43

90.16" x 9.84" H16.93"

| MEASUREMENT. MESURE. MEDIDA.          | FINISHES. TRAITS. ACABADOS.   | REF.       | PRICE. PRIX. PRECIO. |
|---------------------------------------|---|------------|----------------------|
| 149 x 25 H43   63.78" x 9.84" H16.93" | Natural oak. Chêne naturel. Roble natural.  | SERMU149RN | 1.161,16             |
| 149 x 25 H43   63.78" x 9.84" H16.93" | American walnut. Noyer américain. Nogal americano.  | SERMU149NA | 1.256,20             |
| 149 x 25 H43   63.78" x 9.84" H16.93" | Dark stained oak. Chêne teinté foncé. Roble teñido oscuro.  | SERMU149RT | 1.161,16             |
| 149 x 25 H43   63.78" x 9.84" H16.93" | Oak painted in black with open-pore finish. Chêne laqué noir à pores ouverts. Roble lacado negro por abierto. | SERMU149RL | 1.256,20             |
| 149 x 25 H43   63.78" x 9.84" H16.93" | Matt lacquer. Laque mate. Lacado mate.  | SERMU149LA | 1.161,16             |
| 169 x 25 H43   66.54" x 9.84" H16.93" | Natural oak. Chêne naturel. Roble natural.  | SERMU169RN | 1.235,54             |
| 169 x 25 H43   66.54" x 9.84" H16.93" | American walnut. Noyer américain. Nogal americano.  | SERMU169NA | 1.342,98             |
| 169 x 25 H43   66.54" x 9.84" H16.93" | Dark stained oak. Chêne teinté foncé. Roble teñido oscuro.  | SERMU169RT | 1.235,54             |
| 169 x 25 H43   66.54" x 9.84" H16.93" | Oak painted in black with open-pore finish. Chêne laqué noir à pores ouverts. Roble lacado negro por abierto. | SERMU169RL | 1.342,98             |
| 169 x 25 H43   66.54" x 9.84" H16.93" | Matt lacquer. Laque mate. Lacado mate.  | SERMU169LA | 1.235,54             |
| 189 x 25 H43   74.41" x 9.84" H16.93" | Natural oak. Chêne naturel. Roble natural.  | SERMU189RN | 1.355,37             |
| 189 x 25 H43   74.41" x 9.84" H16.93" | American walnut. Noyer américain. Nogal americano.  | SERMU189NA | 1.442,15             |
| 189 x 25 H43   74.41" x 9.84" H16.93" | Dark stained oak. Chêne teinté foncé. Roble teñido oscuro.  | SERMU189RT | 1.322,31             |
| 189 x 25 H43   74.41" x 9.84" H16.93" | Oak painted in black with open-pore finish. Chêne laqué noir à pores ouverts. Roble lacado negro por abierto. | SERMU189RL | 1.442,15             |
| 189 x 25 H43   74.41" x 9.84" H16.93" | Matt lacquer. Laque mate. Lacado mate.  | SERMU189LA | 1.322,31             |
| 209 x 25 H43   82.28" x 9.84" H16.93" | Natural oak. Chêne naturel. Roble natural.  | SERMU209RN | 1.396,69             |
| 209 x 25 H43   82.28" x 9.84" H16.93" | American walnut. Noyer américain. Nogal americano.  | SERMU209NA | 1.495,87             |
| 209 x 25 H43   82.28" x 9.84" H16.93" | Dark stained oak. Chêne teinté foncé. Roble teñido oscuro.  | SERMU209RT | 1.396,69             |
| 209 x 25 H43   82.28" x 9.84" H16.93" | Oak painted in black with open-pore finish. Chêne laqué noir à pores ouverts. Roble lacado negro por abierto. | SERMU209RL | 1.495,87             |
| 209 x 25 H43   82.28" x 9.84" H16.93" | Matt lacquer. Laque mate. Lacado mate.  | SERMU209LA | 1.396,69             |
| 229 x 25 H43   90.16" x 9.84" H16.93" | Natural oak. Chêne naturel. Roble natural.  | SERMU229RN | 1.508,26             |
| 229 x 25 H43   90.16" x 9.84" H16.93" | American walnut. Noyer américain. Nogal americano.  | SERMU229NA | 1.603,31             |
| 229 x 25 H43   90.16" x 9.84" H16.93" | Dark stained oak. Chêne teinté foncé. Roble teñido oscuro.  | SERMU229RT | 1.508,26             |
| 229 x 25 H43   90.16" x 9.84" H16.93" | Oak painted in black with open-pore finish. Chêne laqué noir à pores ouverts. Roble lacado negro por abierto. | SERMU229RL | 1.603,31             |
| 229 x 25 H43   90.16" x 9.84" H16.93" | Matt lacquer. Laque mate. Lacado mate.  | SERMU229LA | 1.508,26             |

## SERENE.

### PRICES. PRIX. PRECIOS.

SERENE. Furniture for chaise longue. Meubles pour chaise longue. Muebles para chaise longue.



#### SERMU83

83 x 25 H43  
32.68" x 9.84" H16.93"



#### SERMU93

93 x 25 H43  
36.61" x 9.84" H16.93"

| MEASUREMENT. MESURE. MEDIDA.         | FINISHES. TRAITS. ACABADOS.   | REF.      | PRICE. PRIX. PRECIO. |
|--------------------------------------|---|-----------|----------------------|
| 83 x 25 H43   32.68" x 9.84" H16.93" | Natural oak. Chêne naturel. Roble natural.  | SERMU83RN | 954,55               |
| 83 x 25 H43   32.68" x 9.84" H16.93" | American walnut. Noyer américain. Nogal americano.  | SERMU83NA | 1.020,66             |
| 83 x 25 H43   32.68" x 9.84" H16.93" | Dark stained oak. Chêne teinté foncé. Roble teñido oscuro.  | SERMU83RT | 954,55               |
| 83 x 25 H43   32.68" x 9.84" H16.93" | Oak painted in black with open-pore finish. Chêne laqué noir à pores ouverts. Roble lacado negro por abierto. | SERMU83RL | 1.020,66             |
| 83 x 25 H43   32.68" x 9.84" H16.93" | Matt lacquer. Laque mate. Lacado mate.  | SERMU83LA | 954,55               |
| 93 x 25 H43   36.61" x 9.84" H16.93" | Natural oak. Chêne naturel. Roble natural.  | SERMU93RN | 987,60               |
| 93 x 25 H43   36.61" x 9.84" H16.93" | American walnut. Noyer américain. Nogal americano.  | SERMU93NA | 1.041,32             |
| 93 x 25 H43   36.61" x 9.84" H16.93" | Dark stained oak. Chêne teinté foncé. Roble teñido oscuro.  | SERMU93RT | 987,60               |
| 93 x 25 H43   36.61" x 9.84" H16.93" | Oak painted in black with open-pore finish. Chêne laqué noir à pores ouverts. Roble lacado negro por abierto. | SERMU93RL | 1.041,32             |
| 93 x 25 H43   36.61" x 9.84" H16.93" | Matt lacquer. Laque mate. Lacado mate.  | SERMU93LA | 987,60               |

SERENE. Furniture for corner and sofa corner. Meubles pour angle et canapé angle. Muebles para rincón y sofá rincón.



#### SERMU162

162 x 25 H43  
63.78" x 9.84" H16.93"

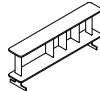

#### SERMU172

172 x 25 H43  
67.72" x 9.84" H16.93"

| MEASUREMENT. MESURE. MEDIDA.          | FINISHES. TRAITS. ACABADOS.   | REF.       | PRICE. PRIX. PRECIO. |
|---------------------------------------|---|------------|----------------------|
| 162 x 25 H43   63.78" x 9.84" H16.93" | Natural oak. Chêne naturel. Roble natural.  | SERMU162RN | 1.214,88             |
| 162 x 25 H43   63.78" x 9.84" H16.93" | American walnut. Noyer américain. Nogal americano.  | SERMU162NA | 1.314,05             |
| 162 x 25 H43   63.78" x 9.84" H16.93" | Dark stained oak. Chêne teinté foncé. Roble teñido oscuro.  | SERMU162RT | 1.214,88             |
| 162 x 25 H43   63.78" x 9.84" H16.93" | Oak painted in black with open-pore finish. Chêne laqué noir à pores ouverts. Roble lacado negro por abierto. | SERMU162RL | 1.314,05             |
| 162 x 25 H43   63.78" x 9.84" H16.93" | Matt lacquer. Laque mate. Lacado mate.  | SERMU162LA | 1.214,88             |
| 172 x 25 H43   67.72" x 9.84" H16.93" | Natural oak. Chêne naturel. Roble natural.  | SERMU172RN | 1.293,39             |
| 172 x 25 H43   67.72" x 9.84" H16.93" | American walnut. Noyer américain. Nogal americano.  | SERMU172NA | 1.421,49             |
| 172 x 25 H43   67.72" x 9.84" H16.93" | Dark stained oak. Chêne teinté foncé. Roble teñido oscuro.  | SERMU172RT | 1.293,39             |
| 172 x 25 H43   67.72" x 9.84" H16.93" | Oak painted in black with open-pore finish. Chêne laqué noir à pores ouverts. Roble lacado negro por abierto. | SERMU172RL | 1.421,49             |
| 172 x 25 H43   67.72" x 9.84" H16.93" | Matt lacquer. Laque mate. Lacado mate.  | SERMU172LA | 1.293,39             |

SERENE.

PRICES. PRIX. PRECIOS.

SEAT CUSHION 80 CM. COUSSIN DE L'ASSISE DE 80 CM. COJÍN DE ASIENTO DE 80 CM.

SERENE. Sofas with 1 arm. Canapés avec 1 accoudoir. Sofás con 1 brazo.

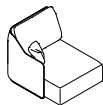

**SERSI85BTPDDB**

85 x 108 H82  
33.46"x 42.52" H32.28"  
IZQ.

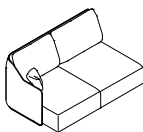

**SERSI165BTPDDB**

165 x 108 H82  
64.96"x 42.52" H32.28"  
IZQ.

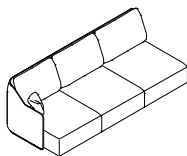

**SERSI245BTPDDB**

245 x 108 H82  
96.46"x 42.52" H32.28"  
IZQ.

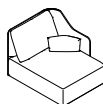

**SERSD85BTPDDB**

85 x 108 H82  
33.46"x 42.52" H32.28"  
DER.

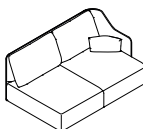

**SERSD165BTPDDB**

165 x 108 H82  
64.96"x 42.52" H32.28"  
DER.

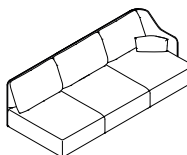

**SERSD245BTPDDB**

245 x 108 H82  
96.46"x 42.52" H32.28"  
DER.

| MEASUREMENT. MESURE. MEDIDA.           | REF.                            | M.L. | COM / COL | 1        | 2        | 3        | 4        | 5        | L1       | L2       |
|--|---------------------------------|------|-----------|----------|----------|----------|----------|----------|----------|----------|
| 85 x 108 H82   33.46"x 42.52" H32.28"  | SERSI85BTPDDB - SERSD85BTPDDB   | 7    | 1.396,69  | 1.442,15 | 1.520,66 | 1.607,44 | 1.764,46 | 2.061,98 | 2.123,97 | 2.413,22 |
| 165 x 108 H82   64.96"x 42.52" H32.28" | SERSI165BTPDDB - SERSD165BTPDDB | 10.5 | 2.099,17  | 2.177,69 | 2.326,45 | 2.458,68 | 2.739,67 | 3.243,80 | 3.359,50 | 3.859,50 |
| 245 x 108 H82   96.46"x 42.52" H32.28" | SERSI245BTPDDB - SERSD245BTPDDB | 15   | 2.929,75  | 3.037,19 | 3.243,80 | 3.438,02 | 3.805,79 | 4.487,60 | 4.657,02 | 5.338,84 |

SERENE. Sofas without arms. Canapés sans accoudoirs. Sofás sin brazos.

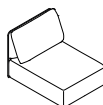

**SERS080BTPD**

80 x 108 H82  
31.50"x 42.52" H32.28"

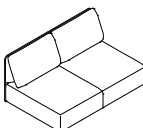

**SERS0160BTPD**

160 x 108 H82  
62.99"x 42.52" H32.28"

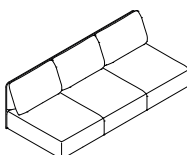

**SERS0240BTPD**

240 x 108 H82  
94.49"x 42.52" H32.28"

| MEASUREMENT. MESURE. MEDIDA.           | REF.         | M.L. | COM / COL | 1        | 2        | 3        | 4        | 5        | L1       | L2       |
|--|--------------|------|-----------|----------|----------|----------|----------|----------|----------|----------|
| 80 X 108 H82   31.50"x 42.52" H32.28"  | SERS080BTPD  | 6    | 1.177,69  | 1.231,40 | 1.272,73 | 1.342,98 | 1.466,94 | 1.677,69 | 1.731,40 | 1.950,41 |
| 160 x 108 H82   62.99"x 42.52" H32.28" | SERS0160BTPD | 9.5  | 1.851,24  | 1.929,75 | 2.037,19 | 2.169,42 | 2.413,22 | 2.826,45 | 2.929,75 | 3.351,24 |
| 240 x 108 H82   94.49"x 42.52" H32.28" | SERS0240BTPD | 14.5 | 2.694,21  | 2.797,52 | 2.975,21 | 3.148,76 | 3.500,00 | 4.132,23 | 4.260,33 | 4.876,03 |

## SERENE.

PRICES. PRIX. PRECIOS.

SEAT CUSHION 80 CM. COUSSIN DE L'ASSISE DE 80 CM. COJÍN DE ASIENTO DE 80 CM.

SERENE. Corner and sofa corner. Angle et canapé angle. Rincón y sofá rincón.

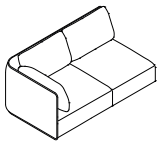

**SERRI184BTPD**

184 x 108 H82  
72.44" x 42.52" H32.28"  
IZQ.

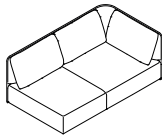

**SERRD184BTPD**

184 x 108 H82  
72.44" x 42.52" H32.28"  
DER.

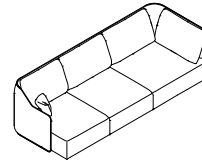

**SERSRI273BTPDBB**

273 x 108 H82  
107.48" x 42.52" H32.28"  
IZQ.

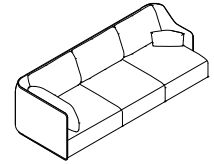

**SERSRD273BTPDBB**

273 x 108 H82  
107.48" x 42.52" H32.28"  
DER.

| MEASUREMENT. MESURE. MEDIDA.             | REF.                              | M.L. | COM / COL | 1        | 2        | 3        | 4        | 5        | L1       | L2       |
|--|-----------------------------------|------|-----------|----------|----------|----------|----------|----------|----------|----------|
| 184 x 108 H82   72.44" x 42.52" H32.28"  | SERRI184BTPD - SERRD184BTPD       | 11.5 | 2.342,98  | 2.438,02 | 2.586,78 | 2.739,67 | 3.037,19 | 3.595,04 | 3.710,74 | 4.260,33 |
| 273 x 108 H82   107.48" x 42.52" H32.28" | SERSRI273BTPDBB - SERSRD273BTPDBB | 16   | 3.194,21  | 3.326,45 | 3.561,98 | 3.789,26 | 4.243,80 | 5.049,59 | 5.243,80 | 6.049,59 |

SERENE. Ottomans. Poufs. Ottomans.

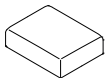

**SERP80BTPD**

80 x 104 H42  
31.50" x 40.94" H16.54"

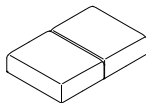

**SERP160BTPD**

160 x 104 H42  
62.99" x 40.94" H16.54"

| MEASUREMENT. MESURE. MEDIDA.            | REF.        | M.L. | COM / COL | 1        | 2        | 3        | 4        | 5        | L1       | L2       |
|---|-------------|------|-----------|----------|----------|----------|----------|----------|----------|----------|
| 80 x 104 H42   31.5" x 40.94" H16.54"   | SERP80BTPD  | 3    | 644,63    | 661,16   | 698,35   | 731,40   | 793,39   | 925,62   | 942,15   | 1.053,72 |
| 160 x 104 H42   62.99" x 40.94" H16.54" | SERP160BTPD | 5    | 1.152,89  | 1.169,42 | 1.239,67 | 1.285,12 | 1.396,69 | 1.590,91 | 1.623,97 | 1.826,45 |

SERENE. Chaise longues.

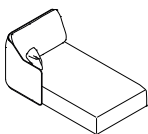

**SERCLI98BTPDBB**

98 x 170 H82  
38.58" x 66.93" H32.28"  
IZQ.

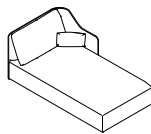

**SERCLD98BTPDBB**

98 x 170 H82  
38.58" x 66.93" H32.28"  
DER.

| MEASUREMENT. MESURE. MEDIDA.           | REF.                            | M.L. | COM / COL | 1        | 2        | 3        | 4        | 5        | L1       | L2       |
|--|---------------------------------|------|-----------|----------|----------|----------|----------|----------|----------|----------|
| 98 x 170 H82   38.58" x 66.93" H32.28" | SERCLI98BTPDBB - SERCLD98BTPDBB | 8    | 1.801,65  | 1.851,24 | 1.950,41 | 2.028,93 | 2.231,40 | 2.545,45 | 2.623,97 | 2.938,02 |

SERENE.

PRICES. PRIX. PRECIOS.

SEAT CUSHION 90 CM. COUSSIN DE L'ASSISE DE 90 CM. COJÍN DE ASIENTO DE 90 CM.

SERENE. Sofas with 1 arm. Canapés avec 1 accoudoir. Sofás con 1 brazo.

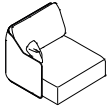

**SERSI95BTPDBB**

95 x 108 H82  
37.40" x 42.52" H32.28"  
IZQ.

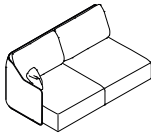

**SERSI185BTPDBB**

185 x 108 H82  
72.83" x 42.52" H32.28"  
IZQ.

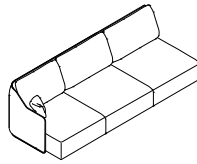

**SERSI275BTPDBB**

275 x 108 H82  
108.27" x 42.52" H32.28"  
IZQ.

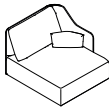

**SERSD95BTPDBB**

95 x 108 H82  
37.40" x 42.52" H32.28"  
DER.

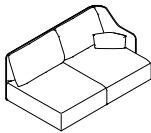

**SERSD185BTPDBB**

185 x 108 H82  
72.83" x 42.52" H32.28"  
DER.

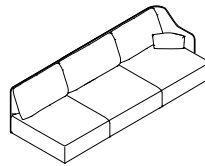

**SERSD275BTPDBB**

275 x 108 H82  
108.27" x 42.52" H32.28"  
DER.

| MEASUREMENT. MESURE. MEDIDA.             | REF.                            | M.L. | COM / COL | 1        | 2        | 3        | 4        | 5        | L1       | L2       |
|--|---------------------------------|------|-----------|----------|----------|----------|----------|----------|----------|----------|
| 95 x 108 H82   37.40" x 42.52" H32.28"   | SERSI95BTPDBB - SERSD95BTPDBB   | 8.5  | 1.483,47  | 1.528,93 | 1.623,97 | 1.702,48 | 1.859,50 | 2.169,42 | 2.231,40 | 2.528,93 |
| 185 x 108 H82   72.83" x 42.52" H32.28"  | SERSI185BTPDBB - SERSD185BTPDBB | 11.5 | 2.297,52  | 2.367,77 | 2.528,93 | 2.657,02 | 2.938,02 | 3.438,02 | 3.561,98 | 4.070,25 |
| 275 x 108 H82   108.27" x 42.52" H32.28" | SERSI275BTPDBB - SERSD275BTPDBB | 16   | 3.165,29  | 3.289,26 | 3.491,74 | 3.681,82 | 4.095,04 | 4.814,05 | 4.962,81 | 5.681,82 |

SERENE. Sofas without arms. Canapés sans accoudoirs. Sofás sin brazo.

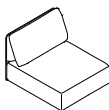

**SERS090BTPD**

90 x 108 H82  
35.43" x 42.52" H32.28"

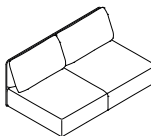

**SERS0180BTPD**

180 x 108 H82  
70.87" x 42.52" H32.28"

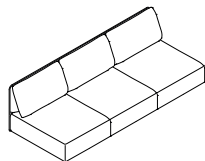

**SERS0270BTPD**

270 x 108 H82  
106.30" x 42.52" H32.28"

| MEASUREMENT. MESURE. MEDIDA.             | REF.         | M.L. | COM / COL | 1        | 2        | 3        | 4        | 5        | L1       | L2       |
|--|--------------|------|-----------|----------|----------|----------|----------|----------|----------|----------|
| 90 X 108 H82   35.43" x 42.52" H32.28"   | SERS090BTPD  | 7.5  | 1.285,12  | 1.326,45 | 1.404,96 | 1.483,47 | 1.632,23 | 1.896,69 | 1.958,68 | 2.231,40 |
| 180 x 108 H82   70.87" x 42.52" H32.28"  | SERS0180BTPD | 11   | 2.107,44  | 2.177,69 | 2.297,52 | 2.429,75 | 2.657,02 | 3.115,70 | 3.194,21 | 3.632,23 |
| 270 x 108 H82   106.30" x 42.52" H32.28" | SERS0270BTPD | 15.5 | 2.929,75  | 3.024,79 | 3.202,48 | 3.392,56 | 3.752,07 | 4.392,56 | 4.533,06 | 5.181,82 |

## SERENE.

PRICES. PRIX. PRECIOS.

SEAT CUSHION 90 CM. COUSSIN DE L'ASSISE DE 90 CM. COJÍN DE ASIENTO DE 90 CM.

SERENE. Corner and sofa corner. Angle et canapé angle. Rincón y sofá rincón.

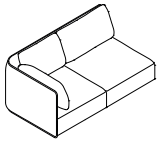

**SERRI194BTPD**

194 x 108 H82  
76.38" x 42.52" H32.28"  
IZQ.

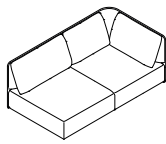

**SERRD194BTPD**

194 x 108 H82  
76.38" x 42.52" H32.28"  
DER.

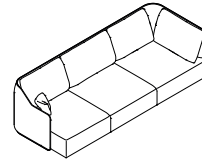

**SERSRI293BTPDBB**

293 x 108 H82  
115.35" x 42.52" H32.28"  
IZQ.

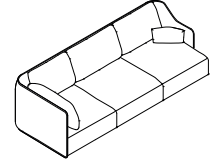

**SERSRD293BTPDBB**

293 x 108 H82  
115.35" x 42.52" H32.28"  
DER.

| MEASUREMENT. MESURE. MEDIDA.             | REF.                              | M.L. | COM / COL | 1        | 2        | 3        | 4        | 5        | L1       | L2       |
|--|-----------------------------------|------|-----------|----------|----------|----------|----------|----------|----------|----------|
| 194 x 108 H82   76.38" x 42.52" H32.28"  | SERRI194BTPD - SERRD194BTPD       | 11.5 | 2.458,68  | 2.545,45 | 2.694,21 | 2.842,98 | 3.157,02 | 3.710,74 | 3.830,58 | 4.392,56 |
| 293 x 108 H82   115.35" x 42.52" H32.28" | SERSRI293BTPDBB - SERSRD293BTPDBB | 16.5 | 3.413,22  | 3.545,45 | 3.780,99 | 4.008,26 | 4.462,81 | 5.285,12 | 5.462,81 | 6.285,12 |

SERENE. Ottomans. Poufs. Ottomans.

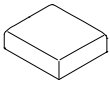

**SERP90BTPD**

90 x 104 H42  
35.43" x 40.94" H16.54"

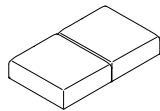

**SERP180BTPD**

180 x 104 H42  
70.87" x 40.94" H16.54"

| MEASUREMENT. MESURE. MEDIDA.            | REF.        | M.L. | COM / COL | 1        | 2        | 3        | 4        | 5        | L1       | L2       |
|---|-------------|------|-----------|----------|----------|----------|----------|----------|----------|----------|
| 90 x 104 H42   35.43" x 40.94" H16.54"  | SERP90BTPD  | 3    | 677,69    | 698,35   | 731,40   | 776,86   | 826,45   | 950,41   | 983,47   | 1.107,44 |
| 180 x 104 H42   70.87" x 40.94" H16.54" | SERP180BTPD | 5    | 1.272,73  | 1.301,65 | 1.363,64 | 1.413,22 | 1.528,93 | 1.731,40 | 1.772,73 | 1.975,21 |

SERENE. Chaise longues.

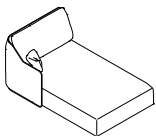

**SERCLI108BTPDBB**

108 x 170 H82  
42.52" x 32.28" H32.28"  
IZQ.

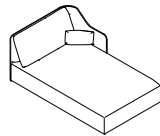

**SERCLD108BTPDBB**

108 x 170 H82  
42.52" x 32.28" H32.28"  
DER.

| MEASUREMENT. MESURE. MEDIDA.            | REF.                              | M.L. | COM / COL | 1        | 2        | 3        | 4        | 5        | L1       | L2       |
|---|-----------------------------------|------|-----------|----------|----------|----------|----------|----------|----------|----------|
| 108 x 170 H82   42.52" x 32.28" H32.28" | SERCLI108BTPDBB - SERCLD108BTPDBB | 8    | 1.929,75  | 1.983,47 | 2.090,91 | 2.185,95 | 2.388,43 | 2.747,93 | 2.826,45 | 3.185,95 |

# SILENCE.

# SOFA. CANAPÉ. SOFÁ.



Designer  
Mario Ruiz

STYLE. ESTILO.  
Cozy

VERSION. VERSIÓN.  
With H arm. Avec bras H. Con brazo H.

## FEATURES. TRAITS. CARACTERÍSTICAS.

Removable upholstery in seat, back and auxiliary cushions.

Combined wood and metal frame covered with flexible cold shaped polyurethane foam and polyester fibre.

Suspension consisting of fibre glass reinforced plastic slats.

Seat cushions in different polyurethane foam densities, with surface padding in polyester silicone fibre. Back cushions stuffed with polyester silicone fibre. Auxiliary cushions made with polyurethane foam inserts, padded with polyester silicone fibre.

Combined natural oak and metal bases coated in polyester powder paint with a manganese topcoat, with PE stops and felt.

\*Additional features for sofas including the box: Metal box coated in polyester powder paint with a manganese topcoat, with sliding oak top, integrated LED lamp and two USB charges. (HÄFELE - 2x 5 V). The sockets and cables will vary according to the different markets. (Europe, UK, USA)

Two back cushions heights available: Standard (84 cm - 33.07 in) or Premium (94 cm - 37.01 in)

**The high backrest costs an extra 47 euros per unit.**

**Le dossier haut coûte 47 euros de plus par unité.**

**El respaldo alto tiene un coste extra de 47 euros por unidad.**

Tapiserie déhoussable sur les coussins de l'assise, coussins du dossier et coussins auxiliaires.

Châssis avec combinaison métal et bois recouvert de mousse de polyuréthane souple à froid et de fibre de polyester.

Suspension au moyen de lattes renforcées avec de la fibre de verre.

Assise réalisés dans différentes densités de mousse polyuréthane, matelassés en surface avec du fibre de polyester silicone. Coussins du dossier garnis de fibre de polyester silicone. Coussins auxiliaires garnis de mousse polyuréthane, matelassés avec de la fibre de polyester silicone.

Bases métalliques combinées avec chêne naturel recouverts en peinture polyester en poudre finition manganèse avec butées en PE et feutre.

\*Caractéristiques supplémentaires pour les canapés avec boîte: Boîte en métal recouverte de peinture polyester en poudre et d'une couche de finition en manganèse avec dessus en chêne coulissant avec lampe à LED intégrée et deux charges USB. (HÄFELE - 2x 5 V) Les prises et les câbles varieront selon les différentes zones du marché. (Europe, Royaume-Uni, États-Unis)

Deux hauteurs de coussin pour le dossiers disponibles: Standard (84 cm) ou Premium (94 cm)

Tapicería desenfundable en cojines de asiento, cojines de respaldo y cojines auxiliares.

Bastidor combinado de metal y madera recubierto de espuma de poliuretano flexible en frío y fibra de poliéster.

Suspensión mediante lamas de plástico reforzadas con fibra de vidrio.

Cojines de asiento realizados en distintas densidades de espuma poliuretano, acolchado en la superficie con fibra de poliéster siliconada. Cojines de respaldo rellenos de fibra de poliéster siliconada. Cojines auxiliares realizados con inserto de espuma de poliuretano, acolchado con fibra de poliéster siliconada.

Bases metálicas combinadas con roble natural recubiertas en pintura poliéster en polvo acabado manganeso con topes de PE y fieltro.

\*Características técnicas adicionales para los sofás que incorporan el mueble contenedor: Mueble contenedor metálico recubierto en pintura poliéster en polvo acabado manganeso con sobre deslizante y lampara LED integrada en roble natural. Incorpora dos tomas de carga USB. (HÄFELE - 2x5 V) Los enchufes y cables variarán en función de los mercados de destino. (Europa, Reino Unido, EE.UU.)

Dos alturas de respaldo disponibles: Standard (84 cm) o Premium (94 cm)



## SILENCE.

### GENERAL MEASUREMENTS. MESURES GÉNÉRALES. MEDIDAS GENERALES.

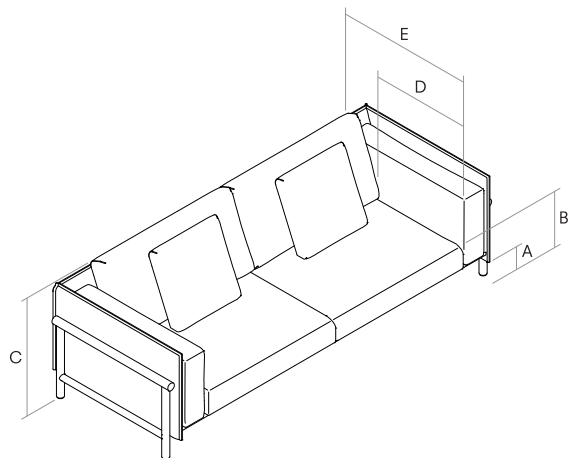

- A. Base height. Hauteur de base. Altura de base. 14 cm - 5.51"
- B. Seat height. Hauteur du siège. Altura de asiento. 40 cm - 15.75"
- C. Backrest height. Hauteur du dossier. Altura de respaldo. 84 cm - 33.07"
- D. Seat depth. Profondeur d'assise. Profundidad de sentada. 62 cm - 24.41"
- E. Depth. Profondeur. Profundidad. 98 cm - 35.04"

### FINISHES. TRAITS. ACABADOS.

Finishes for the metal feet. Finitions des pieds métalliques. Acabados de las patas metálicas.

Polyester powder paint. Peinture polyester en poudre. Pintura poliéster en polvo.



Manganese metal.  
Métal manganèse.  
Metal manganeso.

Finishes for the wooden elements. Finitions des éléments en bois. Acabados de los elementos de madera.

Wood finishes. Finitions bois. Acabado de la madera.



**RN**  
Natural oak.  
Chêne naturel.  
Roble natural.



**RT**  
Dark stained oak.  
Chêne teint foncée.  
Roble teñido oscuro.



**RL**  
Oak painted in black with open-pore finish.  
Chêne laqué noir à pores ouverts.  
Roble lacado negro por abierto.

How to complete the reference. Comment remplir la référence. Cómo completar la referencia.

Example. Exemple. Ejemplo.

1. Select the product. Sélectionner le produit.  
Seleccionar el producto.

2. Select the finish. Sélectionner le finition.  
Seleccionar el acabado.

3. Reference completed. Référence remplie.  
Referencia completada.

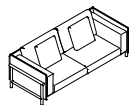

**SILS236**  
236 x 98 H84  
92.91" x 38.58" H33.07"



**RN**  
Natural oak.  
Chêne naturel.  
Roble natural.

**SILS236RN**  
SILENCE sofa, 236cm, natural oak finish.  
Canapé SILENCE, 236 cm, finition chêne naturel.  
Sofá SILENCE, 236 cm, acabado roble natural.

## SILENCE.

PRICES. PRIX. PRECIOS.

### SILENCE. Sofa. Canapé. Sofá.

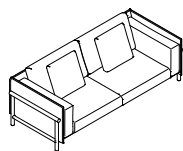

**SILS236**

236 x 98 H84  
92.91" x 38.58" H33.07"

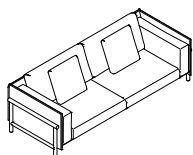

**SILS256**

256 x 98 H84  
100.79" x 38.58" H33.07"

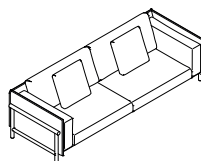

**SILS276**

276 x 98 H84  
108.66" x 38.58" H33.07"

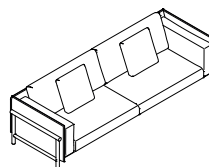

**SILS296**

296 x 98 H84  
116.54" x 38.58" H33.07"

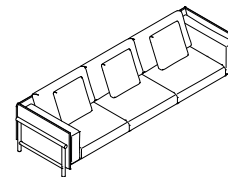

**SILS326**

326 x 98 H84  
128.35" x 38.58" H33.07"

| MEASUREMENT. MESURE. MEDIDA.            | REF.    | M.L. | COM / COL | 1        | 2        | 3        | 4        | 5        | L1       | L2       |
|---|---------|------|-----------|----------|----------|----------|----------|----------|----------|----------|
| 236 x 98 H84   92.91" x 38.58" H33.07"  | SILS236 | 12.5 | 4.041,32  | 4.157,02 | 4.314,05 | 4.471,07 | 4.805,79 | 5.392,56 | 5.524,79 | 6.111,57 |
| 256 x 98 H84   100.79" x 38.58" H33.07" | SILS256 | 12.5 | 4.330,58  | 4.446,28 | 4.595,04 | 4.768,60 | 5.086,78 | 5.673,55 | 5.805,79 | 6.392,56 |
| 256 x 98 H84   100.79" x 38.58" H33.07" | SILS276 | 13   | 4.586,78  | 4.681,82 | 4.859,50 | 5.033,06 | 5.376,03 | 5.995,87 | 6.128,10 | 6.756,20 |
| 296 x 98 H84   116.54" x 38.58" H33.07" | SILS296 | 13.5 | 4.789,26  | 4.892,56 | 5.057,85 | 5.243,80 | 5.603,31 | 6.223,14 | 6.363,64 | 6.995,87 |
| 326 x 98 H84   128.35" x 38.58" H33.07" | SILS326 | 15.5 | 5.144,63  | 5.276,86 | 5.487,60 | 5.690,08 | 6.119,83 | 6.880,17 | 7.049,59 | 7.801,65 |

### SILENCE. Auxiliar cushions. Coussins auxiliares. Cojines auxiliares.



**SILC065**

65 x 45  
25.59" x 17.72"

Recommended. Recommandé.

Recomendado.

SILS236

SILS256

SILS326

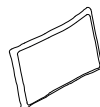

**SILC085**

85 x 45  
33.46" x 17.72"

Recommended. Recommandé.

Recomendado.

SILS276

SILS296

| MEASUREMENT. MESURE. MEDIDA. | REF.    | M.L. | COM / COL | 1      | 2      | 3      | 4      | 5      | L1     | L2     |
|------------------------------|---------|------|-----------|--------|--------|--------|--------|--------|--------|--------|
| 65 x 45   25.59" x 17.72"    | SILC065 | 1    | 128,10    | 128,10 | 136,36 | 144,63 | 169,42 | 198,35 | 214,88 | 239,67 |
| 85 x 45   33.46" x 17.72"    | SILC085 | 1    | 169,42    | 177,69 | 198,35 | 223,14 | 247,93 | 309,92 | 326,45 | 388,43 |

## SILENCE.

### PRICES. PRIX. PRECIOS.

SILENCE. Sofas with 1 arm and terminal box with integrated LED lamp and USB point. Canapés avec 1 accoudoir et boîte terminal avec lampe LED et prise USB intégrée. Sofás con 1 brazo y mueble contenedor terminal con lámpara LED y toma USB integrada.

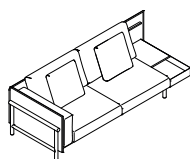

**SILSI251MTL**

251 x 98 H84  
98.82" x 38.58" H33.07"  
IZQ.

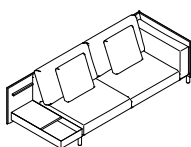

**SILSD251MTL**

251 x 98 H84  
98.82" x 38.58" H33.07"  
DER.

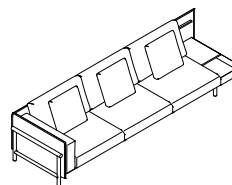

**SILSI341MTL**

341 x 98 H84  
134.25" x 38.58" H33.07"  
IZQ.

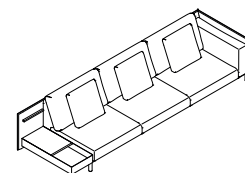

**SILSD341MTL**

341 x 98 H84  
134.25" x 38.58" H33.07"  
DER.

| MEASUREMENT. MESURE. MEDIDA.            | REF.                      | M.L. | COM / COL | 1        | 2        | 3        | 4        | 5        | L1       | L2       |
|---|---------------------------|------|-----------|----------|----------|----------|----------|----------|----------|----------|
| 251 x 98 H84   98.82" x 38.58" H33.07"  | SILSI251MTL - SILSD251MTL | 10.5 | 5.157,02  | 5.243,80 | 5.376,03 | 5.504,13 | 5.768,60 | 6.243,80 | 6.355,37 | 6.830,58 |
| 341 x 98 H84   134.25" x 38.58" H33.07" | SILSI341MTL - SILSD341MTL | 13.5 | 6.260,33  | 6.371,90 | 6.557,85 | 6.731,40 | 7.090,91 | 7.756,20 | 7.896,69 | 8.553,72 |

SILENCE. Sofas with 1 arm and terminal box. Canapés avec 1 accoudoir et boîte terminal. Sofás con 1 brazo y mueble contenedor terminal.

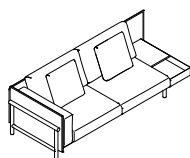

**SILSI251MT**

251 x 98 H84  
98.82" x 38.58" H33.07"  
IZQ.

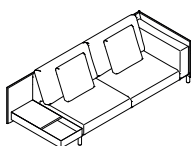

**SILSD251MT**

251 x 98 H84  
98.82" x 38.58" H33.07"  
DER.

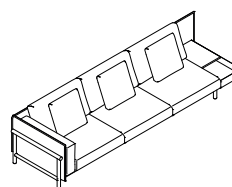

**SILSI341MT**

341 x 98 H84  
134.25" x 38.58" H33.07"  
IZQ.

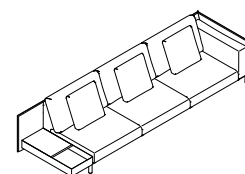

**SILSD341MT**

341 x 98 H84  
134.25" x 38.58" H33.07"  
DER.

| MEASUREMENT. MESURE. MEDIDA.            | REF.                    | M.L. | COM / COL | 1        | 2        | 3        | 4        | 5        | L1       | L2       |
|---|-------------------------|------|-----------|----------|----------|----------|----------|----------|----------|----------|
| 251 x 98 H84   98.82" x 38.58" H33.07"  | SILSI251MT - SILSD251MT | 10   | 4.752,07  | 4.838,84 | 4.971,07 | 5.103,31 | 5.376,03 | 5.847,11 | 5.962,81 | 6.450,41 |
| 341 x 98 H84   134.25" x 38.58" H33.07" | SILSI341MT - SILSD341MT | 13.5 | 5.863,64  | 5.979,34 | 6.161,16 | 6.338,84 | 6.714,88 | 7.355,37 | 7.504,13 | 8.152,89 |

SILENCE. Sofas with 1 arm. Canapés avec 1 accoudoir. Sofás con 1 brazo.

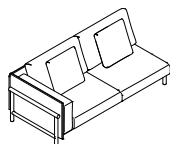

**SILSI208**

208 x 98 H84  
81.89" x 38.58" H33.07"  
IZQ.

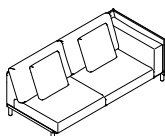

**SILSD208**

208 x 98 H84  
81.89" x 38.58" H33.07"  
DER.

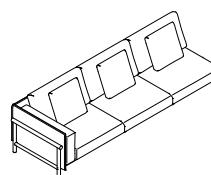

**SILSI298**

298 x 98 H84  
117.32" x 38.58" H33.07"  
IZQ.

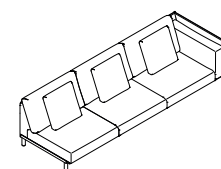

**SILSD298**

298 x 98 H84  
117.32" x 38.58" H33.07"  
DER.

| MEASUREMENT. MESURE. MEDIDA.            | REF.                | M.L. | COM / COL | 1        | 2        | 3        | 4        | 5        | L1       | L2       |
|---|---------------------|------|-----------|----------|----------|----------|----------|----------|----------|----------|
| 208 x 98 H84   81.89" x 38.58" H33.07"  | SILSI208 - SILSD208 | 10   | 3.264,46  | 3.351,24 | 3.483,47 | 3.611,57 | 3.867,77 | 4.338,84 | 4.446,28 | 4.917,36 |
| 298 x 98 H84   117.32" x 38.58" H33.07" | SILSI298 - SILSD298 | 13.5 | 4.330,58  | 4.438,02 | 4.611,57 | 4.797,52 | 5.157,02 | 5.793,39 | 5.933,88 | 6.582,64 |

## SILENCE.

### PRICES. PRIX. PRECIOS.

SILENCE. Sofas with 1 arm and box with integrated LED lamp and USB point. Canapés avec 1 accoudoir et boîte avec lampe LED et prise USB intégrée. Sofás con 1 brazo y mueble contenedor con lámpara LED y toma USB integrada.

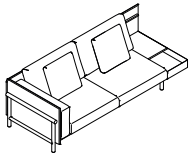

**SILSI248ML**

248 x 98 H84  
97.64" x 38.58" H33.07"  
IZQ.

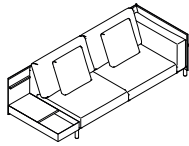

**SILSD248ML**

248 x 98 H84  
97.64" x 38.58" H33.07"  
DER.

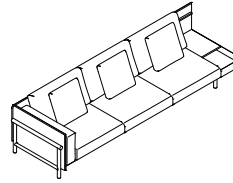

**SILSI338ML**

338 x 98 H84  
133.07" x 38.58" H33.07"  
IZQ.

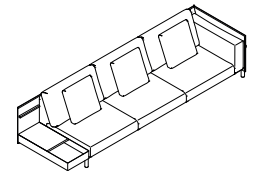

**SILSD338ML**

338 x 98 H84  
133.07" x 38.58" H33.07"  
DER.

| MEASUREMENT. MESURE. MEDIDA.            | REF.                    | M.L. | COM / COL | 1        | 2        | 3        | 4        | 5        | L1       | L2       |
|---|-------------------------|------|-----------|----------|----------|----------|----------|----------|----------|----------|
| 248 x 98 H84   97.64" x 38.58" H33.07"  | SILSI248ML - SILSD248ML | 10.5 | 5.157,02  | 5.243,80 | 5.376,03 | 5.504,13 | 5.768,60 | 6.243,80 | 6.355,37 | 6.830,58 |
| 338 x 98 H84   133.07" x 38.58" H33.07" | SILSI338ML - SILSD338ML | 13.5 | 6.260,33  | 6.371,90 | 6.557,85 | 6.731,40 | 7.090,91 | 7.756,20 | 7.896,69 | 8.553,72 |

SILENCE. Sofas with 1 arm and box. Canapés avec 1 accoudoir et boîte. Sofás con 1 brazo y mueble contenedor.

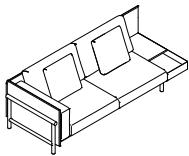

**SILSI248M**

248 x 98 H84  
97.64" x 38.58" H33.07"  
IZQ.

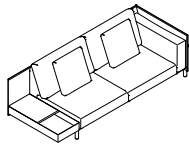

**SILSD248M**

248 x 98 H84  
97.64" x 38.58" H33.07"  
DER.

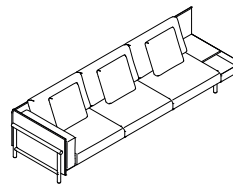

**SILSI338M**

338 x 98 H84  
133.07" x 38.58" H33.07"  
IZQ.

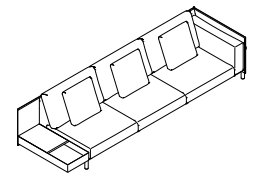

**SILSD338M**

338 x 98 H84  
133.07" x 38.58" H33.07"  
DER.

| MEASUREMENT. MESURE. MEDIDA.            | REF.                  | M.L. | COM / COL | 1        | 2        | 3        | 4        | 5        | L1       | L2       |
|---|-----------------------|------|-----------|----------|----------|----------|----------|----------|----------|----------|
| 248 x 98 H84   97.64" x 38.58" H33.07"  | SILSI248M - SILSD248M | 10.5 | 4.752,07  | 4.838,84 | 4.971,07 | 5.103,31 | 5.376,03 | 5.847,11 | 5.962,81 | 6.450,41 |
| 338 x 98 H84   133.07" x 38.58" H33.07" | SILSI338M - SILSD338M | 13.5 | 5.863,64  | 5.979,34 | 6.161,16 | 6.338,84 | 6.714,88 | 7.355,37 | 7.504,13 | 8.152,89 |

SILENCE. Sofas without arms. Canapés sans accoudoirs. Sofás sin brazos.

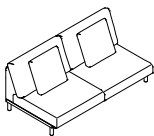

**SILS0180**

180 x 98 H84  
70.87" x 38.58" H33.07"

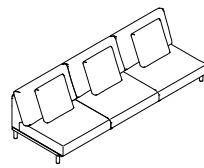

**SILS0270**

270 x 98 H84  
106.30" x 38.58" H33.07"

| MEASUREMENT. MESURE. MEDIDA.            | REF.     | M.L. | COM / COL | 1        | 2        | 3        | 4        | 5        | L1       | L2       |
|---|----------|------|-----------|----------|----------|----------|----------|----------|----------|----------|
| 180 x 98 H84   70.87" x 38.58" H33.07"  | SILS0180 | 8    | 2.876,03  | 2.929,75 | 3.037,19 | 3.140,50 | 3.334,71 | 3.710,74 | 3.772,73 | 4.140,50 |
| 270 x 98 H84   106.30" x 38.58" H33.07" | SILS0270 | 11.5 | 3.797,52  | 3.892,56 | 4.041,32 | 4.190,08 | 4.491,74 | 5.033,06 | 5.144,63 | 5.690,08 |

## SILENCE.

### PRICES. PRIX. PRECIOS.

SILENCE. Sofas without arms and box with integrated LED lamp and USB point. Canapés sans accoudoirs et boîte avec lampe LED et prise USB intégrée. Sofás sin brazo y mueble contenedor con lámpara LED y toma USB integrada.

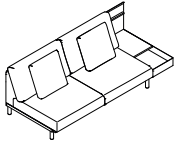

**SILS0D220ML**

220 x 98 H84  
86.61" x 38.58" H33.07"  
DER.

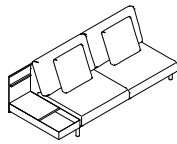

**SILS0I220ML**

220 x 98 H84  
86.61" x 38.58" H33.07"  
IZQ.

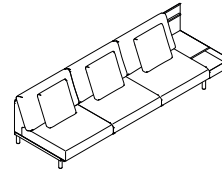

**SILS0D310ML**

310 x 98 H84  
122.05" x 38.58" H33.07"  
DER.

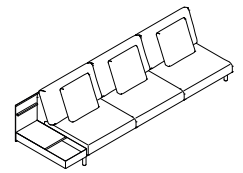

**SILS0I310ML**

310 x 98 H84  
122.05" x 38.58" H33.07"  
IZQ.

| MEASUREMENT. MESURE. MEDIDA.            | REF.                      | M.L. | COM / COL | 1        | 2        | 3        | 4        | 5        | L1       | L2       |
|---|---------------------------|------|-----------|----------|----------|----------|----------|----------|----------|----------|
| 220 x 98 H84   86.61" x 38.58" H33.07"  | SILS0I220ML - SILS0D220ML | 7.5  | 4.322,31  | 4.384,30 | 4.479,34 | 4.578,51 | 4.776,86 | 5.128,10 | 5.198,35 | 5.549,59 |
| 310 x 98 H84   122.05" x 38.58" H33.07" | SILS0I310ML - SILS0D310ML | 13   | 5.673,55  | 5.776,86 | 5.962,81 | 6.144,63 | 6.504,13 | 7.161,16 | 7.301,65 | 7.966,94 |

SILENCE. Sofas without arms and box. Canapés sans accoudoirs et boîte. Sofás sin brazo y mueble contenedor.

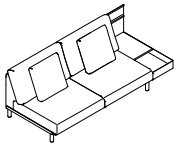

**SILS0D220M**

220 x 98 H84  
86.61" x 38.58" H33.07"  
DER.

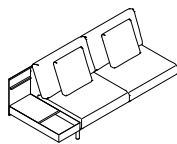

**SILS0I220M**

220 x 98 H84  
86.61" x 38.58" H33.07"  
IZQ.

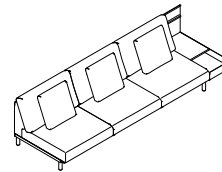

**SILS0D310M**

310 x 98 H84  
122.05" x 38.58" H33.07"  
DER.

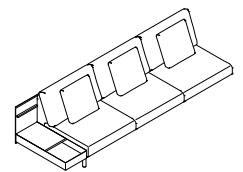

**SILS0I310M**

310 x 98 H84  
122.05" x 38.58" H33.07"  
IZQ.

| MEASUREMENT. MESURE. MEDIDA.            | REF.                    | M.L. | COM / COL | 1        | 2        | 3        | 4        | 5        | L1       | L2       |
|---|-------------------------|------|-----------|----------|----------|----------|----------|----------|----------|----------|
| 220 x 98 H84   86.61" x 38.58" H33.07"  | SILS0I220M - SILS0D220M | 7.5  | 3.929,75  | 3.991,74 | 4.086,78 | 4.190,08 | 4.376,03 | 4.727,27 | 4.814,05 | 5.165,29 |
| 310 x 98 H84   122.05" x 38.58" H33.07" | SILS0I310M - SILS0D310M | 13   | 5.276,86  | 5.392,56 | 5.566,12 | 5.752,07 | 6.111,57 | 6.760,33 | 6.909,09 | 7.553,72 |

SILENCE. Corner. Angle. Rincón.

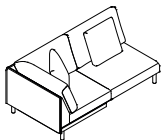

**SILRI188**

188 x 98 H84  
74.02" x 38.58" H33.07"  
IZQ.

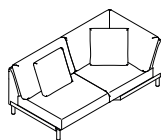

**SILRD188**

188 x 98 H84  
74.02" x 38.58" H33.07"  
DER.

| MEASUREMENT. MESURE. MEDIDA.           | REF.                | M.L. | COM / COL | 1        | 2        | 3        | 4        | 5        | L1       | L2       |
|--|---------------------|------|-----------|----------|----------|----------|----------|----------|----------|----------|
| 188 x 98 H84   74.02" x 38.58" H33.07" | SILRI188 - SILRD188 | 10.5 | 3.194,21  | 3.272,73 | 3.404,96 | 3.545,45 | 3.805,79 | 4.297,52 | 4.392,56 | 4.876,03 |

## SILENCE.

PRICES. PRIX. PRECIOS.

SILENCE. Sofa corner. Canapé angles. Sofá rincón.

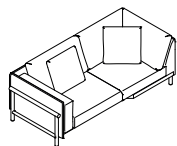

**SILSRI216**

216 x 98 H84  
85.04" x 38.58" H33.07"  
IZQ.

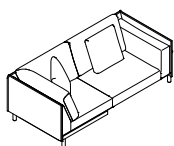

**SILSRD216**

216 x 98 H84  
85.04" x 38.58" H33.07"  
DER.

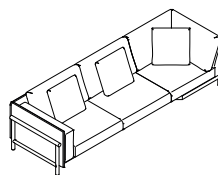

**SILSRI306**

306 x 98 H84  
120.47" x 38.58" H33.07"  
IZQ.

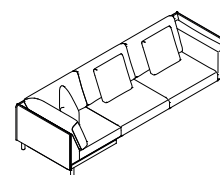

**SILSRD306**

306 x 98 H84  
120.47" x 38.58" H33.07"  
DER.

| MEASUREMENT. MESURE. MEDIDA.            | REF.                  | M.L. | COM / COL | 1        | 2        | 3        | 4        | 5        | L1       | L2       |
|---|-----------------------|------|-----------|----------|----------|----------|----------|----------|----------|----------|
| 216 x 98 H84   85.04" x 38.58" H33.07"  | SILSRI216 - SILSRD216 | 12.5 | 3.735,54  | 3.814,05 | 3.946,28 | 4.086,78 | 4.351,24 | 4.838,84 | 4.938,02 | 5.417,36 |
| 306 x 98 H84   120.47" x 38.58" H33.07" | SILSRI306 - SILSRD306 | 15.5 | 4.917,36  | 5.049,59 | 5.260,33 | 5.479,34 | 5.900,83 | 6.669,42 | 6.838,84 | 7.590,91 |

SILENCE. Corner with terminal box with integrated LED lamp and USB point. Angle avec boîte terminal avec lampe LED et prise USB intégrée. Rincón con mueble contenedor terminal con lámpara LED y toma USB integrada.

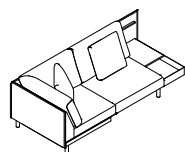

**SILRI231MTL**

231 x 98 H84  
90.94" x 38.58" H33.07"  
IZQ.

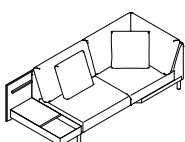

**SILRD231MTL**

231 x 98 H84  
90.94" x 38.58" H33.07"  
DER.

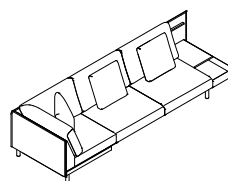

**SILRI321MTL**

321 x 98 H84  
126.38" x 38.58" H33.07"  
IZQ.

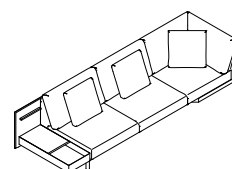

**SILRD321MTL**

321 x 98 H84  
126.38" x 38.58" H33.07"  
DER.

| MEASUREMENT. MESURE. MEDIDA.            | REF.                      | M.L. | COM / COL | 1        | 2        | 3        | 4        | 5        | L1       | L2       |
|---|---------------------------|------|-----------|----------|----------|----------|----------|----------|----------|----------|
| 231 x 98 H84   90.94" x 38.58" H33.07"  | SILRI231MTL - SILRD231MTL | 11.5 | 4.628,10  | 4.706,61 | 4.838,84 | 4.979,34 | 5.243,80 | 5.731,40 | 5.830,58 | 6.309,92 |
| 321 x 98 H84   126.38" x 38.58" H33.07" | SILRI321MTL - SILRD321MTL | 13.5 | 6.090,91  | 6.190,08 | 6.347,11 | 6.504,13 | 6.818,18 | 7.380,17 | 7.504,13 | 8.061,98 |

SILENCE. Corner with terminal box. Angle avec boîte terminal. Rincón con mueble contenedor terminal.

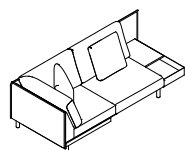

**SILRI231MT**

231 x 98 H84  
90.94" x 38.58" H33.07"  
IZQ.

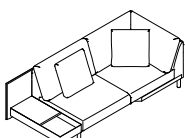

**SILRD231MT**

231 x 98 H84  
90.94" x 38.58" H33.07"  
DER.

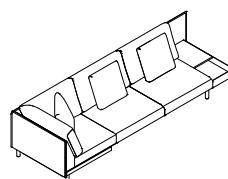

**SILRI321MT**

321 x 98 H84  
126.38" x 38.58" H33.07"  
IZQ.

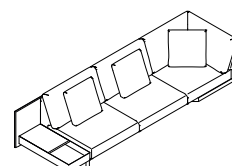

**SILRD321MT**

321 x 98 H84  
126.38" x 38.58" H33.07"  
DER.

| MEASUREMENT. MESURE. MEDIDA.            | REF.                    | M.L. | COM / COL | 1        | 2        | 3        | 4        | 5        | L1       | L2       |
|---|-------------------------|------|-----------|----------|----------|----------|----------|----------|----------|----------|
| 231 x 98 H84   90.94" x 38.58" H33.07"  | SILRI231MT - SILRD231MT | 11.5 | 4.235,54  | 4.314,05 | 4.446,28 | 4.586,78 | 4.847,11 | 5.338,84 | 5.433,88 | 5.917,36 |
| 321 x 98 H84   126.38" x 38.58" H33.07" | SILRI321MT - SILRD321MT | 13.5 | 5.698,35  | 5.793,39 | 5.954,55 | 6.111,57 | 6.425,62 | 6.987,60 | 7.107,44 | 7.669,42 |

## SILENCE.

### PRICES. PRIX. PRECIOS.

SILENCE. Sofa without arms and terminal ottoman. Canapé sans accoudoirs et pouf terminal. Sofá sin brazos con ottoman terminal.

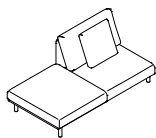

**SILSPI180**

180 x 98 H84  
70.87" x 38.58" H33.07"  
IZQ.

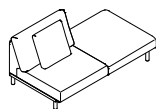

**SILSPD180**

180 x 98 H84  
70.87" x 38.58" H33.07"  
DER.

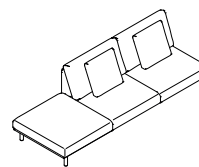

**SILSPI270**

270 x 98 H84  
106.30" x 38.58" H33.07"  
IZQ.

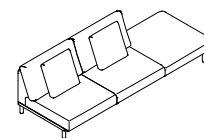

**SILSPD270**

270 x 98 H84  
106.30" x 38.58" H33.07"  
DER.

| MEASUREMENT. MESURE. MEDIDA.            | REF.                  | M.L. | COM / COL | 1        | 2        | 3        | 4        | 5        | L1       | L2       |
|---|-----------------------|------|-----------|----------|----------|----------|----------|----------|----------|----------|
| 180 x 98 H84   70.87" x 38.58" H33.07"  | SILSPI180 - SILSPD180 | 6    | 2.772,73  | 2.818,18 | 2.896,69 | 2.975,21 | 3.140,50 | 3.413,22 | 3.483,47 | 3.764,46 |
| 270 x 98 H84   106.30" x 38.58" H33.07" | SILSPI270 - SILSPD270 | 9    | 3.842,98  | 3.913,22 | 4.033,06 | 4.157,02 | 4.400,83 | 4.847,11 | 4.954,55 | 5.400,83 |

SILENCE. Corner with terminal ottoman. Angle avec pouf terminal. Rincón con ottoman terminal.

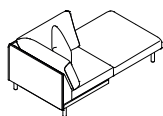

**SILRPI188**

188 x 98 H84  
74.02" x 38.58" H33.07"  
IZQ.

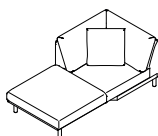

**SILRPD188**

188 x 98 H84  
74.02" x 38.58" H33.07"  
DER.

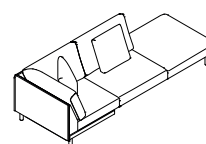

**SILRPI278**

278 x 98 H84  
109.45" x 38.58" H33.07"  
IZQ.

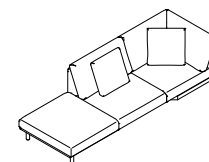

**SILRPD278**

278 x 98 H84  
109.45" x 38.58" H33.07"  
DER.

| MEASUREMENT. MESURE. MEDIDA.            | REF.                  | M.L. | COM / COL | 1        | 2        | 3        | 4        | 5        | L1       | L2       |
|---|-----------------------|------|-----------|----------|----------|----------|----------|----------|----------|----------|
| 188 x 98 H84   74.02" x 38.58" H33.07"  | SILRPI188 - SILRPD188 | 9.5  | 3.462,81  | 3.508,26 | 3.586,78 | 3.665,29 | 3.830,58 | 4.103,31 | 4.173,55 | 4.454,55 |
| 278 x 98 H84   109.45" x 38.58" H33.07" | SILRPI278 - SILRPD278 | 11.5 | 4.272,73  | 4.359,50 | 4.516,53 | 4.681,82 | 4.987,60 | 5.557,85 | 5.673,55 | 6.243,80 |

SILENCE. Ottomans. Poufs. Ottomans.

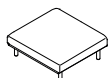

**SILP90**

90 x 98 H40  
35.43" x 38.58" H15.75"

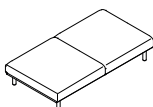

**SILP180**

180 x 98 H40  
70.87" x 38.58" H15.75"

| MEASUREMENT. MESURE. MEDIDA.           | REF.    | M.L. | COM / COL | 1        | 2        | 3        | 4        | 5        | L1       | L2       |
|--|---------|------|-----------|----------|----------|----------|----------|----------|----------|----------|
| 90 x 98 H40   35.43" x 38.58" H15.75"  | SILP90  | 2.5  | 1.710,74  | 1.731,40 | 1.747,93 | 1.772,73 | 1.818,18 | 1.904,96 | 1.942,15 | 2.028,93 |
| 180 x 98 H40   70.87" x 38.58" H15.75" | SILP180 | 5    | 2.413,22  | 2.450,41 | 2.508,26 | 2.578,51 | 2.702,48 | 2.929,75 | 2.983,47 | 3.210,74 |

## SILENCE.

PRICES. PRIX. PRECIOS.

SILENCE. Chaise longue.

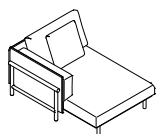

### SILCLI118

118 x 158 H84  
46.46" x 62.20" H33.07"  
IZQ.

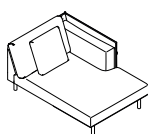

### SILCLD118

118 x 158 H84  
46.46" x 62.20" H33.07"  
DER.

| MEASUREMENT. MESURE. MEDIDA.            | REF.                  | M.L. | COM / COL | 1        | 2        | 3        | 4        | 5        | L1       | L2       |
|---|-----------------------|------|-----------|----------|----------|----------|----------|----------|----------|----------|
| 118 x 158 H84   46.46" x 62.20" H33.07" | SILCLI118 - SILCLD118 | 8    | 3.194,21  | 3.256,20 | 3.367,77 | 3.475,21 | 3.673,55 | 4.070,25 | 4.140,50 | 4.516,53 |

SILENCE. Island with or without arms. Île avec ou sans accoudoirs. Isla con o sin brazos.



### SILII118

118 x 118 H84  
46.46" x 46.46" H33.07"  
IZQ.

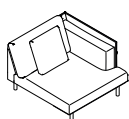

### SILID118

118 x 118 H84  
46.46" x 46.46" H33.07"  
DER.

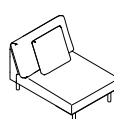

### SILI090

90 x 118 H84  
35.43" x 46.46" H33.07"

| MEASUREMENT. MESURE. MEDIDA.            | REF.                | M.L. | COM / COL | 1        | 2        | 3        | 4        | 5        | L1       | L2       |
|---|---------------------|------|-----------|----------|----------|----------|----------|----------|----------|----------|
| 118 x 118 H84   46.46" x 46.46" H33.07" | SILII118 - SILID118 | 7    | 2.888,43  | 2.929,75 | 3.024,79 | 3.115,70 | 3.000,00 | 3.603,31 | 3.665,29 | 3.991,74 |
| 90 x 118 H84   35.43" x 46.46" H33.07"  | SILI090             | 5    | 2.107,44  | 2.140,50 | 2.210,74 | 2.264,46 | 2.404,96 | 2.640,50 | 2.694,21 | 2.921,49 |





# SILENCE.

# SOFA. CANAPÉ. SOFÁ.



Designer  
Mario Ruiz

STYLE. ESTILO.  
Cozy

VERSION. VERSIÓN.  
With legs. Avec jambes. Con patas.

## FEATURES. TRAITS. CARACTERÍSTICAS.

Removable upholstery in seat, back and auxiliary cushions.

Combined wood and metal frame covered with flexible cold shaped polyurethane foam and polyester fibre.

Suspension consisting of fibre glass reinforced plastic slats.

Seat cushions in different polyurethane foam densities, with surface padding in polyester silicone fibre. Back cushions stuffed with polyester silicone fibre. Auxiliary cushions made with polyurethane foam inserts, padded with polyester silicone fibre.

Metal bases coated in polyester powder paint with a manganese topcoat, with PE stops and felt.

\*Additional features for sofas including the box: Metal box coated in polyester powder paint with a manganese topcoat, sliding oak top with integrated LED lamp and two USB charges. (HÄFELE - 2x 5 V). The sockets and cables will vary according to the different markets. (Europe, UK, USA)

Two back cushions heights available: Standard (84 cm - 33.07 in) or Premium (94 cm - 37.01 in)

**The high backrest costs an extra 47 euros per unit.**

**Le dossier haut coûte 47 euros de plus par unité.**

**El respaldo alto tiene un coste extra de 47 euros por unidad.**

Tapiserie déhoussable sur les coussins de l'assise, coussins du dossier et coussins auxiliaires.

Châssis avec combinaison métal et bois recouvert de mousse de polyuréthane souple à froid et de fibre de polyester.

Suspension au moyen de lattes renforcées avec de la fibre de verre.

Assise réalisés dans différentes densités de mousse polyuréthane, matelassés en surface avec du fibre de polyester silicone. Coussins du dossier garnis de fibre de polyester silicone. Coussins auxiliaires garnis de mousse polyuréthane, matelassés avec de la fibre de polyester silicone.

Bases métalliques recouverts en peinture polyester en poudre finition manganèse avec butées en PE et feutre.

\*Caractéristiques supplémentaires pour les canapés avec boîte : Boîte en métal recouverte de peinture polyester en poudre et d'une couche de finition en manganèse avec dessus en chêne coulissant avec lampe à LED intégrée et deux charges USB. (HÄFELE - 2x 5 V) Les prises et les câbles varieront selon les différentes zones du marché. (Europe, Royaume-Uni, États-Unis)

Deux hauteurs de coussin pour le dossiers disponibles : Standard (84 cm) ou Premium (94 cm)

Tapicería desenfundable en cojines de asiento, cojines de respaldo y cojines auxiliares.

Bastidor combinado de metal y madera recubierto de espuma de poliuretano flexible en frío y fibra de poliéster.

Suspensión mediante lamas de plástico reforzadas con fibra de vidrio.

Cojines de asiento realizados en distintas densidades de espuma poliuretano, acolchado en la superficie con fibra de poliéster siliconada. Cojines de respaldo rellenos de fibra de poliéster siliconada. Cojines auxiliares realizados con inserto de espuma de poliuretano, acolchado con fibra de poliéster siliconada.

Bases metálicas recubiertas en pintura poliéster en polvo acabado manganeso con topes de PE y fieltro.

\*Características técnicas adicionales para los sofás que incorporan el mueble contenedor: Mueble contenedor metálico recubierto en pintura poliéster en polvo acabado manganeso con sobre deslizante y lampara LED integrada en roble natural. Incorpora dos tomas de carga USB. (HÄFELE - 2x5 V) Los enchufes y cables variarán en función de los mercados de destino. (Europa, Reino Unido, EE.UU.)

Dos alturas de respaldo disponibles: Standard (84 cm) o Premium (94 cm)

## SILENCE.

### GENERAL MEASUREMENTS. MESURES GÉNÉRALES. MEDIDAS GENERALES.

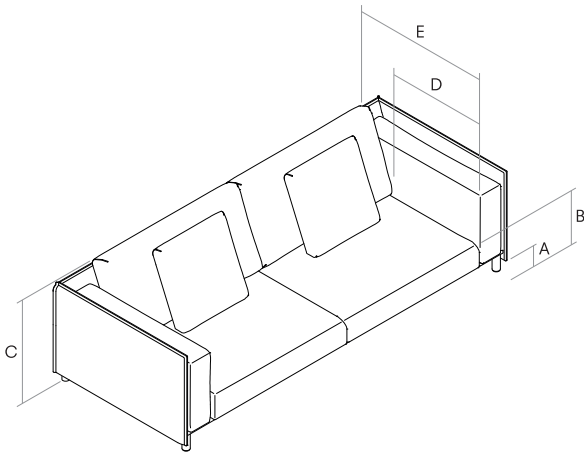

- A. Base height. Hauteur de base. Altura de base. 14 cm - 5.51"
- B. Seat height. Hauteur du siège. Altura de asiento. 40 cm - 15.75"
- C. Backrest height. Hauteur du dossier. Altura de respaldo. 84 cm - 33.07"
- D. Seat depth. Profondeur d'assise. Profundidad de sentada. 62 cm - 24.41"
- E. Depth. Profondeur. Profundidad. 98 cm - 35.04"

### FINISHES. TRAITS. ACABADOS.

Finishes for the metal feet. Finitions des pieds métalliques. Acabados de las patas metálicas.

Polyester powder paint. Peinture polyester en poudre. Pintura poliéster en polvo.



Manganese metal.  
Métal manganèse.  
Metal manganeso.

Finishes for the wooden elements. Finitions des éléments en bois. Acabados de los elementos de madera.

Wood finishes. Finitions bois. Acabado de la madera.



**RN**  
Natural oak.  
Chêne naturel.  
Roble natural.



**RT**  
Dark stained oak.  
Chêne teint foncée.  
Roble teñido oscuro.



**RL**  
Oak painted in black with open-pore finish.  
Chêne laqué noir à pores ouverts.  
Roble lacado negro por abierto.

How to complete the reference. Comment remplir la référence. Cómo completar la referencia.

Example. Exemple. Ejemplo.

1. Select the product. Sélectionner le produit.  
Seleccionar el producto.

2. Select the finish. Sélectionner le finition.  
Seleccionar el acabado.

3. Reference completed. Référence remplie.  
Referencia completada.

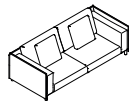

**SILS226**  
226 x 98 H84  
88.98" x 38.58" H33.07"



**RN**  
Natural oak.  
Chêne naturel.  
Roble natural.

**SILS226RN**  
SILENCE sofa, 226cm, natural oak finish.  
Canapé SILENCE, 226 cm, finition chêne naturel.  
Sofá SILENCE, 226 cm, acabado roble natural.

## SILENCE.

PRICES. PRIX. PRECIOS.

### SILENCE. Sofa. Canapé. Sofá.

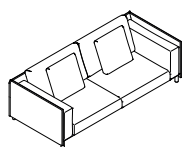

**SILS226**

226 x 98 H84  
88.98" x 38.58" H33.07"

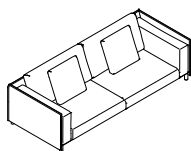

**SILS246**

246 x 98 H84  
96.85" x 38.58" H33.07"

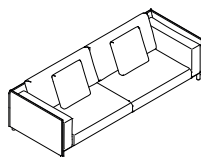

**SILS266**

266 x 98 H84  
104.72" x 38.58" H33.07"

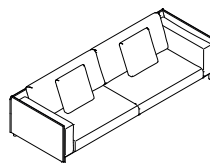

**SILS286**

286 x 98 H84  
112.60" x 38.58" H33.07"

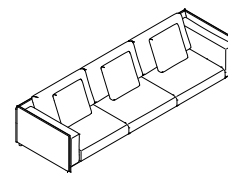

**SILS316**

316 x 98 H84  
124.41" x 38.58" H33.07"

| MEASUREMENT. MESURE. MEDIDA.            | REF.    | M.L. | COM / COL | 1        | 2        | 3        | 4        | 5        | L1       | L2       |
|---|---------|------|-----------|----------|----------|----------|----------|----------|----------|----------|
| 226 x 98 H84   88.98" x 38.58" H33.07"  | SILS226 | 12.5 | 3.623,97  | 3.719,01 | 3.876,03 | 4.041,32 | 4.367,77 | 4.954,55 | 5.086,78 | 5.673,55 |
| 246 x 98 H84   96.85" x 38.58" H33.07"  | SILS246 | 12.5 | 3.900,83  | 4.008,26 | 4.165,29 | 4.330,58 | 4.665,29 | 5.252,07 | 5.376,03 | 5.962,81 |
| 266 x 98 H84   104.72" x 38.58" H33.07" | SILS266 | 13   | 4.148,76  | 4.252,07 | 4.429,75 | 4.595,04 | 4.946,28 | 5.557,85 | 5.698,35 | 6.322,31 |
| 286 x 98 H84   112.60" x 38.58" H33.07" | SILS286 | 13.5 | 4.351,24  | 4.462,81 | 4.628,10 | 4.805,79 | 5.165,29 | 5.785,12 | 5.925,62 | 6.566,12 |
| 316 x 98 H84   124.41" x 38.58" H33.07" | SILS316 | 15.5 | 4.719,01  | 4.838,84 | 5.057,85 | 5.268,60 | 5.690,08 | 6.450,41 | 6.619,83 | 7.380,17 |

### SILENCE. Auxiliar cushions. Cousins auxiliares. Cojines auxiliares.



**SILC065**

65 x 45  
25.59" x 17.72"

Recommended. Recommandé.

Recomendado.

SILS226

SILS246

SILS316

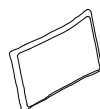

**SILC085**

85 x 45  
33.46" x 17.72"

Recommended. Recommandé.

Recomendado.

SILS266

SILS286

| MEASUREMENT. MESURE. MEDIDA. | REF.    | M.L. | COM / COL | 1      | 2      | 3      | 4      | 5      | L1     | L2     |
|------------------------------|---------|------|-----------|--------|--------|--------|--------|--------|--------|--------|
| 65 x 45   25.59" x 17.72"    | SILC065 | 1    | 128,10    | 128,10 | 136,36 | 144,63 | 169,42 | 198,35 | 214,88 | 239,67 |
| 85 x 45   33.46" x 17.72"    | SILC085 | 1    | 169,42    | 177,69 | 198,35 | 223,14 | 247,93 | 309,92 | 326,45 | 388,43 |

## SILENCE.

### PRICES. PRIX. PRECIOS.

SILENCE. Sofas with 1 arm and terminal box with integrated LED lamp and USB point. Canapés avec 1 accoudoir et boîte terminal avec lampe LED et prise USB intégrée. Sofás con 1 brazo y mueble contenedor terminal con lámpara LED y toma USB integrada.

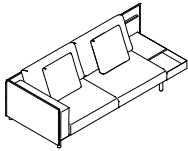

**SILSI246MTL**

246 x 98 H84  
96.85" x 38.58" H33.07"  
IZQ.

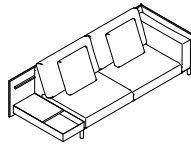

**SILSD246MTL**

246 x 98 H84  
96.85" x 38.58" H33.07"  
DER.

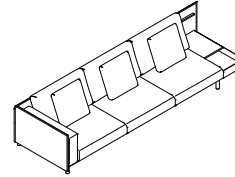

**SILSI336MTL**

336 x 98 H84  
132.28" x 38.58" H33.07"  
IZQ.

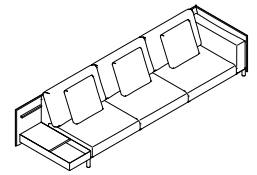

**SILSD336MTL**

336 x 98 H84  
132.28" x 38.58" H33.07"  
DER.

| MEASUREMENT. MESURE. MEDIDA.            | REF.                      | M.L. | COM / COL | 1        | 2        | 3        | 4        | 5        | L1       | L2       |
|---|---------------------------|------|-----------|----------|----------|----------|----------|----------|----------|----------|
| 246 x 98 H84   96.85" x 38.58" H33.07"  | SILSI246MTL - SILSD246MTL | 10.5 | 4.938,02  | 5.016,53 | 5.157,02 | 5.276,86 | 5.549,59 | 6.020,66 | 6.128,10 | 6.611,57 |
| 336 x 98 H84   132.28" x 38.58" H33.07" | SILSI336MTL - SILSD336MTL | 13.5 | 6.041,32  | 6.152,89 | 6.338,84 | 6.512,40 | 6.871,90 | 7.528,93 | 7.669,42 | 8.326,45 |

SILENCE. Sofas with 1 arm and terminal box. Canapés avec 1 accoudoir et boîte terminal. Sofás con 1 brazo y mueble contenedor terminal.

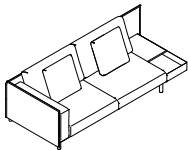

**SILSI246MT**

246 x 98 H84  
96.85" x 38.58" H33.07"  
IZQ.

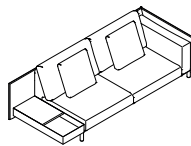

**SILSD246MT**

246 x 98 H84  
96.85" x 38.58" H33.07"  
DER.

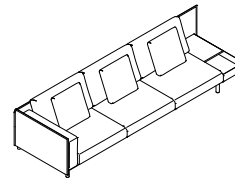

**SILSI336MT**

336 x 98 H84  
132.28" x 38.58" H33.07"  
IZQ.

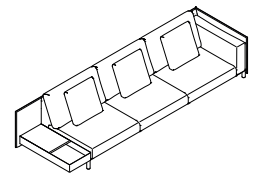

**SILSD336MT**

336 x 98 H84  
132.28" x 38.58" H33.07"  
DER.

| MEASUREMENT. MESURE. MEDIDA.            | REF.                    | M.L. | COM / COL | 1        | 2        | 3        | 4        | 5        | L1       | L2       |
|---|-------------------------|------|-----------|----------|----------|----------|----------|----------|----------|----------|
| 246 x 98 H84   96.85" x 38.58" H33.07"  | SILSI246MT - SILSD246MT | 10.5 | 4.541,32  | 4.619,83 | 4.752,07 | 4.892,56 | 5.157,02 | 5.628,10 | 5.743,80 | 6.214,88 |
| 336 x 98 H84   132.28" x 38.58" H33.07" | SILSI336MT - SILSD336MT | 13.5 | 5.652,89  | 5.760,33 | 5.933,88 | 6.119,83 | 6.206,61 | 7.136,36 | 7.285,12 | 7.925,62 |

SILENCE. Sofas with 1 arm. Canapés avec 1 accoudoir. Sofás con 1 brazo.

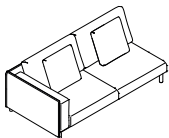

**SILSI203**

203 x 98 H84  
79.92" x 38.58" H33.07"  
IZQ.

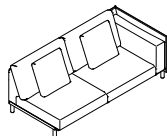

**SILSD203**

203 x 98 H84  
79.92" x 38.58" H33.07"  
DER.

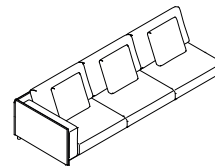

**SILSI293**

293 x 98 H84  
115.35" x 38.58" H33.07"  
IZQ.

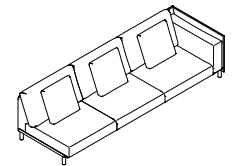

**SILSD293**

293 x 98 H84  
115.35" x 38.58" H33.07"  
DER.

| MEASUREMENT. MESURE. MEDIDA.            | REF.                | M.L. | COM / COL | 1        | 2        | 3        | 4        | 5        | L1       | L2       |
|---|---------------------|------|-----------|----------|----------|----------|----------|----------|----------|----------|
| 203 x 98 H84   79.92" x 38.58" H33.07"  | SILSI203 - SILSD203 | 10   | 3.053,72  | 3.132,23 | 3.264,46 | 3.384,30 | 3.648,76 | 4.119,83 | 4.227,27 | 4.690,08 |
| 293 x 98 H84   115.35" x 38.58" H33.07" | SILSI293 - SILSD293 | 13.5 | 4.111,57  | 4.219,01 | 4.392,56 | 4.586,78 | 4.938,02 | 5.574,38 | 5.723,14 | 6.363,64 |

## SILENCE.

### PRICES. PRIX. PRECIOS.

SILENCE. Sofas with 1 arm and box with integrated LED lamp and USB point. Canapés avec 1 accoudoir et boîte avec lampe LED et prise USB intégrée. Sofás con 1 brazo y mueble contenedor con lámpara LED y toma USB integrada.

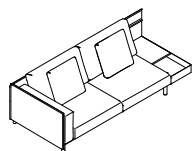

**SILSI243ML**

243 x 98 H84  
95.67" x 38.58" H33.07"  
IZQ.

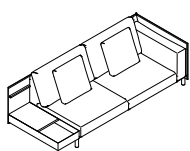

**SILSD243ML**

243 x 98 H84  
95.67" x 38.58" H33.07"  
DER.

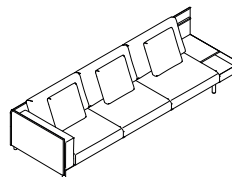

**SILSI333ML**

333 x 98 H84  
131.10" x 38.58" H33.07"  
IZQ.

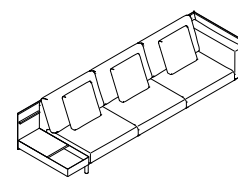

**SILSD333ML**

333 x 98 H84  
131.10" x 38.58" H33.07"  
DER.

| MEASUREMENT. MESURE. MEDIDA.            | REF.                    | M.L. | COM / COL | 1        | 2        | 3        | 4        | 5        | L1       | L2       |
|---|-------------------------|------|-----------|----------|----------|----------|----------|----------|----------|----------|
| 243 x 98 H84   95.67" x 38.58" H33.07"  | SILSI243ML - SILSD243ML | 10.5 | 4.938,02  | 5.016,53 | 5.157,02 | 5.276,86 | 5.549,59 | 6.020,66 | 6.128,10 | 6.611,57 |
| 333 x 98 H84   131.10" x 38.58" H33.07" | SILSI333ML - SILSD333ML | 13.5 | 6.041,32  | 6.152,89 | 6.338,84 | 6.512,40 | 6.871,90 | 7.528,93 | 7.669,42 | 8.326,45 |

SILENCE. Sofas with 1 arm and box. Canapés avec 1 accoudoir et boîte. Sofás con 1 brazo y mueble contenedor.

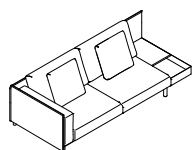

**SILSI243M**

243 x 98 H84  
95.67" x 38.58" H33.07"  
IZQ.

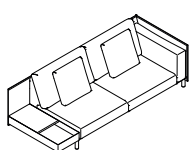

**SILSD243M**

243 x 98 H84  
95.67" x 38.58" H33.07"  
DER.

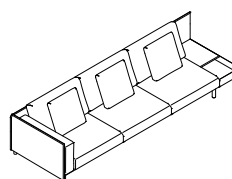

**SILSI333M**

333 x 98 H84  
131.10" x 38.58" H33.07"  
IZQ.

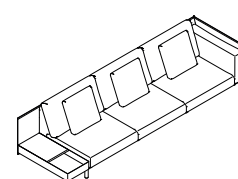

**SILSD333M**

333 x 98 H84  
131.10" x 38.58" H33.07"  
DER.

| MEASUREMENT. MESURE. MEDIDA.            | REF.                  | M.L. | COM / COL | 1        | 2        | 3        | 4        | 5        | L1       | L2       |
|---|-----------------------|------|-----------|----------|----------|----------|----------|----------|----------|----------|
| 243 x 98 H84   95.67" x 38.58" H33.07"  | SILSI243M - SILSD243M | 10.5 | 4.541,32  | 4.619,83 | 4.752,07 | 4.892,56 | 5.157,02 | 5.628,10 | 5.743,80 | 6.214,88 |
| 333 x 98 H84   131.10" x 38.58" H33.07" | SILSI333M - SILSD333M | 13.5 | 5.652,89  | 5.760,33 | 5.933,88 | 6.119,83 | 6.206,61 | 7.136,36 | 7.285,12 | 7.925,62 |

SILENCE. Sofas without arms. Canapés sans accoudoirs. Sofás sin brazos.

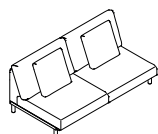

**SILS0180**

180 x 98 H84  
70.87" x 38.58" H33.07"

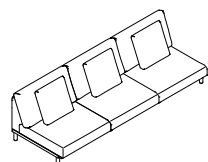

**SILS0270**

270 x 98 H84  
106.30" x 38.58" H33.07"

| MEASUREMENT. MESURE. MEDIDA.            | REF.     | M.L. | COM / COL | 1        | 2        | 3        | 4        | 5        | L1       | L2       |
|---|----------|------|-----------|----------|----------|----------|----------|----------|----------|----------|
| 180 x 98 H84   70.87" x 38.58" H33.07"  | SILS0180 | 8    | 2.876,03  | 2.929,75 | 3.037,19 | 3.140,50 | 3.334,71 | 3.710,74 | 3.772,73 | 4.140,50 |
| 270 x 98 H84   106.30" x 38.58" H33.07" | SILS0270 | 11.5 | 3.797,52  | 3.892,56 | 4.041,32 | 4.190,08 | 4.491,74 | 5.033,06 | 5.144,63 | 5.690,08 |

## SILENCE.

### PRICES. PRIX. PRECIOS.

SILENCE. Sofas without arms and box with integrated LED lamp and USB point. Canapés sans accoudoirs et boîte avec lampe LED et prise USB intégrée. Sofás sin brazo y mueble contenedor con lámpara LED y toma USB integrada.

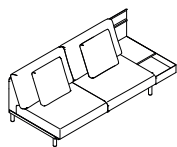

**SILS0D220ML**

220 x 98 H84  
86.61" x 38.58" H33.07"  
DER.

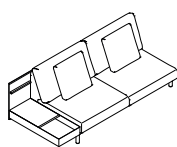

**SILS0I220ML**

220 x 98 H84  
86.61" x 38.58" H33.07"  
IZQ.

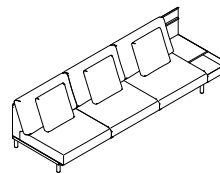

**SILS0D310ML**

310 x 98 H84  
122.05" x 38.58" H33.07"  
DER.

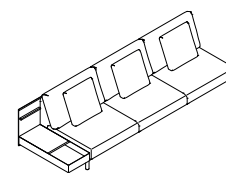

**SILS0I310ML**

310 x 98 H84  
122.05" x 38.58" H33.07"  
IZQ.

| MEASUREMENT. MESURE. MEDIDA.            | REF.                      | M.L. | COM / COL | 1        | 2        | 3        | 4        | 5        | L1       | L2       |
|---|---------------------------|------|-----------|----------|----------|----------|----------|----------|----------|----------|
| 220 x 98 H84   86.61" x 38.58" H33.07"  | SILS0I220ML - SILS0D220ML | 7.5  | 4.322,31  | 4.384,30 | 4.479,34 | 4.578,51 | 4.776,86 | 5.128,10 | 5.198,35 | 5.549,59 |
| 310 x 98 H84   122.05" x 38.58" H33.07" | SILS0I310ML - SILS0D310ML | 13   | 5.673,55  | 5.776,86 | 5.962,81 | 6.144,63 | 6.504,13 | 7.161,16 | 7.301,65 | 7.966,94 |

SILENCE. Sofas without arms and box. Canapés sans accoudoirs et boîte. Sofás sin brazo y mueble contenedor.

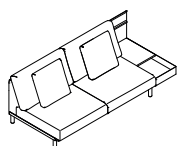

**SILS0D220M**

220 x 98 H84  
86.61" x 38.58" H33.07"  
DER.

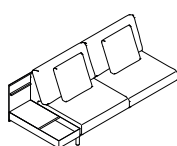

**SILS0I220M**

220 x 98 H84  
86.61" x 38.58" H33.07"  
IZQ.

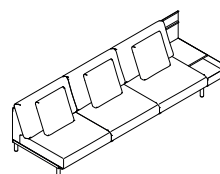

**SILS0D310M**

310 x 98 H84  
122.05" x 38.58" H33.07"  
DER.

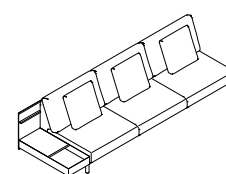

**SILS0I310M**

310 x 98 H84  
122.05" x 38.58" H33.07"  
IZQ.

| MEASUREMENT. MESURE. MEDIDA.            | REF.                    | M.L. | COM / COL | 1        | 2        | 3        | 4        | 5        | L1       | L2       |
|---|-------------------------|------|-----------|----------|----------|----------|----------|----------|----------|----------|
| 220 x 98 H84   86.61" x 38.58" H33.07"  | SILS0I220M - SILS0D220M | 7.5  | 3.929,75  | 3.991,74 | 4.086,78 | 4.190,08 | 4.376,03 | 4.727,27 | 4.814,05 | 5.165,29 |
| 310 x 98 H84   122.05" x 38.58" H33.07" | SILS0I310M - SILS0D310M | 13   | 5.276,86  | 5.392,56 | 5.566,12 | 5.752,07 | 6.111,57 | 6.760,33 | 6.909,09 | 7.553,72 |

SILENCE. Corner. Angle. Rincón.

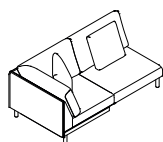

**SILRI188**

188 x 98 H84  
74.02" x 38.58" H33.07"  
IZQ.

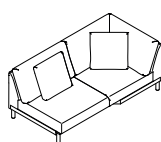

**SILRD188**

188 x 98 H84  
74.02" x 38.58" H33.07"  
DER.

| MEASUREMENT. MESURE. MEDIDA.           | REF.                | M.L. | COM / COL | 1        | 2        | 3        | 4        | 5        | L1       | L2       |
|--|---------------------|------|-----------|----------|----------|----------|----------|----------|----------|----------|
| 188 x 98 H84   74.02" x 38.58" H33.07" | SILRI188 - SILRD188 | 10.5 | 3.194,21  | 3.272,73 | 3.404,96 | 3.545,45 | 3.805,79 | 4.297,52 | 4.392,56 | 4.876,03 |

## SILENCE.

PRICES. PRIX. PRECIOS.

SILENCE. Sofa corner. Canapé angles. Sofá rincón.

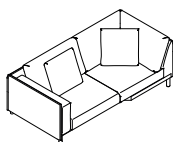

**SILSRI211**

211 x 98 H84  
120.47"x 38.58" H33.07"  
IZQ.

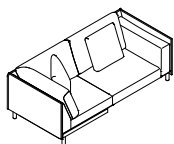

**SILSRD211**

211 x 98 H84  
120.47"x 38.58" H33.07"  
DER.

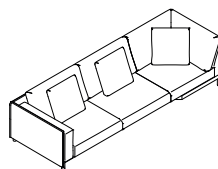

**SILSRI301**

301 x 98 H84  
85.04"x 38.58" H33.07"  
IZQ.

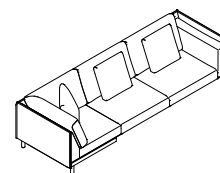

**SILSRD301**

301 x 98 H84  
85.04"x 38.58" H33.07"  
DER.

| MEASUREMENT. MESURE. MEDIDA.            | REF.                  | M.L. | COM / COL | 1        | 2        | 3        | 4        | 5        | L1       | L2       |
|---|-----------------------|------|-----------|----------|----------|----------|----------|----------|----------|----------|
| 211 x 98 H84   83.07" x 38.58" H33.07"  | SILSRI211 - SILSRD211 | 12.5 | 3.735,54  | 3.814,05 | 3.946,28 | 4.086,78 | 4.351,24 | 4.838,84 | 4.938,02 | 5.417,36 |
| 301 x 98 H84   118.50" x 38.58" H33.07" | SILSRI301 - SILSRD301 | 15.5 | 4.710,74  | 4.838,84 | 5.049,59 | 5.260,33 | 5.690,08 | 6.450,41 | 6.619,83 | 7.388,43 |

SILENCE. Corner with terminal box with integrated LED lamp and USB point. Angle avec boîte terminal avec lampe LED et prise USB intégrée. Rincón con mueble contenedor terminal con lámpara LED y toma USB integrada.

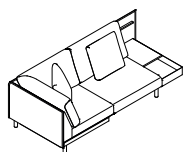

**SILRI231MTL**

231 x 98 H84  
90.94"x 38.58" H33.07"  
IZQ.

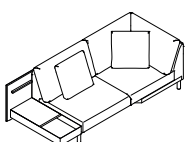

**SILRD231MTL**

231 x 98 H84  
90.94"x 38.58" H33.07"  
DER.

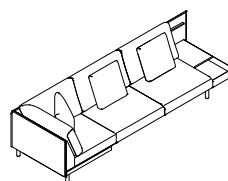

**SILRI321MTL**

321 x 98 H84  
126.38"x 38.58" H33.07"  
IZQ.

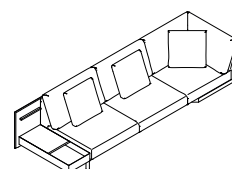

**SILRD321MTL**

321 x 98 H84  
126.38"x 38.58" H33.07"  
DER.

| MEASUREMENT. MESURE. MEDIDA.            | REF.                      | M.L. | COM / COL | 1        | 2        | 3        | 4        | 5        | L1       | L2       |
|---|---------------------------|------|-----------|----------|----------|----------|----------|----------|----------|----------|
| 231 x 98 H84   90.94" x 38.58" H33.07"  | SILRI231MTL - SILRD231MTL | 11.5 | 4.628,10  | 4.706,61 | 4.838,84 | 4.979,34 | 5.243,80 | 5.731,40 | 5.830,58 | 6.309,92 |
| 321 x 98 H84   126.38" x 38.58" H33.07" | SILRI321MTL - SILRD321MTL | 13.5 | 6.090,91  | 6.190,08 | 6.347,11 | 6.504,13 | 6.818,18 | 7.380,17 | 7.504,13 | 8.061,98 |

SILENCE. Corner with terminal box. Angle avec boîte terminal. Rincón con mueble contenedor terminal.

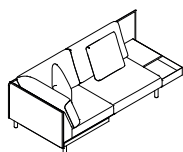

**SILRI231MT**

231 x 98 H84  
90.94"x 38.58" H33.07"  
IZQ.

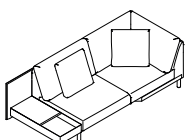

**SILRD231MT**

231 x 98 H84  
90.94"x 38.58" H33.07"  
DER.

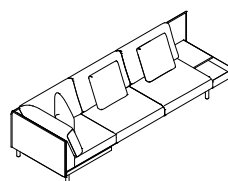

**SILRI321MT**

321 x 98 H84  
126.38"x 38.58" H33.07"  
IZQ.

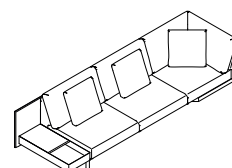

**SILRD321MT**

321 x 98 H84  
126.38"x 38.58" H33.07"  
DER.

| MEASUREMENT. MESURE. MEDIDA.            | REF.                    | M.L. | COM / COL | 1        | 2        | 3        | 4        | 5        | L1       | L2       |
|---|-------------------------|------|-----------|----------|----------|----------|----------|----------|----------|----------|
| 231 x 98 H84   90.94" x 38.58" H33.07"  | SILRI231MT - SILRD231MT | 11.5 | 4.235,54  | 4.314,05 | 4.446,28 | 4.586,78 | 4.847,11 | 5.338,84 | 5.433,88 | 5.917,36 |
| 321 x 98 H84   126.38" x 38.58" H33.07" | SILRI321MT - SILRD321MT | 13.5 | 5.698,35  | 5.793,39 | 5.954,55 | 6.111,57 | 6.425,62 | 6.987,60 | 7.107,44 | 7.669,42 |



## SILENCE.

### PRICES. PRIX. PRECIOS.

SILENCE. Sofa without arms and terminal ottoman. Canapé sans accoudoirs et pouf terminal. Sofá sin brazos con ottoman terminal.

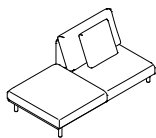

**SILSPI180**

180 x 98 H84  
70.87" x 38.58" H33.07"  
IZQ.

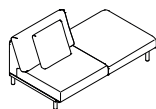

**SILSPD180**

180 x 98 H84  
70.87" x 38.58" H33.07"  
DER.

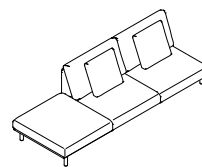

**SILSPI270**

270 x 98 H84  
106.30" x 38.58" H33.07"  
IZQ.

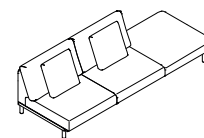

**SILSPD270**

270 x 98 H84  
106.30" x 38.58" H33.07"  
DER.

| MEASUREMENT. MESURE. MEDIDA.            | REF.                  | M.L. | COM / COL | 1        | 2        | 3        | 4        | 5        | L1       | L2       |
|---|-----------------------|------|-----------|----------|----------|----------|----------|----------|----------|----------|
| 180 x 98 H84   70.87" x 38.58" H33.07"  | SILSPI180 - SILSPD180 | 6    | 2.772,73  | 2.818,18 | 2.896,69 | 2.975,21 | 3.140,50 | 3.413,22 | 3.483,47 | 3.764,46 |
| 270 x 98 H84   106.30" x 38.58" H33.07" | SILSPI270 - SILSPD270 | 9    | 3.842,98  | 3.913,22 | 4.033,06 | 4.157,02 | 4.400,83 | 4.847,11 | 4.954,55 | 5.400,83 |

SILENCE. Corner with terminal ottoman. Angle avec pouf terminal. Rincón con ottoman terminal.

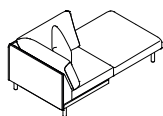

**SILRPI188**

188 x 98 H84  
74.02" x 38.58" H33.07"  
IZQ.

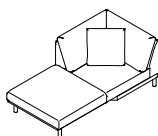

**SILRPD188**

188 x 98 H84  
74.02" x 38.58" H33.07"  
DER.

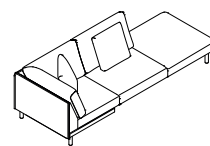

**SILRPI278**

278 x 98 H84  
109.45" x 38.58" H33.07"  
IZQ.

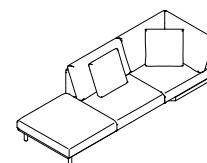

**SILRPD278**

278 x 98 H84  
109.45" x 38.58" H33.07"  
DER.

| MEASUREMENT. MESURE. MEDIDA.            | REF.                  | M.L. | COM / COL | 1        | 2        | 3        | 4        | 5        | L1       | L2       |
|---|-----------------------|------|-----------|----------|----------|----------|----------|----------|----------|----------|
| 188 x 98 H84   74.02" x 38.58" H33.07"  | SILRPI188 - SILRPD188 | 9.5  | 3.462,81  | 3.508,26 | 3.586,78 | 3.665,29 | 3.830,58 | 4.103,31 | 4.173,55 | 4.454,55 |
| 278 x 98 H84   109.45" x 38.58" H33.07" | SILRPI278 - SILRPD278 | 11.5 | 4.272,73  | 4.359,50 | 4.516,53 | 4.681,82 | 4.987,60 | 5.557,85 | 5.673,55 | 6.243,80 |

SILENCE. Ottomans. Poufs. Ottomans.

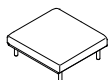

**SILP90**

90 x 98 H40  
35.43" x 38.58" H15.75"

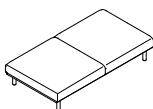

**SILP180**

180 x 98 H40  
70.87" x 38.58" H15.75"

| MEASUREMENT. MESURE. MEDIDA.           | REF.    | M.L. | COM / COL | 1        | 2        | 3        | 4        | 5        | L1       | L2       |
|--|---------|------|-----------|----------|----------|----------|----------|----------|----------|----------|
| 90 x 98 H40   35.43" x 38.58" H15.75"  | SILP90  | 2.5  | 1.710,74  | 1.731,40 | 1.747,93 | 1.772,73 | 1.818,18 | 1.904,96 | 1.942,15 | 2.028,93 |
| 180 x 98 H40   70.87" x 38.58" H15.75" | SILP180 | 5    | 2.413,22  | 2.450,41 | 2.508,26 | 2.578,51 | 2.702,48 | 2.929,75 | 2.983,47 | 3.210,74 |

## SILENCE.

PRICES. PRIX. PRECIOS.

SILENCE. Chaise longue.

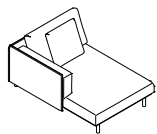

### SILCLI113

113 x 158 H84  
44.49" x 62.20" H33.07"  
IZQ.

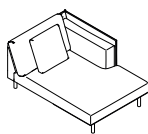

### SILCLD113

113 x 158 H84  
44.49" x 62.20" H33.07"  
DER.

| MEASUREMENT. MESURE. MEDIDA.            | REF.                  | M.L. | COM / COL | 1        | 2        | 3        | 4        | 5        | L1       | L2       |
|---|-----------------------|------|-----------|----------|----------|----------|----------|----------|----------|----------|
| 113 x 158 H84   44.49" x 62.20" H33.07" | SILCLI113 - SILCLD113 | 8    | 2.975,21  | 3.037,19 | 3.148,76 | 3.256,20 | 3.454,55 | 3.842,98 | 3.921,49 | 4.305,79 |

SILENCE. Island with or without arms. Île avec ou sans accoudoirs. Isla con o sin brazos.

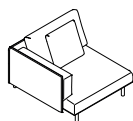

### SILII113

113 x 118 H84  
44.49" x 46.46" H33.07"  
IZQ.

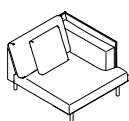

### SILID113

113 x 118 H84  
44.49" x 46.46" H33.07"  
DER.



### SILI090

90 x 118 H84  
35.43" x 46.46" H33.07"

| MEASUREMENT. MESURE. MEDIDA.            | REF.                | M.L. | COM / COL | 1        | 2        | 3        | 4        | 5        | L1       | L2       |
|---|---------------------|------|-----------|----------|----------|----------|----------|----------|----------|----------|
| 113 x 118 H84   44.49" x 46.46" H33.07" | SILII113 - SILID113 | 7    | 2.669,42  | 2.710,74 | 2.805,79 | 2.896,69 | 3.070,25 | 3.384,30 | 3.446,28 | 3.772,73 |
| 90 x 118 H84   35.43" x 46.46" H33.07"  | SILI090             | 5    | 2.107,44  | 2.140,50 | 2.210,74 | 2.264,46 | 2.404,96 | 2.640,50 | 2.694,21 | 2.921,49 |





Designer  
Mario Ruiz

STYLE. ESTILO.  
Singular

## FEATURES. TRAITS. CARACTERÍSTICAS.

Removable upholstery in the seat cushion and back cushions.

Wooden frame covered with cold flexible polyurethane foam and polyester fibre.

The front upholstery of the frame can be chosen in leather or upholstery.

Seat cushion made of different densities of polyurethane foam, padded on the surface with polyester fibre. Back cushions filled with polyester fibre, and washed and sterilised down.

Optional headrests in polyurethane foam upholstered in fabric or metal upholstered in leather.

Two back cushion heights available: Standard (83 cm - 32.68") or Premium (93 cm - 36.61")

**Headrests are mandatory if the Premium back cushion option is chosen.**

Metallic bases covered in manganese-finish polyester powder paint with LDPE stops.

Coussins d'assise et coussins de dossier en tissu déhoussables.

Structure fabriquée en bois et recouverte de mousse de polyuréthane souple à froid et fibre de polyester.

Structure avant recouverte de cuir ou de tissu, au choix.

Coussin d'assise fabriqué à l'aide de diverses densités de mousse de polyuréthane, avec matelassage extérieur en fibre de polyester. Coussins de dossier rembourrés en fibre de polyester et plumes lavées et stérilisées.

Repose-têtes en option fabriqués en mousse de polyuréthane recouvert de tissu ou en métal recouvert de cuir.

Deux hauteurs de coussin proposées pour le dossier : Standard(83 cm) ou Premium (93 cm)

**Les repose-tête sont obligatoires si l'option dossier Premium est choisie.**

Bases métalliques recouvertes de peinture polyester en poudre couleur manganèse, équipées de patins en PEBD.

Tapicería desenfundable en cojín de asiento y cojines de respaldo.

Bastidor de madera recubierto de espuma de poliuretano flexible en frío y fibra de poliéster.

Tapizado frontal del bastidor a escoger en piel o tapicería.

Cojín de asiento realizado en distintas densidades de espuma poliuretano, acolchado en la superficie con fibra. Cojines de respaldo rellenos de fibra de poliéster y pluma lavada y esterilizada.

Reposacabezas opcionales en espuma de poliuretano tapizados en tela o metálicos revestidos en piel.

Dos alturas de respaldo disponibles: Standard (83 cm) o Premium (93 cm)

**Los reposacabezas son obligatorios en caso de escoger la opción de respaldo Premium.**

Bases metálicas recubiertas en pintura poliéster en polvo acabado manganeso con topes de LDPE.

## SLEDD.

### GENERAL MEASUREMENTS. MESURES GÉNÉRALES. MEDIDAS GENERALES.

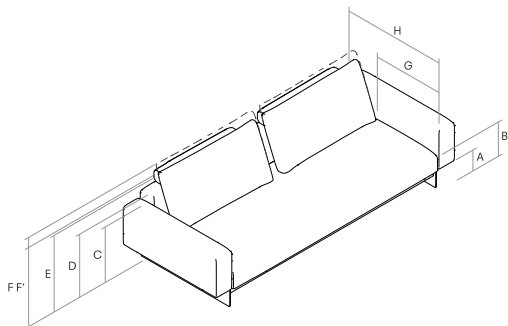

- A.** Base height. Hauteur de base. Altura de base. 9 cm - 3.54"
- B.** Seat height. Hauteur du siège. Altura de asiento. 41 cm - 16.14"
- C.** Arm height. Hauteur DU bras. Altura de brazo. 54 cm - 21.26"
- D.** Backrest height. Hauteur du dossier. Altura del respaldo. 61 cm - 24.02"
- E.** Headrest Height. Hauteur du repose-têtes. Altura del reposacabezas. 73 cm - 28.74"
- F.** Back cushion height. Hauteur du coussin de dossier. Altura del cojín de respaldo. 83 cm - 32.68"
- F'.** Backrest height. Hauteur du dossier. Altura de respaldo. 93 cm - 36.61"
- G.** Seat depth. Profondeur d'assise. Profundidad de asiento. 60 cm - 23.62"
- H.** Depth. Profondeur. Profundidad. 103 cm - 40.55"

### FINISHES. TRAITS. ACABADOS.

Finishes for the metal bases. Finitions des bases métalliques. Acabados de las bases metálicas.

Polyester powder paint. Peinture polyester en poudre. Pintura poliéster en polvo.



Manganese metal.  
Métal manganèse.  
Metal manganeso.

Finishes for the base, tables and accesories. Finitions de la structure de base, des tables et accessoires. Acabados de la base, mesas y accesorios.

Natural stone colours. Couleurs pierre naturelle. Colores piedra natural.



CARRARA



MARQUINA



EMPERADOR

Leather. Cuir. Piel.



NUVOLA  
199



NUVOLA  
163



ELMOBALTIQUE  
88042



NUVOLA  
155



NUVOLA  
151



NUVOLA  
147



ELMOBALTIQUE  
33280



ELMOBALTIQUE  
43003



ELMOBALTIQUE  
99011

## SLEDD.

### CARE & MAINTENANCE. SOIN ET ENTRETIEN. CUIDADO Y MANTENIMIENTO.

---

In order to keep the cushions in good conditions, they have to be tidied up and aired frequently, shaking the material inside, which by doing so will distribute and adapt itself uniformly.

It's recommended whenever possible, to change the position of the seat and back cushions, inverting the most used ones with the other ones less used. Cushions with goose-down padding must be "shaken-up" periodically, gently beating them with your hands and leaving them in the open air in such a way as to evenly settle the padding and to avoid flattening and creases.

Because leathers are fairly delicate, we recommend not setting drinking glasses or objects directly on the table, but instead use the optional marble tray.

Due to the size of the seats, surface wrinkling may occur. This effect is completely normal, and can be removed by gently stroking the seating surface towards the edges of the seat.

Pour assurer un bon entretien, les coussins doivent être manipulés et exposés en plein air fréquemment, pour causée le secouement du matériaux que sous ces action reprends volume et s'assouplissent uniformément.

Ou possible faire alterner la position des coussins d'assise et de dossier en intervenant les plus utilisés avec les mois. Les coussins rembourrés en duvet d'oie doivent être manipulés périodiquement entre les mains et exposés à l'air afin que le rembourrage "reprenne du volume". Vous évitez de la sorte la formation de plis et les coussins ne deviendront pas mous.

Étant donné la délicatesse des cuirs, il est conseillé de ne pas poser de verres ni d'objets directement sur le table mais d'utiliser le plateau en marbre en option.

En raison de la taille des sièges, des plis superficiels peuvent apparaître. Cet effet est tout à fait normal et peut être éliminé en caressant doucement la surface du siège vers les bords du siège.

Para asegurar un correcto mantenimiento, es necesario reacomodar y ventilar los cojines con regularidad sacudiéndolos para que el material interno adquiera aire y se distribuya de modo uniforme.

Cuando es posible, alternar las posiciones de los cojines del asiento y el respaldo, invirtiendo la posición de los que se utilizan más y los que se utilizan menos. Los cojines con relleno de pluma deben ser mullidos periódicamente, golpeándolos suavemente con la mano para recomponer uniformemente el relleno y evitar los aplastamientos y las arrugas.

Dada la delicadeza de la piel, se aconseja no apoyar vasos u otros objetos sobre la mesa, y utilizar la bandeja en mármol en su lugar.

Debido a la dimensión de los asientos, pueden generarse arrugas en la superficie. Este efecto es totalmente normal, y puede desaparecer acariciando suavemente la superficie de asiento, desplazando el tejido hacia los extremos del asiento.

### OPTIONAL FINISHES. FINITIONS EN OPTION. ACABADOS OPCIONALES.

---

SLEDD. Optional headrest. Repose-tête en option. Reposacabezas opcional.

SLEDD. Trim. Structure avant. Embellecedor.

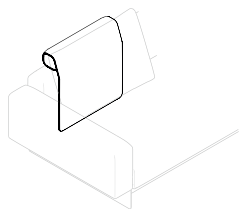

Optional headrest in metal upholstered in leather.

Repose-têtes en option fabriqués en métal recouvert de cuir.

Reposacabezas opcionales en metal tapizados en cuero.

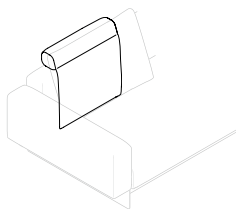

Optional headrest in polyurethane foam upholstered in fabric.

Repose-têtes en option fabriqués en mousse de polyuréthane recouvert de tissu.

Reposacabezas opcionales en espuma de poliuretano tapizados en tela.

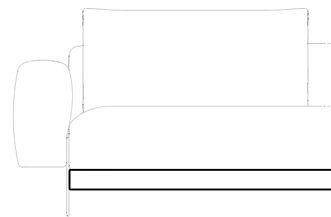

Leather or fabric trim.  
Structure avant en cuir o tissu  
Embellecedor en piel o tejido.

SLEDD.

CONFIGURATOR.

SLEDD. Seat cushions, back cushions and headrests widths. Largeur des coussins d'assise, des coussins de dossier et des repose-têtes.  
Ancho de los cojines de asiento, cojines de respaldo y reposacabezas.

Example. Exemple. Ejemplo.

**SLES280**  
280 x 103 H83  
110.24"x 40.55" H32.68"

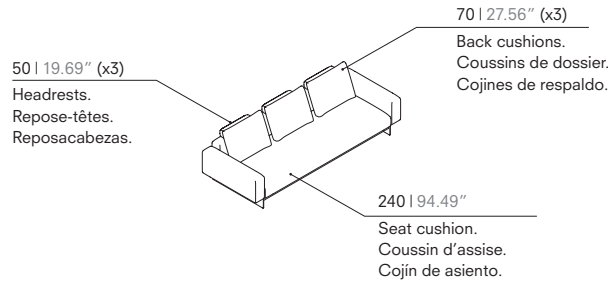

SOFA. CANAPÉ. SOFÁ.

| REF.           | Seat cushion. Coussin d'assise. Cojín de asiento. | Back cushions. Coussins de dossier. Cojines de respaldo. | Headrests. Repose-têtes. Reposacabezas. |
|----------------|---|--|---|
| <b>SLES220</b> | 180   70.87"                                      | 80   31.5" (x2)  | 60   23.62" (x2)                        |
| <b>SLES240</b> | 200   78.74"                                      | 90   35.43" (x2)   | 70   27.56" (x2)                        |
| <b>SLES260</b> | 220   86.61"                                      | 100   39.37" (x2)  | 70   27.56" (x2)                        |
| <b>SLES280</b> | 240   94.49"                                      | 70   27.56" (x3)   | 50   19.69" (x3)                        |
| <b>SLES300</b> | 260   102.36"                                     | 75   29.53" (x3)   | 60   23.62" (x3)                        |
| <b>SLES320</b> | 280   110.24"                                     | 85   33.46" (x3)   | 60   23.62" (x3)                        |
| <b>SLES340</b> | 300   118.11"                                     | 90   35.43" (x3)   | 70   27.56" (x3)                        |

SOFA WITH 1 ARM. CANAPÉ AVEC 1 ACCOUDOIR. SOFÁ CON 1 BRAZO.

| REF.                       | Seat cushion. Coussin d'assise. Cojín de asiento. | Back cushions. Coussins de dossier. Cojines de respaldo. | Headrests. Repose-têtes. Reposacabezas. |
|----------------------------|---|--|---|
| <b>SLESD180   SLESI180</b> | 160   62.99"                                      | 70   27.56" (x2)   | 50   19.69" (x2)                        |
| <b>SLESD200   SLESI200</b> | 180   70.87"                                      | 80   31.5" (x2)  | 60   23.62" (x2)                        |
| <b>SLESD220   SLESI220</b> | 200   78.74"                                      | 90   35.43" (x2)   | 70   27.56" (x2)                        |
| <b>SLESD240   SLESI240</b> | 220   86.61"                                      | 100   39.37" (x2)  | 70   27.56" (x2)                        |
| <b>SLESD260   SLESI260</b> | 240   94.49"                                      | 70   27.56" (x3)   | 50   19.69" (x3)                        |
| <b>SLESD290   SLESI290</b> | 270   106.3"                                      | 80   31.5" (x3)  | 60   23.62" (x3)                        |
| <b>SLESD320   SLESI320</b> | 300   118.11"                                     | 90   35.43" (x3)   | 70   27.56" (x3)                        |

SOFA WITHOUT ARMS. CANAPÉ SANS ACCOUDOIRS. SOFÁ SIN BRAZOS.

| REF.            | Seat cushion. Coussin d'assise. Cojín de asiento. | Back cushions. Coussins de dossier. Cojines de respaldo. | Headrests. Repose-têtes. Reposacabezas. |
|-----------------|---|--|---|
| <b>SLES0160</b> | 160   62.99"                                      | 70   27.56" (x2)   | 50   19.69" (x2)                        |
| <b>SLES0180</b> | 180   70.87"                                      | 80   31.5" (x2)  | 60   23.62" (x2)                        |
| <b>SLES0200</b> | 200   78.74"                                      | 90   35.43" (x2)   | 70   27.56" (x2)                        |
| <b>SLES0220</b> | 220   86.61"                                      | 100   39.37" (x2)  | 70   27.56" (x2)                        |
| <b>SLES0240</b> | 240   94.49"                                      | 70   27.56" (x3)   | 50   19.69" (x3)                        |
| <b>SLES0270</b> | 270   106.3"                                      | 80   31.5" (x3)  | 60   23.62" (x3)                        |
| <b>SLES0300</b> | 300   118.11"                                     | 90   35.43" (x3)   | 70   27.56" (x3)                        |

## SLEDD.

## CONFIGURATOR.

SLEDD. Seat cushions, back cushions and headrests widths. Largeur des coussins d'assise, des coussins de dossier et des repose-têtes.

Ancho de los cojines de asiento, cojines de respaldo y reposacabezas.

| CORNERS. ANGLES. RINCONES.   |   |  |  |
|------------------------------|---|--|--|
| REF.                         | Seat cushion. Coussin d'assise. Cojín de asiento. | Back cushions. Coussins de dossier. Cojines de respaldo. | Headrests. Repose-têtes. Reposacabezas.                |
| <b>SLER103</b>               | 80   31.5"  | 80   31.5" (x1) + 60   23.62" (x1)                       | 50   19.69" (x1) + 60   23.62" (x1)                    |
| <b>SLERDD183   SLERDI183</b> | 160   66.93"                                      | 80   31.5" (x1) + 60   23.62" (x1) + 70   27.56" (x1)    | 50   19.69" (x2) + 60   23.62" (x1)                    |
| <b>SLERDD193   SLERDI193</b> | 170   78.74"                                      | 80   31.5" (x2) + 60   23.62" (x1)                       | 50   19.69" (x1) + 60   23.62" (x2)                    |
| <b>SLERDD203   SLERDI203</b> | 180   70.87"                                      | 80   31.5" (x1) + 60   23.62" (x1) + 90   35.43" (x1)    | 50   19.69" (x1) + 60   23.62" (x1) + 70   27.56" (x1) |
| <b>SLERTD263   SLERTI263</b> | 240   94.49"                                      | 80   31.5" (x1) + 60   23.62" (x1) + 70   27.56" (x2)    | 50   19.69" (x3) + 60   23.62" (x1)                    |
| <b>SLERTD283   SLERTI283</b> | 260   102.36"                                     | 80   31.5" (x3) + 60   23.62" (x1)                       | 50   19.69" (x1) + 60   23.62" (x3)                    |
| <b>SLERTD303   SLERTI303</b> | 280   110.24"                                     | 80   31.5" (x1) + 60   23.62" (x1) + 90   35.43" (x2)    | 50   19.69" (x1) + 60   23.62" (x1) + 70   27.56" (x2) |

| CORNERS WITH 1 ARM. ANGLES AVEC 1 ACCOUDOIR. RINCONES CON 1 BRAZO. |   |  |  |
|--|---|--|--|
| REF.   | Seat cushion. Coussin d'assise. Cojín de asiento. | Back cushions. Coussins de dossier. Cojines de respaldo. | Headrests. Repose-têtes. Reposacabezas.                |
| <b>SLERDBD203   SLERDBI203</b>                                     | 160   66.93"                                      | 80   31.5" (x1) + 60   23.62" (x1) + 70   27.56" (x1)    | 50   19.69" (x2) + 60   23.62" (x1)                    |
| <b>SLERDBD213   SLERDBI213</b>                                     | 170   78.74"                                      | 80   31.5" (x2) + 60   23.62" (x1)                       | 50   19.69" (x1) + 60   23.62" (x2)                    |
| <b>SLERDBD223   SLERDBI223</b>                                     | 180   70.87"                                      | 80   31.5" (x1) + 60   23.62" (x1) + 90   35.43" (x1)    | 50   19.69" (x1) + 60   23.62" (x1) + 70   27.56" (x1) |
| <b>SLERTBD283   SLERTBI283</b>                                     | 240   94.49"                                      | 80   31.5" (x1) + 60   23.62" (x1) + 70   27.56" (x2)    | 50   19.69" (x3) + 60   23.62" (x1)                    |
| <b>SLERTBD303   SLERTBI303</b>                                     | 260   102.36"                                     | 80   31.5" (x3) + 60   23.62" (x1)                       | 50   19.69" (x1) + 60   23.62" (x3)                    |
| <b>SLERTBD323   SLERTBI323</b>                                     | 280   110.24"                                     | 80   31.5" (x1) + 60   23.62" (x1) + 90   35.43" (x2)    | 50   19.69" (x1) + 60   23.62" (x1) + 70   27.56" (x2) |

| TERMINAL MODULE. MODULE TERMINAL. MÓDULO TERMINAL. |   |  |   |
|--|---|--|---|
| REF.   | Seat cushion. Coussin d'assise. Cojín de asiento. | Back cushions. Coussins de dossier. Cojines de respaldo. | Headrests. Repose-têtes. Reposacabezas. |
| <b>SLEMTD220   SLEMTI220</b>                       | 220   86.61"                                      | 70   27.56" (x2)   | 50   19.69" (x2)                        |
| <b>SLEMTD240   SLEMTI240</b>                       | 240   94.49"                                      | 80   31.5" (x2)  | 60   23.62" (x2)                        |
| <b>SLEMTD260   SLEMTI260</b>                       | 260   102.36"                                     | 90   35.43" (x2)   | 70   27.56" (x2)                        |

| CHAISE LONGUE                |   |  |   |
|------------------------------|---|--|---|
| REF.                         | Seat cushion. Coussin d'assise. Cojín de asiento. | Back cushions. Coussins de dossier. Cojines de respaldo. | Headrests. Repose-têtes. Reposacabezas. |
| <b>SLECLD100   SLECLI100</b> | 80   31.5"  | 70   27.56" (x1)   | 50   19.69" (x1)                        |
| <b>SLECLD110   SLECLI110</b> | 90   35.43"                                       | 80   31.5" (x1)  | 60   23.62" (x1)                        |
| <b>SLECLD120   SLECLI120</b> | 100   39.37"                                      | 90   35.43" (x1)   | 70   27.56" (x1)                        |
| <b>SLECLD160   SLECLI160</b> | 160   62.99"                                      | 60   23.62" (x2)   | 50   19.69" (x2)                        |



**SLEDD.**

**PRICES. PRIX. PRECIOS.**

SLEDD. Leather upholstered headrest. Repose-tête recouvert de cuir. Reposacabezas tapizado en piel.



**SLERPSMET50**

50 x 15 H58  
19.69"x 22.83" H5.91"



**SLERPSMET60**

60 x 15 H58  
23.62"x 22.83" H5.91"



**SLERPSMET70**

70 x 15 H58  
27.56"x 22.83" H5.91"

| MEASUREMENT. MESURE. MEDIDA.        | FINISHES. TRAITS. ACABADOS. | REF.        | PRICE. PRIX. PRECIO. |
|-------------------------------------|-----------------------------|-------------|----------------------|
| 50 x 15 H58   19.69"x 22.83" H5.91" | Leather. Cuir. Piel.        | SLERPSMET50 | 582,64               |
| 60 x 15 H58   23.62"x 22.83" H5.91" | Leather. Cuir. Piel.        | SLERPSMET60 | 615,70               |
| 70 x 15 H58   27.56"x 22.83" H5.91" | Leather. Cuir. Piel.        | SLERPSMET70 | 657,02               |

SLEDD. Fabric upholstered headrest. Repose-tête recouvert de tissu. Reposacabezas tapizado en tela.



**SLERPSESP50**

50 x 15 H58  
19.69"x 22.83" H5.91"



**SLERPSESP60**

60 x 15 H58  
23.62"x 22.83" H5.91"



**SLERPSESP70**

70 x 15 H58  
27.56"x 22.83" H5.91"

| MEASUREMENT. MESURE. MEDIDA.        | REF.        | M.L. | COM / COL | 1      | 2      | 3      | 4      | 5      |
|-------------------------------------|-------------|------|-----------|--------|--------|--------|--------|--------|
| 50 x 15 H58   19.69"x 22.83" H5.91" | SLERPSESP50 | 1    | 152,89    | 161,16 | 169,42 | 177,69 | 202,48 | 235,54 |
| 60 x 15 H58   23.62"x 22.83" H5.91" | SLERPSESP60 | 1.1  | 169,42    | 177,69 | 185,95 | 202,48 | 219,01 | 268,60 |
| 70 x 15 H58   27.56"x 22.83" H5.91" | SLERPSESP70 | 1.2  | 177,69    | 194,21 | 202,48 | 219,01 | 243,80 | 293,39 |

SLEDD.

PRICES. PRIX. PRECIOS.

SLEDD. Sofa. Canapé. Sofá.

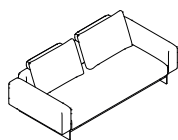

**SLES220**

220 x 103 H83  
86.61"x 40.55" H32.68"

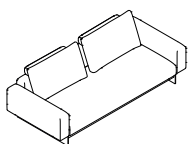

**SLES240**

240 x 103 H83  
94.49"x 40.55" H32.68"

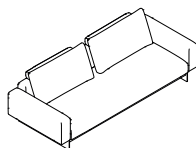

**SLES260**

260 x 103 H83  
102.36"x 40.55" H32.68"

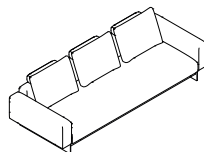

**SLES280**

280 x 103 H83  
110.24"x 40.55" H32.68"

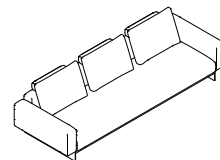

**SLES300**

300 x 103 H83  
118.11"x 40.55" H32.68"

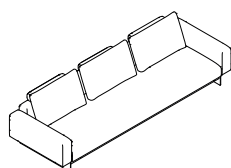

**SLES320**

320 x 103 H83  
125.98"x 40.55" H32.68"

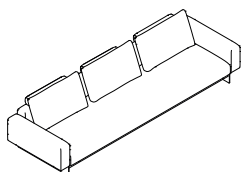

**SLES340**

340 x 103 H83  
133.86"x 40.55" H32.68"

| MEASUREMENT. MESURE. MEDIDA.            | REF.    | M.L. | COM / COL | 1        | 2        | 3        | 4        | 5        | L1       | L2       |
|---|---------|------|-----------|----------|----------|----------|----------|----------|----------|----------|
| 220 x 103 H83   86.61"x 40.55" H32.68"  | SLES220 | 9.1  | 3.400,83  | 3.508,26 | 3.599,17 | 3.731,40 | 3.962,81 | 4.375,21 | 4.541,32 | 5.004,13 |
| 240 x 103 H83   94.49"x 40.55" H32.68"  | SLES240 | 9.8  | 3.615,70  | 3.731,40 | 3.822,31 | 3.962,81 | 4.210,74 | 4.657,02 | 4.830,58 | 5.326,45 |
| 260 x 103 H83   102.36"x 40.55" H32.68" | SLES260 | 10.4 | 3.797,52  | 3.921,49 | 4.020,66 | 4.169,42 | 4.442,15 | 4.913,22 | 5.095,04 | 5.632,23 |
| 280 x 103 H83   110.24"x 40.55" H32.68" | SLES280 | 11   | 4.012,40  | 4.144,63 | 4.252,07 | 4.409,09 | 4.706,61 | 5.450,41 | 5.400,83 | 5.971,07 |
| 300 x 103 H83   118.11"x 40.55" H32.68" | SLES300 | 11.6 | 4.458,68  | 4.607,44 | 4.723,14 | 4.888,43 | 5.202,48 | 5.764,46 | 5.971,07 | 6.590,91 |
| 320 x 103 H83   125.98"x 40.55" H32.68" | SLES320 | 12.3 | 4.632,23  | 4.789,26 | 4.913,22 | 5.095,04 | 5.433,88 | 6.012,40 | 6.243,80 | 6.904,96 |
| 340 x 103 H83   133.86"x 40.55" H32.68" | SLES340 | 12.8 | 4.855,37  | 5.012,40 | 5.144,63 | 5.334,71 | 5.690,08 | 6.301,65 | 6.541,32 | 7.227,27 |

# SLEDD.

PRICES. PRIX. PRECIOS.

SLEDD. Sofa with 1 arm. Canapé avec 1 accoudoir. Sofá con 1 brazo.

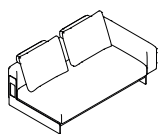

**SLESD180**

180 x 103 H83  
70.87"x 40.55" H32.68"  
DER.

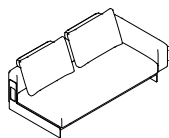

**SLESD200**

200 x 103 H83  
78.74"x 40.55" H32.68"  
DER.

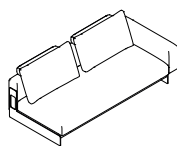

**SLESD220**

220 x 103 H83  
86.61"x 40.55" H32.68"  
DER.

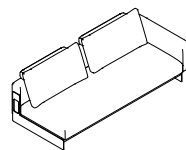

**SLESD240**

240 x 103 H83  
94.49"x 40.55" H32.68"  
DER.

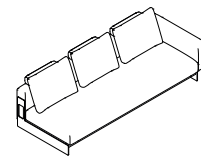

**SLESD260**

260 x 103 H83  
102.36"x 40.55" H32.68"  
DER.

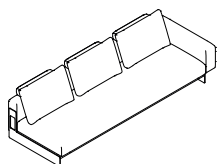

**SLESD290**

290 x 103 H83  
114.17"x 40.55" H32.68"  
DER.

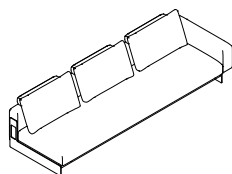

**SLESD320**

320 x 103 H83  
125.98"x 40.55" H32.68"  
DER.

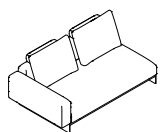

**SLESI180**

180 x 103 H83  
70.87"x 40.55" H32.68"  
IZQ.

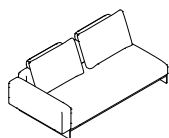

**SLESI200**

200 x 103 H83  
78.74"x 40.55" H32.68"  
IZQ.

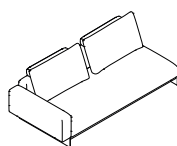

**SLESI220**

220 x 103 H83  
86.61"x 40.55" H32.68"  
IZQ.

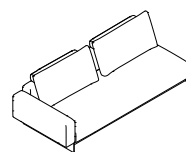

**SLESI240**

240 x 103 H83  
94.49"x 40.55" H32.68"  
IZQ.

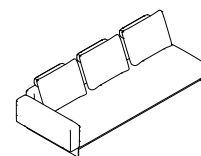

**SLESI260**

260 x 103 H83  
102.36"x 40.55" H32.68"  
IZQ.

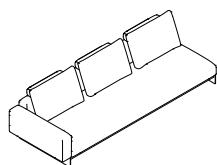

**SLESI290**

290 x 103 H83  
114.17"x 40.55" H32.68"  
IZQ.

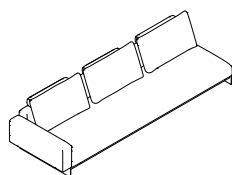

**SLESI320**

320 x 103 H83  
125.98"x 40.55" H32.68"  
IZQ.

| MEASUREMENT. MESURE. MEDIDA.            | REF.                | M.L. | COM / COL | 1        | 2        | 3        | 4        | 5        | L1       | L2       |
|---|---------------------|------|-----------|----------|----------|----------|----------|----------|----------|----------|
| 180 x 103 H83   70.87"x 40.55" H32.68"  | SLESD180 - SLESI180 | 7.6  | 2.871,90  | 2.962,81 | 3.037,19 | 3.136,36 | 3.334,71 | 3.673,55 | 3.797,52 | 4.185,95 |
| 200 x 103 H83   78.74"x 40.55" H32.68"  | SLESD200 - SLESI200 | 8.2  | 3.037,19  | 3.136,36 | 3.210,74 | 3.326,45 | 3.533,06 | 3.904,96 | 4.045,45 | 4.458,68 |
| 220 x 103 H83   86.61"x 40.55" H32.68"  | SLESD220 - SLESI220 | 8.8  | 3.227,27  | 3.334,71 | 3.417,36 | 3.541,32 | 3.772,73 | 4.161,16 | 4.318,18 | 4.764,46 |
| 240 x 103 H83   94.49"x 40.55" H32.68"  | SLESD240 - SLESI240 | 9.4  | 3.466,94  | 3.582,64 | 3.673,55 | 3.814,05 | 4.045,45 | 4.475,21 | 4.640,50 | 5.119,83 |
| 260 x 103 H83   102.36"x 40.55" H32.68" | SLESD260 - SLESI260 | 10.1 | 3.681,82  | 3.797,52 | 3.896,69 | 4.045,45 | 4.309,92 | 4.772,73 | 4.938,02 | 4.971,07 |
| 290 x 103 H83   114.17"x 40.55" H32.68" | SLESD290 - SLESI290 | 11   | 4.144,63  | 4.276,86 | 4.392,56 | 4.557,85 | 4.855,37 | 5.367,77 | 5.574,38 | 6.161,16 |
| 320 x 103 H83   125.98"x 40.55" H32.68" | SLESD320 - SLESI320 | 11.9 | 4.425,62  | 4.574,38 | 4.690,08 | 4.863,64 | 5.185,95 | 5.747,93 | 5.971,07 | 6.607,44 |

## SLEDD.

PRICES. PRIX. PRECIOS.

SLEDD. Sofa without arms. Canapé sans accoudoirs. Sofá sin brazos.

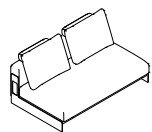

**SLES0160**

160 x 103 H83  
62.99" x 40.55" H32.68"

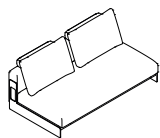

**SLES0180**

180 x 103 H83  
70.87" x 40.55" H32.68"

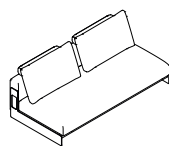

**SLES0200**

200 x 103 H83  
78.74" x 40.55" H32.68"

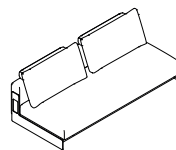

**SLES0220**

220 x 103 H83  
86.61" x 40.55" H32.68"

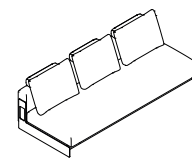

**SLES0240**

240 x 103 H83  
94.49" x 40.55" H32.68"

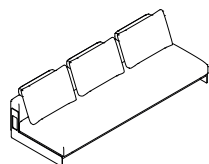

**SLES0270**

270 x 103 H83  
106.30" x 40.55" H32.68"

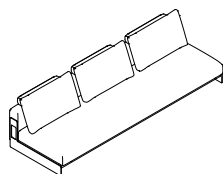

**SLES0300**

300 x 103 H83  
118.11" x 40.55" H32.68"

| MEASUREMENT. MESURE. MEDIDA.             | REF.     | M.L. | COM / COL | 1        | 2        | 3        | 4        | 5        | L1       | L2       |
|--|----------|------|-----------|----------|----------|----------|----------|----------|----------|----------|
| 160 x 103 H83   62.99" x 40.55" H32.68"  | SLES0160 | 7    | 2.475,21  | 2.549,59 | 2.615,70 | 2.706,61 | 2.888,43 | 3.219,01 | 3.318,18 | 3.657,02 |
| 180 x 103 H83   70.87" x 40.55" H32.68"  | SLES0180 | 7.5  | 2.789,26  | 2.888,43 | 2.954,55 | 3.070,25 | 3.260,33 | 3.615,70 | 3.747,93 | 4.144,63 |
| 200 x 103 H83   78.74" x 40.55" H32.68"  | SLES0200 | 8.1  | 2.830,58  | 2.929,75 | 3.012,40 | 3.119,83 | 3.326,45 | 3.698,35 | 3.838,84 | 4.252,07 |
| 220 x 103 H83   86.61" x 40.55" H32.68"  | SLES0220 | 8.7  | 3.061,98  | 3.161,16 | 3.243,80 | 3.367,77 | 3.599,17 | 3.987,60 | 4.144,63 | 4.590,91 |
| 240 x 103 H83   94.49" x 40.55" H32.68"  | SLES0240 | 9.4  | 3.318,18  | 3.425,62 | 3.516,53 | 3.648,76 | 3.896,69 | 4.318,18 | 4.483,47 | 4.971,07 |
| 270 x 103 H83   106.30" x 40.55" H32.68" | SLES0270 | 10   | 3.698,35  | 3.822,31 | 3.921,49 | 4.070,25 | 4.334,71 | 4.805,79 | 4.979,34 | 5.508,26 |
| 300 x 103 H83   118.11" x 40.55" H32.68" | SLES0300 | 11.2 | 4.070,25  | 4.210,74 | 4.318,18 | 4.491,74 | 4.789,26 | 5.326,45 | 5.533,06 | 6.128,10 |

SLEDD. Corner. Angle. Rincón.

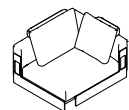

**SLER103**

103 x 103 H83  
40.55" x 40.55" H32.68"  
Single corner.  
Angle uni.  
Rincón simple.

| MEASUREMENT. MESURE. MEDIDA.            | REF.    | M.L. | COM / COL | 1        | 2        | 3        | 4        | 5        | L1       | L2       |
|---|---------|------|-----------|----------|----------|----------|----------|----------|----------|----------|
| 103 x 103 H83   40.55" x 40.55" H32.68" | SLER103 | 6.4  | 2.136,36  | 2.210,74 | 2.268,60 | 2.359,50 | 2.524,79 | 2.805,79 | 2.913,22 | 3.235,54 |

**SLEDD.**

PRICES. PRIX. PRECIOS.

SLEDD. Corner. Angle. Rincón.

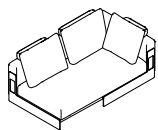

**SLERDD183**

183 x 103 H83  
72.05"x 40.55" H32.68"  
DER.  
Double corner.  
Angle double.  
Rincón doble.

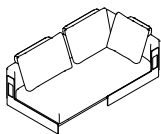

**SLERDD193**

193 x 103 H83  
75.98"x 40.55" H32.68"  
DER.  
Double corner.  
Angle double.  
Rincón doble.

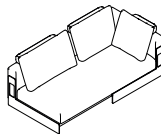

**SLERDD203**

203 x 103 H83  
79.92"x 40.55" H32.68"  
DER.  
Double corner.  
Angle double.  
Rincón doble.

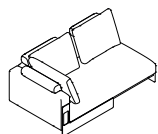

**SLERDI183**

183 x 103 H83  
72.05"x 40.55" H32.68"  
IZQ.  
Double corner.  
Angle double.  
Rincón doble.

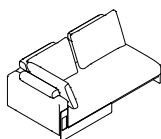

**SLERDI193**

193 x 103 H83  
75.98"x 40.55" H32.68"  
IZQ.  
Double corner.  
Angle double.  
Rincón doble.

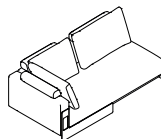

**SLERDI203**

203 x 103 H83  
79.92"x 40.55" H32.68"  
IZQ.  
Double corner.  
Angle double.  
Rincón doble.

| MEASUREMENT. MESURE. MEDIDA.           | REF.                  | M.L. | COM / COL | 1        | 2        | 3        | 4        | 5        | L1       | L2       |
|--|-----------------------|------|-----------|----------|----------|----------|----------|----------|----------|----------|
| 183 x 103 H83   72.05"x 40.55" H32.68" | SLERDD183 - SLERDI183 | 9    | 2.772,73  | 2.880,17 | 2.971,07 | 3.095,04 | 3.326,45 | 3.731,40 | 3.896,69 | 4.359,50 |
| 193 x 103 H83   75.98"x 40.55" H32.68" | SLERDD193 - SLERDI193 | 9.3  | 3.136,36  | 3.252,07 | 3.342,98 | 3.483,47 | 3.714,88 | 4.144,63 | 4.309,92 | 4.780,99 |
| 203 x 103 H83   79.92"x 40.55" H32.68" | SLERDD203 - SLERDI203 | 10   | 3.219,01  | 3.334,71 | 3.425,62 | 3.566,12 | 3.830,58 | 4.276,86 | 4.450,41 | 4.971,07 |

SLEDD.

PRICES. PRIX. PRECIOS.

SLEDD. Corner. Angle. Rincón.

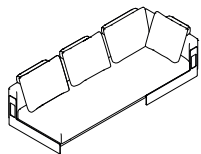

**SLERTD263**

263 x 103 H83  
103.54"x 40.55" H32.68"

DER.  
Triple corner.  
Angle triple.  
Rincón triple.

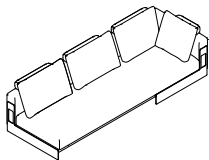

**SLERTD283**

283 x 103 H83  
111.42"x 40.55" H32.68"

DER.  
Triple corner.  
Angle triple.  
Rincón triple.

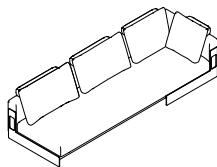

**SLERTD303**

303 x 103 H83  
119.29"x 40.55" H32.68"

DER.  
Triple corner.  
Angle triple.  
Rincón triple.

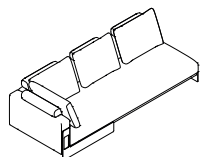

**SLERTI263**

263 x 103 H83  
103.54"x 40.55" H32.68"

IZQ.  
Triple corner.  
Angle triple.  
Rincón triple.

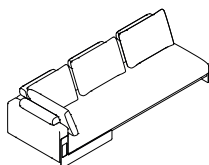

**SLERTI283**

283 x 103 H83  
111.42"x 40.55" H32.68"

IZQ.  
Triple corner.  
Angle triple.  
Rincón triple.

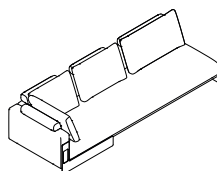

**SLERTI303**

303 x 103 H83  
119.29"x 40.55" H32.68"

IZQ.  
Triple corner.  
Angle triple.  
Rincón triple.

| MEASUREMENT. MESURE. MEDIDA.            | REF.                  | M.L. | COM / COL | 1        | 2        | 3        | 4        | 5        | L1       | L2       |
|---|-----------------------|------|-----------|----------|----------|----------|----------|----------|----------|----------|
| 263 x 103 H83   103.54"x 40.55" H32.68" | SLERTD263 - SLERTI263 | 11.5 | 3.871,90  | 4.004,13 | 4.119,83 | 4.285,12 | 4.590,91 | 5.111,57 | 5.318,18 | 5.913,22 |
| 283 x 103 H83   111.42"x 40.55" H32.68" | SLERTD283 - SLERTI283 | 12.2 | 4.268,60  | 4.417,36 | 4.541,32 | 4.723,14 | 5.053,72 | 5.632,23 | 5.847,11 | 6.500,00 |
| 303 x 103 H83   119.29"x 40.55" H32.68" | SLERTD303 - SLERTI303 | 12.8 | 4.549,59  | 4.706,61 | 4.838,84 | 5.028,93 | 5.376,03 | 5.979,34 | 6.210,74 | 6.896,69 |

## SLEDD.

PRICES. PRIX. PRECIOS.

SLEDD. Corner with 1 arm. Angle avec 1 accoudoir. Rincón con 1 brazo.

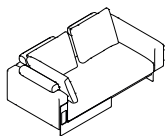

### SLERDBD203

203 x 103 H83

79.92"x 40.55" H32.68"

DER.

Double corner with 1 arm.

Angle double avec 1 accoudoir..

Rincón doble con 1 brazo.

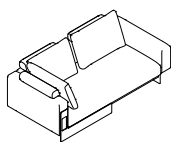

### SLERDBD213

213 x 103 H83

83.86"x 40.55" H32.68"

DER.

Double corner with 1 arm.

Angle double avec 1 accoudoir..

Rincón doble con 1 brazo.

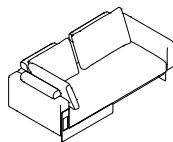

### SLERDBD223

223 x 103 H83

87.80"x 40.55" H32.68"

DER.

Double corner with 1 arm.

Angle double avec 1 accoudoir..

Rincón doble con 1 brazo.

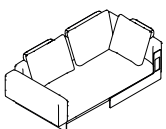

### SLERDBI203

203 x 103 H83

79.92"x 40.55" H32.68"

IZQ.

Double corner with 1 arm.

Angle double avec 1 accoudoir..

Rincón doble con 1 brazo.

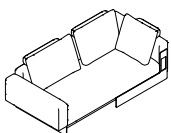

### SLERDBI213

213 x 103 H83

83.86"x 40.55" H32.68"

IZQ.

Double corner with 1 arm.

Angle double avec 1 accoudoir..

Rincón doble con 1 brazo.

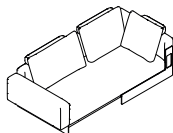

### SLERDBI223

223 x 103 H83

87.80"x 40.55" H32.68"

IZQ.

Double corner with 1 arm.

Angle double avec 1 accoudoir..

Rincón doble con 1 brazo.

| MEASUREMENT. MESURE. MEDIDA.           | REF.                    | M.L. | COM / COL | 1        | 2        | 3        | 4        | 5        | L1       | L2       |
|--|-------------------------|------|-----------|----------|----------|----------|----------|----------|----------|----------|
| 203 x 103 H83   79.92"x 40.55" H32.68" | SLERDBD203 - SLERDBI203 | 10   | 3.491,74  | 3.615,70 | 3.706,61 | 3.855,37 | 4.128,10 | 4.590,91 | 4.772,73 | 5.301,65 |
| 213 x 103 H83   83.86"x 40.55" H32.68" | SLERDBD213 - SLERDBI213 | 10.2 | 3.590,91  | 3.714,88 | 3.822,31 | 3.979,34 | 4.252,07 | 4.731,40 | 4.913,22 | 5.466,94 |
| 223 x 103 H83   87.80"x 40.55" H32.68" | SLERDBD223 - SLERDBI223 | 10.5 | 3.756,20  | 3.880,17 | 3.987,60 | 4.144,63 | 4.442,15 | 4.929,75 | 5.119,83 | 5.681,82 |

**SLEDD.**

PRICES. PRIX. PRECIOS.

SLEDD. Corner with 1 arm. Angle avec 1 accoudoir. Rincón con 1 brazo.

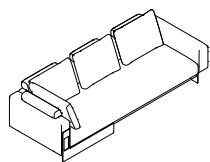

**SLERTBD283**

283 x 103 H83  
111.42"x 40.55" H32.68"

DER.  
Triple corner with 1 arm.  
Angle triple avec 1 accoudoir.  
Rincón triple con 1 brazo.

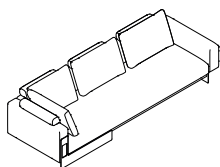

**SLERTBD303**

303 x 103 H83  
119.29"x 40.55" H32.68"

DER.  
Triple corner with 1 arm.  
Angle triple avec 1 accoudoir.  
Rincón triple con 1 brazo.

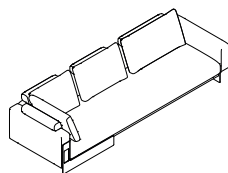

**SLERTBD323**

323 x 103 H83  
127.17"x 40.55" H32.68"

DER.  
Triple corner with 1 arm.  
Angle triple avec 1 accoudoir.  
Rincón triple con 1 brazo.

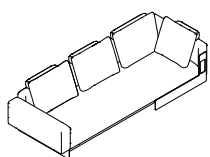

**SLERTBI283**

283 x 103 H83  
111.42"x 40.55" H32.68"

IZQ.  
Triple corner with 1 arm.  
Angle triple avec 1 accoudoir.  
Rincón triple con 1 brazo.

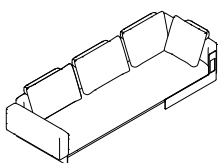

**SLERTBI303**

303 x 103 H83  
119.29"x 40.55" H32.68"

IZQ.  
Triple corner with 1 arm.  
Angle triple avec 1 accoudoir.  
Rincón triple con 1 brazo.

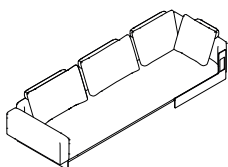

**SLERTBI323**

323 x 103 H83  
127.17"x 40.55" H32.68"

IZQ.  
Triple corner with 1 arm.  
Angle triple avec 1 accoudoir.  
Rincón triple con 1 brazo.

| MEASUREMENT. MESURE. MEDIDA.            | REF.                    | M.L. | COM / COL | 1        | 2        | 3        | 4        | 5        | L1       | L2       |
|---|-------------------------|------|-----------|----------|----------|----------|----------|----------|----------|----------|
| 283 x 103 H83   111.42"x 40.55" H32.68" | SLERTBD283 - SLERTBI283 | 12.5 | 4.417,36  | 4.574,38 | 4.698,35 | 4.888,43 | 5.227,27 | 5.822,31 | 6.045,45 | 6.706,61 |
| 303 x 103 H83   119.29"x 40.55" H32.68" | SLERTBD303 - SLERTBI303 | 13   | 4.681,82  | 4.847,11 | 4.971,07 | 5.169,42 | 5.524,79 | 6.144,63 | 6.384,30 | 7.086,78 |
| 323 x 103 H83   127.17"x 40.55" H32.68" | SLERTBD323 - SLERTBI323 | 13.6 | 4.938,02  | 5.103,31 | 5.243,80 | 5.450,41 | 5.822,31 | 6.466,94 | 6.723,14 | 7.450,41 |



SLEDD. System. Système. Sistema.

PRICES. PRIX. PRECIOS.

SLEDD. Terminal module. Module terminal. Módulo terminal.

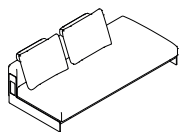

**SLEMTD220**

220 x 103 H83  
86.61"x 40.55" H32.68"  
DER.

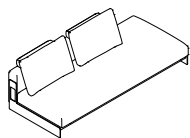

**SLEMTD240**

240 x 103 H83  
94.49"x 40.55" H32.68"  
DER.

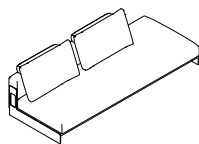

**SLEMTD260**

260 x 103 H83  
102.36"x 40.55" H32.68"  
DER.

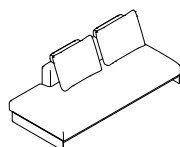

**SLEMTI220**

220 x 103 H83  
86.61"x 40.55" H32.68"  
IZQ.

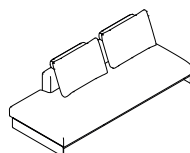

**SLEMTI240**

240 x 103 H83  
94.49"x 40.55" H32.68"  
IZQ.

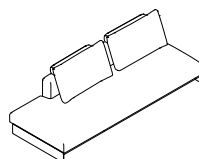

**SLEMTI260**

260 x 103 H83  
102.36"x 40.55" H32.68"  
IZQ.

| MEASUREMENT. MESURE. MEDIDA.            | REF.                  | M.L. | COM / COL | 1        | 2        | 3        | 4        | 5        | L1       | L2       |
|---|-----------------------|------|-----------|----------|----------|----------|----------|----------|----------|----------|
| 220 x 103 H83   86.61"x 40.55" H32.68"  | SLEMTD220 - SLEMTI220 | 8    | 3.260,33  | 3.367,77 | 3.450,41 | 3.566,12 | 3.780,99 | 4.995,87 | 4.309,92 | 4.747,93 |
| 240 x 103 H83   94.49"x 40.55" H32.68"  | SLEMTD240 - SLEMTI240 | 8.7  | 3.549,59  | 3.657,02 | 3.747,93 | 3.880,17 | 4.128,10 | 4.541,32 | 4.706,61 | 5.433,88 |
| 260 x 103 H83   102.36"x 40.55" H32.68" | SLEMTD260 - SLEMTI260 | 9.3  | 3.871,90  | 3.987,60 | 4.086,78 | 4.227,27 | 4.483,47 | 4.938,02 | 5.111,57 | 5.632,23 |

SLEDD.

PRICES. PRIX. PRECIOS.

SLEDD. Chaise longue.

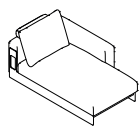

**SLECLD100**

100 x 163 H83  
39.37" x 64.17" H32.68"  
DER.

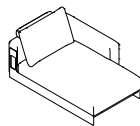

**SLECLD110**

110 x 163 H83  
43.31" x 64.17" H32.68"  
DER.

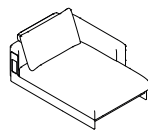

**SLECLD120**

120 x 163 H83  
47.24" x 64.17" H32.68"  
DER.

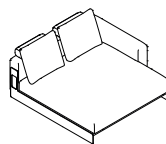

**SLECLD160**

160 x 163 H83  
62.99" x 64.17" H32.68"  
DER.

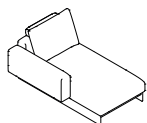

**SLECLI100**

100 x 163 H83  
39.37" x 64.17" H32.68"  
IZQ.

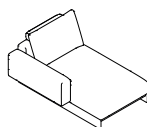

**SLECLI110**

110 x 163 H83  
43.31" x 64.17" H32.68"  
IZQ.

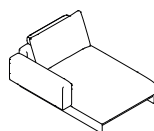

**SLECLI120**

120 x 163 H83  
47.24" x 64.17" H32.68"  
IZQ.

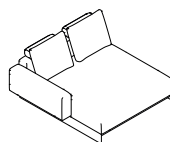

**SLECLI160**

160 x 163 H83  
62.99" x 64.17" H32.68"  
IZQ.

| MEASUREMENT. MESURE. MEDIDA.            | REF.                  | M.L. | COM / COL | 1        | 2        | 3        | 4        | 5        | L1       | L2       |
|---|-----------------------|------|-----------|----------|----------|----------|----------|----------|----------|----------|
| 100 x 163 H83   39.37" x 64.17" H32.68" | SLECLD100 - SLECLI100 | 7.8  | 2.681,82  | 2.780,99 | 2.847,11 | 2.954,55 | 3.152,89 | 3.500,00 | 3.632,23 | 4.020,66 |
| 110 x 163 H83   43.31" x 64.17" H32.68" | SLECLD110 - SLECLI110 | 8.2  | 2.789,26  | 2.888,43 | 2.971,07 | 3.078,51 | 3.285,12 | 3.657,02 | 3.797,52 | 4.210,74 |
| 120 x 163 H83   47.24" x 64.17" H32.68" | SLECLD120 - SLECLI120 | 8.7  | 2.888,43  | 2.995,87 | 3.078,51 | 3.202,48 | 3.425,62 | 3.814,05 | 3.962,81 | 4.409,09 |
| 160 x 163 H83   62.99" x 64.17" H32.68" | SLECLD160 - SLECLI160 | 10.8 | 3.574,38  | 3.714,88 | 3.822,31 | 3.979,34 | 4.268,60 | 4.780,99 | 4.971,07 | 5.549,59 |

SLEDD. System. Système. Sistema.

PRICES. PRIX. PRECIOS.

SLEDD. Modular ottoman. Pouf modulable. Ottoman modular.



**SLEP60**

60 x 103 H41  
23.62"x 40.55" H16.14"

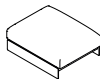

**SLEP80**

80 x 103 H41  
31.50"x 40.55" H16.14"

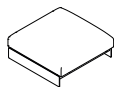

**SLEP103**

103 x 103 H41  
40.55"x 40.55" H16.14"

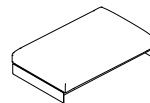

**SLEP160**

160 x 103 H41  
62.99"x 40.55" H16.14"

| MEASUREMENT. MESURE. MEDIDA.           | REF.    | M.L. | COM / COL | 1        | 2        | 3        | 4        | 5        | L1       | L2       |
|--|---------|------|-----------|----------|----------|----------|----------|----------|----------|----------|
| 60 x 103 H41   23.62"x 40.55" H16.14"  | SLEP60  | 2.5  | 1.400,83  | 1.425,62 | 1.450,41 | 1.483,47 | 1.541,32 | 1.640,50 | 1.681,82 | 1.797,52 |
| 80 x 103 H41   31.50"x 40.55" H16.14"  | SLEP80  | 3    | 1.524,79  | 1.549,59 | 1.574,38 | 1.615,70 | 1.681,82 | 1.805,79 | 1.855,37 | 1.995,87 |
| 103 x 103 H41   40.55"x 40.55" H16.14" | SLEP103 | 3.4  | 1.681,82  | 1.723,14 | 1.747,93 | 1.797,52 | 1.880,17 | 2.012,40 | 2.061,98 | 2.227,27 |
| 160 x 103 H41   62.99"x 40.55" H16.14" | SLEP160 | 4.3  | 2.103,31  | 2.152,89 | 2.185,95 | 2.243,80 | 2.351,24 | 2.524,79 | 2.599,17 | 2.805,79 |

SLEDD. Ottomans. Poufs. Ottomans.

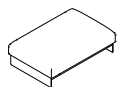

**SLEP120X84**

120 x 84 H41  
47.24"x 33.07" H16.14"

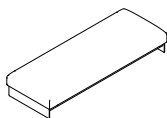

**SLEP220X84**

220 x 84 H41  
86.61"x 33.07" H16.14"

| MEASUREMENT. MESURE. MEDIDA.          | REF.       | M.L. | COM / COL | 1        | 2        | 3        | 4        | 5        | L1       | L2       |
|---------------------------------------|------------|------|-----------|----------|----------|----------|----------|----------|----------|----------|
| 120 x 84 H41   47.24"x 33.07" H16.14" | SLEP120X84 | 3.3  | 1.706,61  | 1.739,67 | 1.772,73 | 1.814,05 | 1.888,43 | 2.020,66 | 2.070,25 | 2.219,01 |
| 220 x 84 H41   86.61"x 33.07" H16.14" | SLEP220X84 | 4.6  | 2.392,56  | 2.442,15 | 2.483,47 | 2.549,59 | 2.665,29 | 2.855,37 | 2.938,02 | 3.152,89 |

## SLEDD.

PRICES. PRIX. PRECIOS.

SLEDD. Tables placed between modules. Tables positionnées entre les modules. Mesas posicionadas entre módulos.



### SLEBAN40

40 x 96 H35  
15.75" x 37.80" H13.78"



### SLEBAN70

70 x 96 H35  
27.56" x 37.80" H13.78"

| MEASUREMENT. MESURE. MEDIDA.          | FINISHES. TRAITS. ACABADOS. | REF.     | PRICE. PRIX. PRECIO. |
|---------------------------------------|-----------------------------|----------|----------------------|
| 40 x 96 H35   15.75" x 37.80" H13.78" | Leather. Cuir. Piel.        | SLEBAN40 | 1.392,56             |
| 70 x 96 H35   27.56" x 37.80" H13.78" | Leather. Cuir. Piel.        | SLEBAN70 | 1.690,08             |

SLEDD. Tables to be placed at the end of modules. Tables à positionner à la fin des modules. Mesas posicionadas al final de los módulos.



### SLEBAND40

40 x 96 H35  
15.75" x 37.80" H13.78"  
DER.



### SLEBANI40

40 x 96 H35  
15.75" x 37.80" H13.78"  
IZQ.



### SLEBAND70

70 x 96 H35  
27.56" x 37.80" H13.78"  
DER.



### SLEBANI70

70 x 96 H35  
27.56" x 37.80" H13.78"  
IZQ.

| MEASUREMENT. MESURE. MEDIDA.          | FINISHES. TRAITS. ACABADOS. | REF.                  | PRICE. PRIX. PRECIO. |
|---------------------------------------|-----------------------------|-----------------------|----------------------|
| 40 x 96 H35   15.75" x 37.80" H13.78" | Leather. Cuir. Piel.        | SLEBAND40 - SLEBANI40 | 1.392,56             |
| 70 x 96 H35   27.56" x 37.80" H13.78" | Leather. Cuir. Piel.        | SLEBAND70 - SLEBANI70 | 1.690,08             |

SLEDD. Marble tray. Plateau en marbre. Bandeja de mármol



### SLEMML

35 x 39 H2  
13.78" x 15.35" H0.79"



### SLEMR

27 x 63 H2  
10.63" x 24.80" H0.79"

| MEASUREMENT. MESURE. MEDIDA.        | FINISHES. TRAITS. ACABADOS.                      | REF.   | PRICE. PRIX. PRECIO. |
|-------------------------------------|--|--------|----------------------|
| 35 x 39 H2   13.78" x 15.35" H0.79" | Natural stone. Pierre naturelle. Piedra Natural. | SLEMML | 367,77               |
| 27 x 63 H2   10.63" x 24.80" H0.79" | Natural stone. Pierre naturelle. Piedra Natural. | SLEMR  | 367,77               |

## SLEDD.

### GENERAL MEASUREMENTS. MESURES GÉNÉRALES. MEDIDAS GENERALES.

---

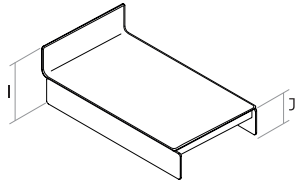

I. Height. Hauteur. Altura. 18 cm - 7.09"

J. Height. Hauteur. Altura. 33 cm - 12.99"

### FINISHES. TRAITS. ACABADOS.

---

Finishes for the metal bases. Finitions des bases métalliques. Acabados de las bases metálicas.

---

Polyester powder paint. Peinture polyester en poudre. Pintura poliéster en polvo.

---



Manganese metal.  
Métal manganèse.  
Metal manganeso.

Finishes for the base, tables and accessories. Finitions de la structure de base, des tables et accessoires. Acabados de la base, mesas y accesorios.

---

Natural stone colours. Couleurs pierre naturelle. Colores piedra natural.

---



CARRARA



MARQUINA



EMPERADOR

Leather. Cuir. Piel.

---



NUVOLA  
199



NUVOLA  
163



ELMOBALTIQUE  
88042



NUVOLA  
155



NUVOLA  
151



NUVOLA  
147



ELMOBALTIQUE  
33280



ELMOBALTIQUE  
43003



ELMOBALTIQUE  
99011

# TIME.

# SOFA. CANAPÉ. SOFÁ.



Designer  
Mario Ruiz

STYLE. ESTILO.  
Cozy

## FEATURES. TRAITS. CARACTERÍSTICAS.

---

Seat, back and auxiliary cushions with removable covers.

Wooden frame covered with flexible cold shaped polyurethane foam and polyester fibre.

Suspension consisting of elasticated webbing in different tensions.

Seat cushions in polyurethane foam inserts, padded with fibre and washed, sterilised down. Back cushions made with polyester foam inserts and washed, sterilised down. Arm cushions with polyurethane foam inserts, padded with fibre and washed, sterilised down. Auxiliary cushions made from fibre and washed, sterilised down.

Arm and base structures in solid oak.

Coussins de l'assise, du dossier et auxiliaires déhoussables.

Cadre en bois recouvert de mousse de polyuréthane souple à froid et de fibre de polyester.

Suspension au moyen de sangles élastiques entrelacées de différentes tensions.

Coussins de l'assise garnis de mousse polyuréthane, matelassés avec de la fibre et des plumes lavées et stérilisées. Coussins du dossier garnis de mousse polyuréthane, matelassés avec de la fibre et des plumes lavées et stérilisées. Coussins des accoudoirs garnis de mousse polyuréthane, matelassés avec de la fibre et des plumes lavées et stérilisées. Coussins auxiliaires en fibre et plumes lavées et stérilisées.

Structure des accoudoirs et pieds en chêne massif.

Cojines de asiento, respaldos y auxiliares desenfundables.

Bastidor de madera recubierto de espuma de poliuretano flexible en frío y fibra de poliéster.

Suspensión mediante cinchas elásticas entrelazadas de diferentes tensiones.

Cojines de asiento realizados con inserto de espuma de poliuretano, acolchado con fibra y pluma lavada y esterilizada. Cojines de respaldo con inserto de espuma de poliuretano, acolchado con fibra y pluma lavada y esterilizada. Cojines de brazo con inserto de espuma de poliuretano, acolchado con fibra y pluma lavada y esterilizada. Cojines auxiliares realizados en fibra y pluma lavada y esterilizada.

Estructura de brazo y patas en roble macizo.

TIME.

GENERAL MEASUREMENTS. MESURES GÉNÉRALES. MEDIDAS GENERALES.

---

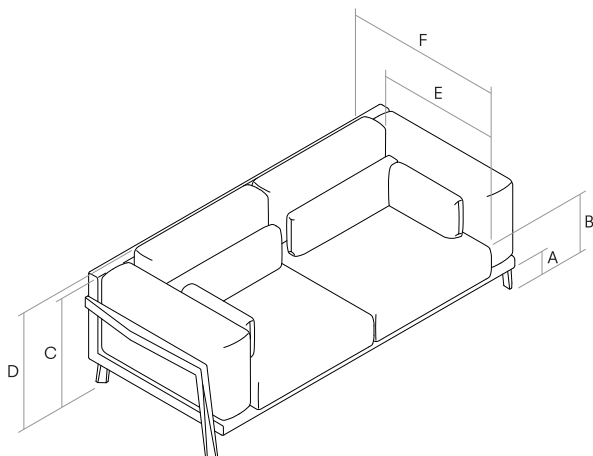

- A. Base height. Hauteur de base. Altura de base. 15 cm - 5.91"
- B. Seat height. Hauteur du siège. Altura de asiento. 42 cm - 16.54"
- C. Arm height. Hauteur du bras. Altura de brazo. 68 cm - 26.77"
- D. Backrest height. Hauteur du dossier. Altura de respaldo. 84 cm - 33.07"
- E. Seat depth. Profondeur d'assise. Profundidad de sentada. 68 cm - 26.77"
- F. Depth. Profondeur. Profundidad. 98 cm - 38.58"

FINISHES. TRAITS. ACABADOS.

---

Finishes for the arm and the legs. Finitions pour le bras et les pieds. Acabados del brazo y las patas.

---

Wood finishes. Finitions bois. Acabado de la madera.

---



**RN**  
Natural oak.  
Chêne naturel.  
Roble natural.

TIME.

PRICES. PRIX. PRECIOS.

TIME. Sofa. Canapé. Sofá.

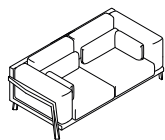

**TIMS200**

200 x 98 H84  
78.74" x 38.58" H33.07"

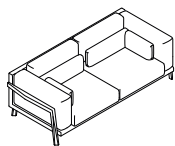

**TIMS220**

220 x 98 H84  
86.61" x 38.58" H33.07"

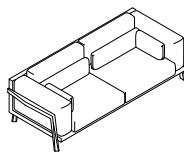

**TIMS240**

240 x 98 H84  
94.49" x 38.58" H33.07"

| MEASUREMENT. MESURE. MEDIDA.           | REF.    | M.L. | COM / COL | 1        | 2        | 3        | 4        | 5        | L1       | L2       |
|--|---------|------|-----------|----------|----------|----------|----------|----------|----------|----------|
| 200 x 98 H84   78.74" x 38.58" H33.07" | TIMS200 | 11.5 | 2.946,28  | 3.061,98 | 3.210,74 | 3.376,03 | 3.710,74 | 4.322,31 | 4.454,55 | 5.008,26 |
| 220 x 98 H84   86.61" x 38.58" H33.07" | TIMS220 | 12   | 3.086,78  | 3.210,74 | 3.392,56 | 3.545,45 | 3.884,30 | 4.549,59 | 4.673,55 | 5.268,60 |
| 240 x 98 H84   94.49" x 38.58" H33.07" | TIMS240 | 13   | 3.297,52  | 3.446,28 | 3.640,50 | 3.842,98 | 4.210,74 | 4.971,07 | 5.136,36 | 5.805,79 |

TIME. Additional back. Supplément dossier. Suplemento respaldo.



**TIMSR**

20 x 10  
7.87" x 3.94"

Foam supplement for higher backrest. Price per unit and for all measures.  
Supplément en mousse pour obtenir un dossier plus haut. Prix par unité et pour toutes les mesures.  
Suplemento de espuma para conseguir un respaldo más alto. Precio por unidad y para todas las medidas.

| MEASUREMENT. MESURE. MEDIDA. | FINISHES. TRAITS. ACABADOS.   | REF.  | PRICE. PRIX. PRECIO. |
|------------------------------|---|-------|----------------------|
| 20 x 10   7.87" x 3.94"      | Foam upholstered in corporate fabric. Mousse recouverte de tissu d'entreprise. Espuma tapizada en tejido corporativo. | TIMSR | 60,70                |



TIME.

PRICES. PRIX. PRECIOS.

TIME. Sofas with 1 arm. Canapés avec 1 accoudoir. Sofás con 1 brazo.

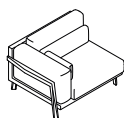

**TIMSI120**

120 x 98 H84  
47.24" x 38.58" H33.07"  
IZQ.

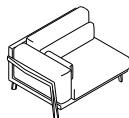

**TIMSI130**

130 x 98 H84  
51.18" x 38.58" H33.07"  
IZQ.

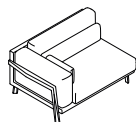

**TIMSI140**

140 x 98 H84  
55.12" x 38.58" H33.07"  
IZQ.

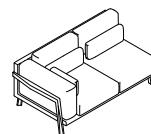

**TIMSI175**

175 x 98 H84  
68.90" x 38.58" H33.07"  
IZQ.

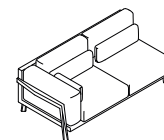

**TIMSI195**

195 x 98 H84  
76.77" x 38.58" H33.07"  
IZQ.

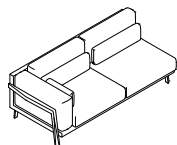

**TIMSI215**

215 x 98 H84  
84.65" x 38.58" H33.07"  
IZQ.

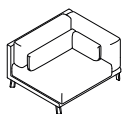

**TIMSD120**

120 x 98 H84  
47.24" x 38.58" H33.07"  
DER.

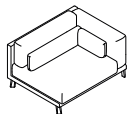

**TIMSD130**

130 x 98 H84  
51.18" x 38.58" H33.07"  
DER.

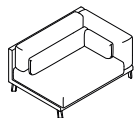

**TIMSD140**

140 x 98 H84  
55.12" x 38.58" H33.07"  
DER.

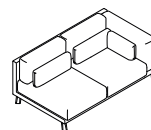

**TIMSD175**

175 x 98 H84  
68.90" x 38.58" H33.07"  
DER.

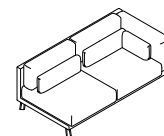

**TIMSD195**

195 x 98 H84  
76.77" x 38.58" H33.07"  
DER.

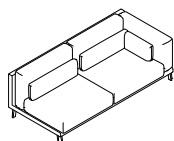

**TIMSD215**

215 x 98 H84  
84.65" x 38.58" H33.07"  
DER.

| MEASUREMENT. MESURE. MEDIDA.           | REF.                | M.L. | COM / COL | 1        | 2        | 3        | 4        | 5        | L1       | L2       |
|--|---------------------|------|-----------|----------|----------|----------|----------|----------|----------|----------|
| 120 x 98 H84   47.24" x 38.58" H33.07" | TIMSI120 - TIMSD120 | 6.5  | 1.929,75  | 2.000,00 | 2.090,91 | 2.210,74 | 2.404,96 | 2.818,18 | 2.904,96 | 3.272,73 |
| 130 x 98 H84   51.18" x 38.58" H33.07" | TIMSI130 - TIMSD130 | 7    | 2.000,00  | 2.090,91 | 2.185,95 | 2.297,52 | 2.500,00 | 2.946,28 | 3.024,79 | 3.404,96 |
| 140 x 98 H84   55.12" x 38.58" H33.07" | TIMSI140 - TIMSD140 | 7.5  | 2.090,91  | 2.177,69 | 2.297,52 | 2.404,96 | 2.623,97 | 3.078,51 | 3.165,29 | 3.570,25 |
| 175 x 98 H84   68.90" x 38.58" H33.07" | TIMSI175 - TIMSD175 | 10.5 | 2.599,17  | 2.710,74 | 2.876,03 | 3.008,26 | 3.305,79 | 3.900,83 | 4.016,53 | 4.549,59 |
| 195 x 98 H84   76.77" x 38.58" H33.07" | TIMSI195 - TIMSD195 | 10.5 | 2.747,93  | 2.876,03 | 3.024,79 | 3.177,69 | 3.500,00 | 4.119,83 | 4.260,33 | 4.830,58 |
| 215 x 98 H84   84.65" x 38.58" H33.07" | TIMSI215 - TIMSD215 | 11   | 2.921,49  | 3.061,98 | 3.210,74 | 3.376,03 | 3.710,74 | 4.359,50 | 4.487,60 | 5.095,04 |

TIME.

PRICES. PRIX. PRECIOS.

TIME. Corner. Angle. Rincón.

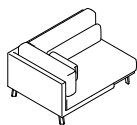

**TIMRI140**

140 x 98 H84  
55.12"x 38.58" H33.07"  
IZQ.

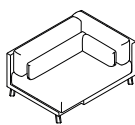

**TIMRD140**

140 x 98 H84  
55.12"x 38.58" H33.07"  
DER.

| MEASUREMENT. MESURE. MEDIDA.          | REF.                | M.L. | COM / COL | 1        | 2        | 3        | 4        | 5        | L1       | L2       |
|---------------------------------------|---------------------|------|-----------|----------|----------|----------|----------|----------|----------|----------|
| 140 x 98 H84   55.12"x 38.58" H33.07" | TIMRI140 - TIMRD140 | 8.5  | 2.123,97  | 2.219,01 | 2.351,24 | 2.483,47 | 2.739,67 | 3.264,46 | 3.334,71 | 3.797,52 |

TIME. Peninsula. Péninsule. Península.



**TIMPEI170**

170 x 125 H84  
66.93"x 49.21" H33.07"  
IZQ.

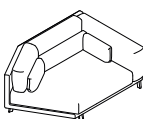

**TIMPED170**

170 x 125 H84  
66.93"x 49.21" H33.07"  
DER.

| MEASUREMENT. MESURE. MEDIDA.           | REF.                  | M.L. | COM / COL | 1        | 2        | 3        | 4        | 5        | L1       | L2       |
|--|-----------------------|------|-----------|----------|----------|----------|----------|----------|----------|----------|
| 170 x 125 H84   66.93"x 49.21" H33.07" | TIMPEI170 - TIMPED170 | 11   | 2.805,79  | 2.946,28 | 3.115,70 | 3.272,73 | 3.603,31 | 4.260,33 | 4.376,03 | 4.971,07 |

TIME. Chaise longue.

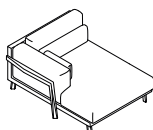

**TIMCLI120**

120 x 160 H84  
47.24"x 62.99" H33.07"  
IZQ.

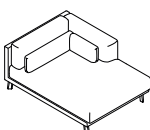

**TIMCLD120**

120 x 160 H84  
47.24"x 62.99" H33.07"  
DER.

| MEASUREMENT. MESURE. MEDIDA.           | REF.                  | M.L. | COM / COL | 1        | 2        | 3        | 4        | 5        | L1       | L2       |
|--|-----------------------|------|-----------|----------|----------|----------|----------|----------|----------|----------|
| 120 x 160 H84   47.24"x 62.99" H33.07" | TIMCLI120 - TIMCLD120 | 9    | 2.272,73  | 2.404,96 | 2.500,00 | 2.669,42 | 2.921,49 | 3.491,74 | 3.603,31 | 4.095,04 |

TIME.

PRICES. PRIX. PRECIOS.

---

TIME. Ottoman. Pouf. Ottoman.

---

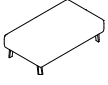

**TIMP120**

120 x 70 H42

47.24" x 27.56" H16.54"

| MEASUREMENT. MESURE. MEDIDA.           | REF.    | M.L. | COM / COL | 1      | 2        | 3        | 4        | 5        | L1       | L2       |
|--|---------|------|-----------|--------|----------|----------|----------|----------|----------|----------|
| 120 x 70 H42   47.24" x 27.56" H16.54" | TIMP120 | 3.5  | 942,15    | 966,94 | 1.012,40 | 1.037,19 | 1.152,89 | 1.309,92 | 1.342,98 | 1.491,74 |

# VENICE.

# SOFA. CANAPÉ. SOFÁ.



Designer  
Mario Ruiz

STYLE. ESTILO.  
New Classic

VERSION. VERSIÓN.  
Visible base version. Version base visible. Versión base visible.

## FEATURES. TRAITS. CARACTERÍSTICAS.

---

Completely removable upholstery. In leather, seat and back cushions with removable covers.

Wooden frame covered with flexible cold shaped polyurethane foam and polyester fibre.

Suspension consisting of elasticated webbing in different tensions.

Seat cushion made with polyurethane foam inserts, padded with fibre and washed, sterilised down. Back cushions stuffed with polyester fibre and washed, sterilised down.

Metal bases coated with polyester powder paint and a manganese topcoat with LDPE stops or solid oak bases.

Tapiserie entièrement déhoussable. En cuir, coussin de l'assise et coussins du dossier déhoussables.

Cadre en bois recouvert de mousse de polyuréthane souple à froid et de fibre de polyester.

Suspension au moyen de sangles élastiques entrelacées de différentes tensions.

Coussin de l'assise garnis de mousse polyuréthane, matelassé avec de la fibre et des plumes lavées et stérilisées. Coussins du dossier garnis de fibre de polyester et plumes lavées et stérilisées.

Bases métalliques recouverts en peinture polyester en poudre finition manganèse avec butées en PEBD ou bases en chêne massif.

Tapicería totalmente desenfundable. En piel, cojín de asiento y respaldos desenfundables.

Bastidor de madera recubierto de espuma de poliuretano flexible en frío y fibra de poliéster.

Suspensión mediante cinchas elásticas entrelazadas de diferentes tensiones.

Cojín de asiento realizado con inserto de espuma de poliuretano, acolchado con fibra y pluma lavada y esterilizada. Cojines de respaldo rellenos de fibra de poliéster y pluma lavada y esterilizada.

Bases metálicas recubiertas en pintura poliéster en polvo acabado manganeso con topes de LDPE o bases en roble macizo.

## VENICE.

### GENERAL MEASUREMENTS. MESURES GÉNÉRALES. MEDIDAS GENERALES.

---

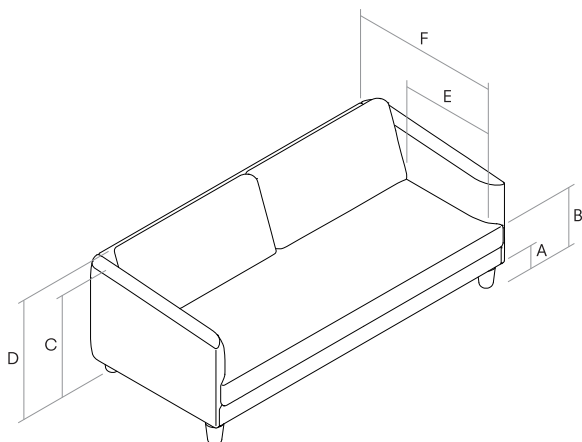

- A. Base height. Hauteur de la base. Altura de la pata. 15 cm - 5.91"
- B. Seat height. Hauteur du siège. Altura de asiento. 44 cm - 17.32"
- C. Arm height. Hauteur du bras. Altura de brazo. 62 cm - 24.41"
- D. Backrest height. Hauteur du dossier. Altura de respaldo. 80 cm - 31.50"
- E. Seat depth. Profondeur d'assise. Profundidad de sentada. 62 cm - 24.41"
- F. Depth. Profondeur. Profundidad. 94 cm - 37.01"

### FINISHES. TRAITS. ACABADOS.

---

Finishes for the metal bases. Finitions des pieds métalliques. Acabados de las patas metálicas.

---

Polyester powder paint. Peinture polyester en poudre. Pintura poliéster en polvo.

---



Manganese metal.  
Métal manganèse.  
Metal manganeso.

Finishes for the wooden feet. Finitions des pieds en bois. Acabados de los pies en madera.

---

Wood finishes. Finitions bois. Acabado de la madera.

---



Natural oak.  
Chêne naturel.  
Roble natural.



**RT**  
Dark stained oak.  
Chêne teint foncée.  
Roble teñido oscuro.



**RL**  
Oak painted in black with open-pore finish.  
Chêne laqué noir à pores ouverts.  
Roble lacado negro por abierto.

### OPTIONAL BASES. PIEDS EN OPTION. PATAS OPCIONALES.

---

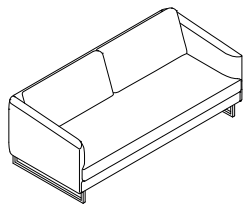

Metal bases. Pieds métalliques. Patas metálicas.

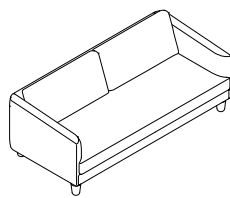

Solid oak feet. Pieds en chêne massif.  
Pies en roble macizo.

## VENICE.

PRICES. PRIX. PRECIOS.

VENICE. Sofas. Canapés. Sofás.

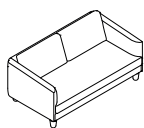

**VENS168**

168 x 94 H80  
66.14" x 37.01" H31.50"

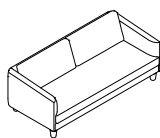

**VENS200**

200 x 94 H80  
78.74" x 37.01" H31.50"

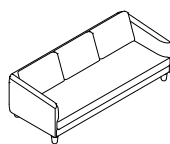

**VENS218**

218 x 94 H80  
85.83" x 37.01" H31.50"

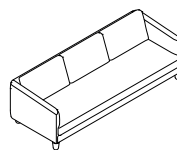

**VENS242**

242 x 94 H80  
95.28" x 37.01" H31.50"

| MEASUREMENT. MESURE. MEDIDA.           | REF.    | M.L. | COM / COL | 1        | 2        | 3        | 4        | 5        | L1       | L2       |
|--|---------|------|-----------|----------|----------|----------|----------|----------|----------|----------|
| 168 x 94 H80   66.14" x 37.01" H31.50" | VENS168 | 8    | 2.359,50  | 2.475,21 | 2.570,25 | 2.710,74 | 2.946,28 | 3.454,55 | 3.545,45 | 3.971,07 |
| 200 x 94 H80   78.74" x 37.01" H31.50" | VENS200 | 9    | 2.553,72  | 2.657,02 | 2.772,73 | 2.888,43 | 3.148,76 | 3.632,23 | 3.735,54 | 4.165,29 |
| 218 x 94 H80   85.83" x 37.01" H31.50" | VENS218 | 9    | 2.710,74  | 2.789,26 | 2.929,75 | 3.061,98 | 3.305,79 | 3.789,26 | 3.884,30 | 4.330,58 |
| 242 x 94 H80   95.28" x 37.01" H31.50" | VENS242 | 10.5 | 2.904,96  | 3.045,45 | 3.194,21 | 3.326,45 | 3.632,23 | 4.235,54 | 4.359,50 | 4.917,36 |

VENICE. Sofas with 1 arm. Canapés avec 1 accoudoir. Sofás con 1 brazo.

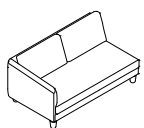

**VENS1158**

158 x 94 H80  
62.20" x 37.01" H31.50"  
IZQ.

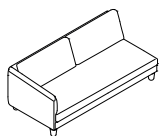

**VENS1190**

190 x 94 H80  
74.80" x 37.01" H31.50"  
IZQ.

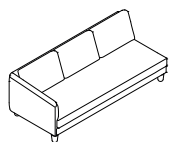

**VENS1208**

208 x 94 H80  
81.89" x 37.01" H31.50"  
IZQ.

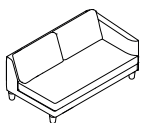

**VENS1158**

158 x 94 H80  
62.20" x 37.01" H31.50"  
DER.

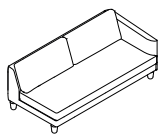

**VENS1190**

190 x 94 H80  
74.80" x 37.01" H31.50"  
DER.

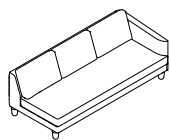

**VENS1208**

208 x 94 H80  
81.89" x 37.01" H31.50"  
DER.

| MEASUREMENT. MESURE. MEDIDA.           | REF.                | M.L. | COM / COL | 1        | 2        | 3        | 4        | 5        | L1       | L2       |
|--|---------------------|------|-----------|----------|----------|----------|----------|----------|----------|----------|
| 158 x 94 H80   62.20" x 37.01" H31.50" | VENS1158 - VENS1158 | 8    | 2.140,50  | 2.239,67 | 2.342,98 | 2.450,41 | 2.657,02 | 3.086,78 | 3.177,69 | 3.570,25 |
| 190 x 94 H80   74.80" x 37.01" H31.50" | VENS1190 - VENS1190 | 8    | 2.342,98  | 2.421,49 | 2.528,93 | 2.640,50 | 2.851,24 | 3.272,73 | 3.367,77 | 3.735,54 |
| 208 x 94 H80   81.89" x 37.01" H31.50" | VENS1208 - VENS1208 | 9    | 2.475,21  | 2.553,72 | 2.657,02 | 2.789,26 | 3.008,26 | 3.475,21 | 3.545,45 | 3.971,07 |

## VENICE.

### PRICES. PRIX. PRECIOS.

#### VENICE. Corner. Angle. Rincón.

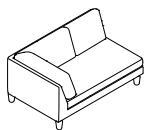

#### VENRI168

168 x 94 H80  
66.14"x 37.01" H31.50"  
IZQ.

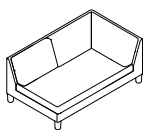

#### VENRD168

168 x 94 H80  
66.14"x 37.01" H31.50"  
DER.

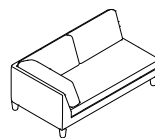

#### VENRI184

168 x 94 H80  
72.44"x 37.01" H31.50"  
IZQ.

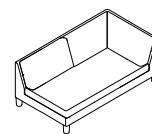

#### VENRD184

168 x 94 H80  
72.44"x 37.01" H31.50"  
DER.

| MEASUREMENT. MESURE. MEDIDA.          | REF.                | M.L. | COM / COL | 1        | 2        | 3        | 4        | 5        | L1       | L2       |
|---------------------------------------|---------------------|------|-----------|----------|----------|----------|----------|----------|----------|----------|
| 168 x 94 H80   66.14"x 37.01" H31.50" | VENRI168 - VENRD168 | 8.5  | 2.247,93  | 2.359,50 | 2.475,21 | 2.615,70 | 2.888,43 | 3.404,96 | 3.508,26 | 3.954,55 |
| 184 x 94 H80   72.44"x 37.01" H31.50" | VENRI184 - VENRD184 | 9    | 2.421,49  | 2.528,93 | 2.657,02 | 2.789,26 | 3.045,45 | 3.561,98 | 3.673,55 | 4.140,50 |

#### VENICE. Chaise longue.

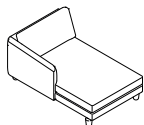

#### VENCLI100

100 x 160 H80  
39.37"x 62.99" H31.50"  
IZQ.

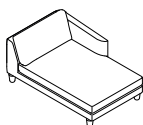

#### VENCLD100

100 x 160 H80  
39.37"x 62.99" H31.50"  
DER.

| MEASUREMENT. MESURE. MEDIDA.           | REF.                  | M.L. | COM / COL | 1        | 2        | 3        | 4        | 5        | L1       | L2       |
|--|-----------------------|------|-----------|----------|----------|----------|----------|----------|----------|----------|
| 100 x 160 H80   39.37"x 62.99" H31.50" | VENCLI100 - VENCLD100 | 6    | 2.140,50  | 2.239,67 | 2.309,92 | 2.404,96 | 2.657,02 | 2.938,02 | 3.008,26 | 3.326,45 |

#### VENICE. Ottomans. Poufs. Ottomans.

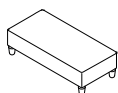

#### VENP66

66 x 137 H36  
25.98"x 53.94" H14.17"

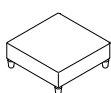

#### VENP98

98 x 98 H36  
38.58"x 38.58" H14.17"

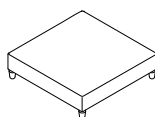

#### VENP137

137 x 137 H36  
53.94"x 53.94" H14.17"

| MEASUREMENT. MESURE. MEDIDA.           | REF.    | M.L. | COM / COL | 1        | 2        | 3        | 4        | 5        | L1       | L2       |
|--|---------|------|-----------|----------|----------|----------|----------|----------|----------|----------|
| 66 x 137 H36   25.98"x 53.94" H14.17"  | VENP66  | 2    | 896,69    | 917,36   | 950,41   | 966,94   | 1.020,66 | 1.115,70 | 1.123,97 | 1.223,14 |
| 98 x 98 H36   38.58"x 38.58" H14.17"   | VENP98  | 3    | 855,37    | 896,69   | 917,36   | 950,41   | 1.004,13 | 1.123,97 | 1.144,63 | 1.239,67 |
| 137 x 137 H36   53.94"x 53.94" H14.17" | VENP137 | 3.5  | 1.115,70  | 1.123,97 | 1.161,16 | 1.231,40 | 1.285,12 | 1.458,68 | 1.475,21 | 1.615,70 |

# VENICE.

# SOFA. CANAPÉ. SOFÁ.



Designer  
Mario Ruiz

STYLE. ESTILO.  
New Classic

VERSION. VERSIÓN.  
Fabric cover version. Version jupe. Versión faldón.

## FEATURES. TRAITS. CARACTERÍSTICAS.

---

Completely removable upholstery.  
Not available in leather.

Wooden frame covered with flexible cold shaped polyurethane foam and polyester fibre.

Suspension consisting of elasticated webbing in different tensions.

Seat cushion made with polyurethane foam inserts, padded with fibre and washed, sterilised down. Back cushions stuffed with polyester fibre and washed, sterilised down.

Metal bases coated with polyester powder paint and a manganese topcoat with LDPE stops or solid oak bases.

Tapiserie entièrement déhoussable.  
Non-disponible en cuir.

Cadre en bois recouvert de mousse de polyuréthane souple à froid et de fibre de polyester.

Suspension au moyen de sangles élastiques entrelacées de différentes tensions.

Coussin de l'assise garnis de mousse polyuréthane, matelassé avec de la fibre et des plumes lavées et stérilisées. Coussins du dossier garnis de fibre de polyester et plumes lavées et stérilisées.

Bases métalliques recouverts en peinture polyester en poudre finition manganèse avec butées en PEBD ou bases en chêne massif.

Tapicería totalmente desenfundable.  
No disponible en piel.

Bastidor de madera recubierto de espuma de poliuretano flexible en frío y fibra de poliéster.

Suspensión mediante cinchas elásticas entrelazadas de diferentes tensiones.

Cojín de asiento realizado con inserto de espuma de poliuretano, acolchado con fibra y pluma lavada y esterilizada. Cojines de respaldo rellenos de fibra de poliéster y pluma lavada y esterilizada.

Bases metálicas recubiertas en pintura poliéster en polvo acabado manganeso con topes de LDPE o bases en roble macizo.



## VENICE.

### GENERAL MEASUREMENTS. MESURES GÉNÉRALES. MEDIDAS GENERALES.

---

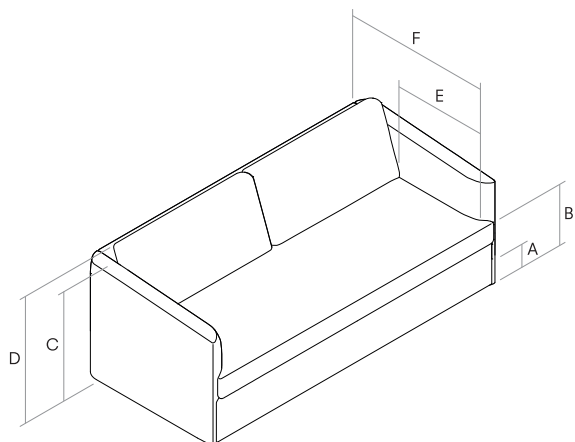

- A. Base height. Hauteur de la base. Altura de la pata. 15 cm - 5.91"
- B. Seat height. Hauteur du siège. Altura de asiento. 44 cm - 17.32"
- C. Arm height. Hauteur du bras. Altura de brazo. 62 cm - 24.41"
- D. Backrest height. Hauteur du dossier. Altura de respaldo. 80 cm - 31.50"
- E. Seat depth. Profondeur d'assise. Profundidad de sentada. 62 cm - 24.41"
- F. Depth. Profondeur. Profundidad. 94 cm - 37.01"

### FINISHES. TRAITS. ACABADOS.

---

Finishes for the metal bases. Finitions des pieds métalliques. Acabados de las patas metálicas.

---

Polyester powder paint. Peinture polyester en poudre. Pintura poliéster en polvo.

---



Manganese metal.  
Métal manganèse.  
Metal manganeso.

Finishes for the wooden feet. Finitions des pieds en bois. Acabados de los pies en madera.

---

Wood finishes. Finitions bois. Acabado de la madera.

---



Natural oak.  
Chêne naturel.  
Roble natural.

## VENICE.

PRICES. PRIX. PRECIOS.

VENICE. Sofas. Canapés. Sofás.

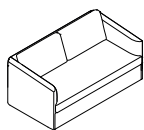

**VENS168FA**

168 x 94 H80  
66.14" x 37.01" H31.50"

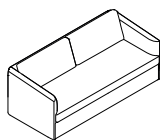

**VENS200FA**

200 x 94 H80  
78.74" x 37.01" H31.50"

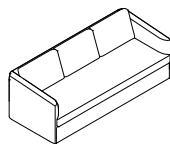

**VENS218FA**

218 x 94 H80  
85.83" x 37.01" H31.50"

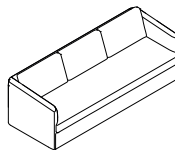

**VENS242FA**

242 x 94 H80  
95.28" x 37.01" H31.50"

| MEASUREMENT. MESURE. MEDIDA.           | REF.      | M.L. | COM / COL | 1        | 2        | 3        | 4        | 5        |
|--|-----------|------|-----------|----------|----------|----------|----------|----------|
| 168 x 94 H80   66.14" x 37.01" H31.50" | VENS168FA | 9.5  | 2.342,98  | 2.450,41 | 2.615,70 | 2.739,67 | 3.061,98 | 3.640,50 |
| 200 x 94 H80   78.74" x 37.01" H31.50" | VENS200FA | 9.5  | 2.528,93  | 2.640,50 | 2.789,26 | 2.929,75 | 3.210,74 | 3.822,31 |
| 218 x 94 H80   85.83" x 37.01" H31.50" | VENS218FA | 10   | 2.694,21  | 2.797,52 | 2.975,21 | 3.148,76 | 3.500,00 | 4.132,23 |
| 242 x 94 H80   95.28" x 37.01" H31.50" | VENS242FA | 11   | 2.888,43  | 2.983,47 | 3.165,29 | 3.326,45 | 3.648,76 | 4.322,31 |

VENICE. Sofas with 1 arm. Canapés avec 1 accoudoir. Sofás con 1 brazo.

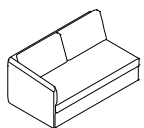

**VENS1158FA**

158 x 94 H80  
62.20" x 37.01" H31.50"  
IZQ.

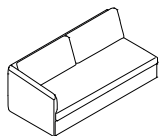

**VENS1190FA**

190 x 94 H80  
74.80" x 37.01" H31.50"  
IZQ.

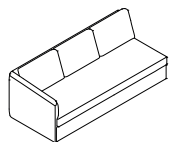

**VENS1208FA**

208 x 94 H80  
81.89" x 37.01" H31.50"  
IZQ.

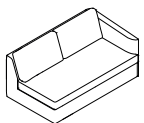

**VENS1158FA**

158 x 94 H80  
62.20" x 37.01" H31.50"  
DER.

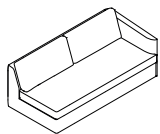

**VENS1190FA**

190 x 94 H80  
74.80" x 37.01" H31.50"  
DER.

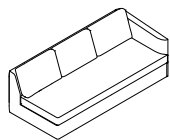

**VENS1208FA**

208 x 94 H80  
81.89" x 37.01" H31.50"  
DER.

| MEASUREMENT. MESURE. MEDIDA.           | REF.                    | M.L. | COM / COL | 1        | 2        | 3        | 4        | 5        |
|--|-------------------------|------|-----------|----------|----------|----------|----------|----------|
| 158 x 94 H80   62.20" x 37.01" H31.50" | VENS1158FA - VENS1158FA | 8    | 2.099,17  | 2.202,48 | 2.309,92 | 2.450,41 | 2.710,74 | 3.202,48 |
| 190 x 94 H80   74.80" x 37.01" H31.50" | VENS1190FA - VENS1190FA | 8.5  | 2.289,26  | 2.404,96 | 2.500,00 | 2.640,50 | 2.888,43 | 3.392,56 |
| 208 x 94 H80   81.89" x 37.01" H31.50" | VENS1208FA - VENS1208FA | 9.5  | 2.421,49  | 2.528,93 | 2.657,02 | 2.789,26 | 3.045,45 | 3.570,25 |

## VENICE.

### PRICES. PRIX. PRECIOS.

#### VENICE. Corner. Angle. Rincón.

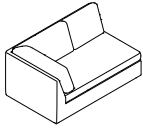

**VENRI168FA**

168 x 94 H80  
66.14"x 37.01" H31.50"  
IZQ.

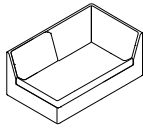

**VENRD168FA**

168 x 94 H80  
66.14"x 37.01" H31.50"  
DER.

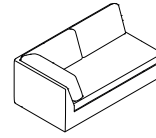

**VENRI184FA**

168 x 94 H80  
72.44"x 37.01" H31.50"  
IZQ.

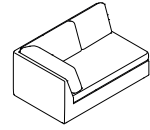

**VENRD184FA**

168 x 94 H80  
72.44"x 37.01" H31.50"  
DER.

| MEASUREMENT. MESURE. MEDIDA.          | REF.                    | M.L. | COM / COL | 1        | 2        | 3        | 4        | 5        |
|---------------------------------------|-------------------------|------|-----------|----------|----------|----------|----------|----------|
| 168 x 94 H80   66.14"x 37.01" H31.50" | VENRI168FA - VENRD168FA | 9.5  | 2.239,67  | 2.359,50 | 2.500,00 | 2.657,02 | 2.929,75 | 3.508,26 |
| 184 x 94 H80   72.44"x 37.01" H31.50" | VENRI184FA - VENRD184FA | 10   | 2.421,49  | 2.528,93 | 2.657,02 | 2.789,26 | 3.086,78 | 3.673,55 |

#### VENICE. Chaise longue.

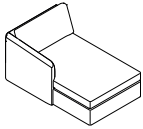

**VENCLI100FA**

100 x 160 H80  
39.37"x 62.99" H31.50"  
IZQ.

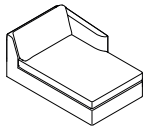

**VENCLD100FA**

100 x 160 H80  
39.37"x 62.99" H31.50"  
DER.

| MEASUREMENT. MESURE. MEDIDA.           | REF.                      | M.L. | COM / COL | 1        | 2        | 3        | 4        | 5        |
|--|---------------------------|------|-----------|----------|----------|----------|----------|----------|
| 100 x 160 H80   39.37"x 62.99" H31.50" | VENCLI100FA - VENCLD100FA | 7    | 2.099,17  | 2.140,50 | 2.247,93 | 2.359,50 | 2.553,72 | 2.954,55 |

#### VENICE. Ottomans. Poufs. Ottomans.

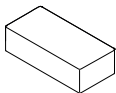

**VENP66FA**

66 x 137 H36  
25.98"x 53.94" H14.17"

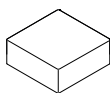

**VENP98FA**

98 x 98 H36  
38.58"x 38.58" H14.17"

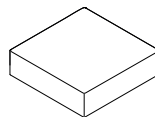

**VENP137FA**

137 x 137 H36  
53.94"x 53.94" H14.17"

| MEASUREMENT. MESURE. MEDIDA.           | REF.      | M.L. | COM / COL | 1        | 2        | 3        | 4        | 5        |
|--|-----------|------|-----------|----------|----------|----------|----------|----------|
| 66 x 137 H36   25.98"x 53.94" H14.17"  | VENP66FA  | 2.5  | 809,92    | 834,71   | 855,37   | 896,69   | 966,94   | 1.107,44 |
| 98 x 98 H36   38.58"x 38.58" H14.17"   | VENP98FA  | 3.5  | 855,37    | 896,69   | 917,36   | 950,41   | 1.004,13 | 1.115,70 |
| 137 x 137 H36   53.94"x 53.94" H14.17" | VENP137FA | 4    | 1.074,38  | 1.123,97 | 1.161,16 | 1.177,69 | 1.285,12 | 1.458,68 |

# BOUVIER.

# ARMCHAIR. FAUTEUIL. BUTACA.



Designer  
Dario Gagliardini

STYLE. ESTILO.  
Essential

## FEATURES. TRAITS. CARACTERÍSTICAS.

---

Fixed upholstery. Back cushion with removable cover.

Wooden frame covered with flexible cold shaped polyurethane foam and polyester fibre.

Suspension consisting of elasticated webbing in different tensions.

Seat made in different polyurethane foam densities and surface padding in fibre. Back cushion stuffed with polyester fibre and washed, sterilised down.

Two types of bases to choose from: a cross metal base with LDPE stops or a flat disc metal base with felt. All metallic elements are coated with manganese coloured polyester powder paint.

Tapiserie fixé. Coussin du dossier déhoussable.

Cadre en bois recouvert de mousse de polyuréthane souple à froid et de fibre de polyester.

Suspension au moyen de sangles élastiques entrelacées de différentes tensions.

Assise réalisée dans différentes densités de mousse polyuréthane, matelassée en surface avec fibre. Coussin du dossier garnis de fibre de polyester et plumes lavées et stérilisées.

Deux types de bases sont proposés: base métallique en croix avec patins en PEBD ou base métallique avec socle rond recouvert de feutre. Tous les éléments métalliques sont recouverts de peinture polyester en poudre couleur manganèse.

Tapicería fija. Cojín de respaldo desenfundable.

Bastidor de madera recubierto de espuma de poliuretano flexible en frío y fibra de poliéster.

Suspensión mediante cinchas elásticas entrelazadas de diferentes tensiones.

Asiento realizado en distintas densidades de espuma de poliuretano, acolchado en la superficie con fibra. Cojín de respaldo relleno de fibra de poliéster y pluma lavada y esterilizada.

Dos tipos de bases a escoger: Base metálica en cruz con topes de LDPE o base metálica de disco con fieltro. Todos los elementos metálicos están recubiertos en pintura poliéster en polvo color manganeso.

## BOUVIER.

### GENERAL MEASUREMENTS. MESURES GÉNÉRALES. MEDIDAS GENERALES.

---

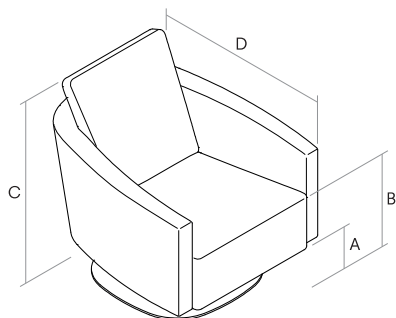

- A. Base height. Hauteur de base. Altura de base. 17 cm - 6.69"
- B. Seat height. Hauteur du siège. Altura de asiento. 41 cm - 16.14"
- C. Backrest height. Hauteur du dossier. Altura de respaldo. 83 cm - 32.68"
- D. Depth. Profondeur. Profundidad. 87 cm - 34.25"

### FINISHES. TRAITS. ACABADOS.

---

Finishes for the metal bases. Finitions des bases métalliques. Acabados de las bases metálicas.

---

Polyester powder paint. Peinture polyester en poudre. Pintura poliéster en polvo.

---



Manganese metal.  
Métal manganèse.  
Metal manganeso.

## BOUVIER.

PRICES. PRIX. PRECIOS.

BOUVIER. Armchairs. Fauteuils. Butacas.



### BOUB74FP

74 x 87 H83  
29.13" x 34.25" H32.67"

Flat metal base, fixed.  
Base métallique avec socle plat, fixe.  
Base metálica plana fija.



### BOUB74FC

74 x 87 H83  
29.13" x 34.25" H32.67"

Cross-shaped metal base, fixed.  
Base métallique en croix, fixe.  
Base metálica en cruz fija.



### BOUB74GP

74 x 87 H83  
29.13" x 34.25" H32.67"

Flat metal base rotating with auto-return. Base métallique avec socle plat pivotante avec retour automatique.  
Base metálica plana giratoria con retorno.



### BOUB74GC

74 x 87 H83  
29.13" x 34.25" H32.67"

Cross-shaped metal base rotating with auto-return. Base métallique en croix, pivotante avec retour automatique. Base metálica en cruz giratoria con retorno.

| MEASUREMENT. MESURE. MEDIDA.          | REF.     | M.L. | COM / COL | 1        | 2        | 3        | 4        | 5        | L1       | L2       |
|---------------------------------------|----------|------|-----------|----------|----------|----------|----------|----------|----------|----------|
| 74 x 87 H83   29.13" x 34.25" H32.67" | BOUB74FP | 4    | 1.404,96  | 1.433,88 | 1.491,74 | 1.537,19 | 1.632,23 | 1.826,45 | 1.871,90 | 2.028,93 |
| 74 x 87 H83   29.13" x 34.25" H32.67" | BOUB74FC | 4    | 1.404,96  | 1.433,88 | 1.491,74 | 1.537,19 | 1.632,23 | 1.826,45 | 1.871,90 | 2.028,93 |
| 74 x 87 H83   29.13" x 34.25" H32.67" | BOUB74GP | 4    | 1.466,94  | 1.512,40 | 1.545,45 | 1.599,17 | 1.694,21 | 1.880,17 | 1.929,75 | 2.090,91 |
| 74 x 87 H83   29.13" x 34.25" H32.67" | BOUB74GC | 4    | 1.466,94  | 1.512,40 | 1.545,45 | 1.599,17 | 1.694,21 | 1.880,17 | 1.929,75 | 2.090,91 |



# DECK.

# ARMCHAIR. FAUTEUIL. BUTACA.



Designer  
Mario Ruiz

STYLE. ESTILO.  
Singular

VERSION. VERSIÓN.  
Wood exterior. Structure extérieur en bois. Estructura exterior de madera.

## FEATURES. TRAITS. CARACTERÍSTICAS.

---

Removable upholstery in seat base, seat and back. In leather, seat and back with removable covers.

Wooden frame covered with flexible cold shaped polyurethane foam and polyester fibre.

Suspension consisting of elasticated webbing in different tensions.

External MDF, ultralight American walnut veneer, or dark-dyed oak. Upholstered interior.

Seat cushion in different polyurethane foam densities, with surface padding in fibre. Back cushion stuffed with polyester fibre and washed, sterilised down.

Three types of bases to choose from: U-shaped metal feet with LDPE stops, a cross metal base with LDPE stops, or a flat disc metal base with felt. All metallic elements are coated with manganese coloured polyester powder paint.

Tapiserie déhoussable sur la base de l'assise, coussin de l'assise et du dossier. En cuir, coussin de l'assise et du dossier déhoussables.

Cadre en bois recouvert de mousse de polyuréthane souple à froid et de fibre de polyester.

Suspension au moyen de sangles élastiques entrelacées de différentes tensions.

Structure extérieure en MDF ultraléger noyer plaqué américain ou chêne teinté de couleur foncée. Intérieur tapissé.

Coussin de l'assise réalisé dans différentes densités de mousse polyuréthane, matelassé en surface avec du fibre. Coussin du dossier garni de fibre de polyester et plumes lavées et stérilisées.

Trois types de bases sont proposés : pieds en métal en forme de U avec patins en PEBD, base métallique en croix avec patins en PEBD ou base métallique avec socle rond recouvert de feutre. Tous les éléments métalliques sont recouverts de peinture polyester en poudre avec finition manganèse.

Tapicería desenfundable en base de asiento, cojín de asiento y cojín de respaldo. En piel, cojín de asiento y cojín de respaldo desenfundables.

Bastidor de madera recubierto de espuma de poliuretano flexible en frío y fibra de poliéster.

Suspensión mediante cinchas elásticas entrelazadas de diferentes tensiones.

Estructura exterior en MDF ultraligero chapado en nogal americano o roble tintado oscuro. Interior tapizado.

Cojín de asiento realizado en distintas densidades de espuma de poliuretano, acolchado en la superficie con fibra. Cojín de respaldo relleno de fibra de poliéster y pluma lavada y esterilizada.

Tres tipos de bases a escoger: pies metálicos en forma de U con topes de LDPE, base metálica en cruz con topes de LDPE o base metálica de disco con fieltro. Todos los elementos metálicos están recubiertos en pintura poliéster en polvo color manganeso.



## DECK.

### GENERAL MEASUREMENTS. MESURES GÉNÉRALES. MEDIDAS GENERALES.

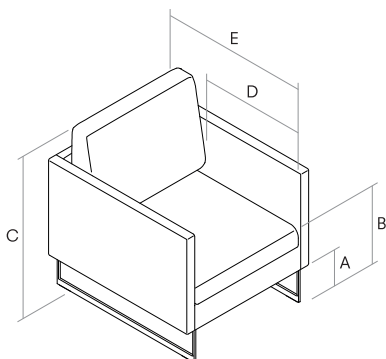

- A. Base height. Hauteur de base. Altura de base. 17 cm - 6.69"
- B. Seat height. Hauteur du siège. Altura de asiento. 42 cm - 16.54"
- C. Backrest height. Hauteur du dossier. Altura de respaldo. 83 cm - 32.68"
- D. Seat depth. Profondeur d'assise. Profundidad de asiento. 50 cm - 19.69"
- E. Depth. Profondeur. Profundidad. 76 cm - 29.92"

### FINISHES. TRAITS. ACABADOS.

Finishes for the metal feet. Finitions des pieds métalliques. Acabados de las patas metálicas.

Polyester powder paint. Peinture polyester en poudre. Pintura poliéster en polvo.



Manganese metal.  
Métal manganèse.  
Metal manganeso.

Finishes for the external wooden structure. Finitions de la structure extérieure en bois. Acabados de las estructura exterior de madera.

Wood finishes. Finitions bois. Acabado de la madera.



**RN**  
Natural oak.  
Chêne naturel.  
Roble natural.



**NA**  
Natural american walnut.  
Noyer américain.  
Nogal americano.



**RT**  
Dark stained oak.  
Chêne teint foncée.  
Roble teñido oscuro.



**RL**  
Oak painted in black with open-pore finish.  
Chêne laqué noir à pores ouverts.  
Roble lacado negro por abierto.

How to complete the reference. Comment remplir la référence. Cómo completar la referencia.

Example. Exemple. Ejemplo.

1. Select the product. Sélectionner le produit.  
Seleccionar el producto.

2. Select the finish. Sélectionner le finition.  
Seleccionar el acabado.

3. Reference completed. Référence remplie.  
Referencia completada.

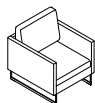

**DECB74BE**  
74 x 76 H83  
29.13" x 29.92" H32.67"



**NA**  
Natural american walnut.  
Noyer américain.  
Nogal americano.

**DECB74BENA**  
DECK armchair, 74 cm, natural american walnut.  
Fauteuil DECK, 74 cm, noyer américain..  
Butaca DECK, 74 cm, nogal americano.

## DECK.

### PRICES. PRIX. PRECIOS.

#### DECK. Armchairs. Fauteuils. Butacas.

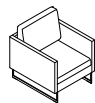

#### DEC B74BE

74 x 76 H83  
29.13" x 29.92" H32.67"

Standard metal bases. Wood exterior.  
Bases métalliques standard. Structure  
extérieur en bois. Bases metálicas  
standard. Estructura exterior de  
madera.



#### DEC B74FP

74 x 76 H83  
29.13" x 29.92" H32.67"

Flat metal base, fixed. Wood exterior.  
Base métallique avec socle plat, fixe.  
Structure extérieur en bois. Base  
metálica plana fija. Estructura exterior  
de madera.

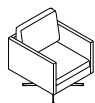

#### DEC B74FC

74 x 76 H83  
29.13" x 29.92" H32.67"

Cross-shaped metal base, fixed.  
Wood exterior. Base métallique en  
croix, fixe. Structure extérieur en bois.  
Base metálica en cruz fija. Estructura  
exterior de madera.



#### DEC B74GP

74 x 76 H83  
29.13" x 29.92" H32.67"

Flat metal base rotating with auto-  
return. Wood exterior. Base métallique  
avec socle plat pivotante avec retour  
automatique. Structure extérieur en  
bois. Base metálica plana giratoria con  
retorno. Estructura exterior de madera.

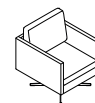

#### DEC B74GC

74 x 76 H83  
29.13" x 29.92" H32.67"

Cross-shaped metal base rotating  
with auto-return. Wood exterior.  
Base métallique en croix, pivotante  
avec retour automatique. Structure  
extérieur en bois. Base metálica en  
cruz giratoria con retorno. Estructura  
exterior de madera.

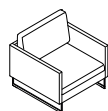

#### DEC B90BE

90 x 76 H83  
35.43" x 29.92" H32.67"

Standard metal bases. Wood exterior.  
Bases métalliques standard. Structure  
extérieur en bois. Bases metálicas  
standard. Estructura exterior de  
madera.

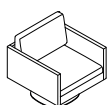

#### DEC B90FP

90 x 76 H83  
35.43" x 29.92" H32.67"

Flat metal base, fixed. Wood exterior.  
Base métallique avec socle plat, fixe.  
Structure extérieur en bois. Base  
metálica plana fija. Estructura exterior  
de madera.

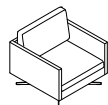

#### DEC B90FC

90 x 76 H83  
35.43" x 29.92" H32.67"

Cross-shaped metal base, fixed.  
Wood exterior. Base métallique en  
croix, fixe. Structure extérieur en bois.  
Base metálica en cruz fija. Estructura  
exterior de madera.

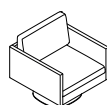

#### DEC B90GP

90 x 76 H83  
35.43" x 29.92" H32.67"

Flat metal base rotating with auto-  
return. Wood exterior. Base métallique  
avec socle plat pivotante avec retour  
automatique. Structure extérieur en  
bois. Base metálica plana giratoria con  
retorno. Estructura exterior de madera.

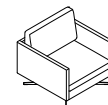

#### DEC B90GC

90 x 76 H83  
35.43" x 29.92" H32.67"

Cross-shaped metal base rotating  
with auto-return. Wood exterior.  
Base métallique en croix, pivotante  
avec retour automatique. Structure  
extérieur en bois. Base metálica en  
cruz giratoria con retorno. Estructura  
exterior de madera.

| MEASUREMENT. MESURE. MEDIDA.          | REF.      | M.L. | COM / COL | 1        | 2        | 3        | 4        | 5        | L1       | L2       |
|---------------------------------------|-----------|------|-----------|----------|----------|----------|----------|----------|----------|----------|
| 74 x 76 H83   29.13" x 29.92" H32.67" | DEC B74BE | 4    | 1.896,69  | 1.942,15 | 2.049,59 | 2.095,04 | 2.219,01 | 2.520,66 | 2.590,91 | 2.698,35 |
| 74 x 76 H83   29.13" x 29.92" H32.67" | DEC B74FP | 4    | 2.049,59  | 2.128,10 | 2.181,82 | 2.219,01 | 2.380,17 | 2.644,63 | 2.743,80 | 2.814,05 |
| 74 x 76 H83   29.13" x 29.92" H32.67" | DEC B74FC | 4    | 2.049,59  | 2.128,10 | 2.181,82 | 2.219,01 | 2.380,17 | 2.644,63 | 2.743,80 | 2.814,05 |
| 74 x 76 H83   29.13" x 29.92" H32.67" | DEC B74GP | 4    | 2.165,29  | 2.227,27 | 2.334,71 | 2.351,24 | 2.475,21 | 2.780,99 | 2.842,98 | 2.942,15 |
| 74 x 76 H83   29.13" x 29.92" H32.67" | DEC B74GC | 4    | 2.165,29  | 2.227,27 | 2.334,71 | 2.351,24 | 2.475,21 | 2.780,99 | 2.842,98 | 2.942,15 |
| 90 x 76 H83   35.43" x 29.92" H32.67" | DEC B90BE | 4.5  | 2.020,66  | 2.128,10 | 2.181,82 | 2.227,27 | 2.396,69 | 2.752,07 | 2.797,52 | 2.904,96 |
| 90 x 76 H83   35.43" x 29.92" H32.67" | DEC B90FP | 4.5  | 2.136,36  | 2.210,74 | 2.289,26 | 2.334,71 | 2.475,21 | 2.789,26 | 2.867,77 | 2.966,94 |
| 90 x 76 H83   35.43" x 29.92" H32.67" | DEC B90FC | 4.5  | 2.136,36  | 2.210,74 | 2.289,26 | 2.334,71 | 2.475,21 | 2.789,26 | 2.867,77 | 2.966,94 |
| 90 x 76 H83   35.43" x 29.92" H32.67" | DEC B90GP | 4.5  | 2.252,07  | 2.318,18 | 2.421,49 | 2.433,88 | 2.590,91 | 2.942,15 | 3.004,13 | 3.074,38 |
| 90 x 76 H83   35.43" x 29.92" H32.67" | DEC B90GC | 4.5  | 2.252,07  | 2.318,18 | 2.421,49 | 2.433,88 | 2.590,91 | 2.942,15 | 3.004,13 | 3.074,38 |





Designer  
Mario Ruiz

STYLE. ESTILO.  
Singular

VERSION. VERSIÓN.  
Upholstered exterior. Structure extérieure tapissée. Estructura exterior tapizada.

## FEATURES. TRAITS. CARACTERÍSTICAS.

Complete removable upholstery. In leather, seat and back with removable covers.

Wooden frame covered with flexible cold shaped polyurethane foam and polyester fibre.

Suspension consisting of elasticated webbing in different tensions.

Seat cushion in different polyurethane foam densities, with surface padding in fibre. Back cushion stuffed with polyester fibre and washed, sterilised down.

Three types of bases to choose from: U-shaped metal feet with LDPE stops, a cross metal base with LDPE stops, or a flat disc metal base with felt. All metallic elements are coated with manganese coloured polyester powder paint.

Tapiserie entièrement déhoussable. En cuir, coussins de l'assise et du dossier déhoussables.

Cadre en bois recouvert de mousse de polyuréthane souple à froid et de fibre de polyester.

Suspension au moyen de sangles élastiques entrelacées de différentes tensions.

Coussin de l'assise réalisé dans différentes densités de mousse polyuréthane, matelassé en surface avec du fibre. Coussin du dossier garni de fibre de polyester et de plumes lavées et stérilisées.

Trois types de bases sont proposés : pieds en métal en forme de U avec patins en PEBD, base métallique en croix avec patins en PEBD ou base métallique avec socle rond recouvert de feutre. Tous les éléments métalliques sont recouverts de peinture polyester en poudre avec finition manganèse.

Tapicería totalmente desfundable. En piel, cojín de asiento y cojín de respaldo desfundables.

Bastidor de madera recubierto de espuma de poliuretano flexible en frío y fibra de poliéster.

Suspensión mediante cinchas elásticas entrelazadas de diferentes tensiones.

Cojín de asiento realizado en distintas densidades de espuma de poliuretano, acolchado en la superficie con fibra. Cojín de respaldo relleno de fibra de poliéster y pluma lavada y esterilizada.

Tres tipos de bases a escoger: pies metálicos en forma de U con topes de LDPE, base metálica en cruz con topes de LDPE o base metálica de disco con fieltro. Todos los elementos metálicos están recubiertos en pintura poliéster en polvo color manganeso.

## DECK.

### GENERAL MEASUREMENTS. MESURES GÉNÉRALES. MEDIDAS GENERALES.

---

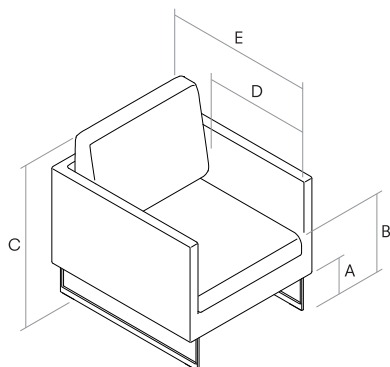

- A.** Base height. Hauteur de base. Altura de base. 17 cm - 6.69"
- B.** Seat height. Hauteur du siège. Altura de asiento. 42 cm - 16.54"
- C.** Backrest height. Hauteur du dossier. Altura de respaldo. 83 cm - 32.68"
- D.** Seat depth. Profondeur d'assise. Profundidad de asiento. 50 cm - 19.69"
- E.** Depth. Profondeur. Profundidad. 76 cm - 29.92"

### FINISHES. TRAITS. ACABADOS.

---

Finishes for the metal bases. Finitions des pieds métalliques. Acabados de las patas metálicas.

---

Polyester powder paint. Peinture polyester en poudre. Pintura poliéster en polvo.

---



Manganese metal.  
Métal manganèse.  
Metal manganeso.

## DECK.

### PRICES. PRIX. PRECIOS.

#### DECK. Armchairs. Fauteuils. Butacas.

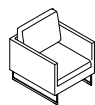

#### DEC B74T ABE

74 x 76 H83  
29.13" x 29.92" H32.67"

Standard metal bases. Upholstered exterior. Bases métalliques standard. Structure extérieur tapissée. Bases metálicas standard. Estructura exterior tapizada.



#### DEC B74T AFB

74 x 76 H83  
29.13" x 29.92" H32.67"

Flat metal base, fixed. Upholstered exterior. Base métallique avec socle plat, fixe. Structure extérieur tapissée. Base metálica plana fija. Estructura exterior tapizada.

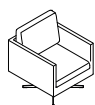

#### DEC B74T AFC

74 x 76 H83  
29.13" x 29.92" H32.67"

Cross-shaped metal base, fixed. Upholstered exterior. Base métallique en croix, fixe. Structure extérieur tapissée. Base metálica en cruz fija. Estructura exterior tapizada.



#### DEC B74T AGP

74 x 76 H83  
29.13" x 29.92" H32.67"

Flat metal base rotating with auto-return. Upholstered exterior. Base métallique avec socle plat pivotante avec retour automatique. Structure extérieur tapissée. Base metálica plana giratoria con retorno. Estructura exterior tapizada.

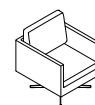

#### DEC B74T AGC

74 x 76 H83  
29.13" x 29.92" H32.67"

Cross-shaped metal base rotating with auto-return. Upholstered exterior. Base métallique en croix, pivotante avec retour automatique. Structure extérieur tapissée. Base metálica en cruz giratoria con retorno. Estructura exterior tapizada.

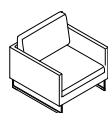

#### DEC B90T ABE

90 x 76 H83  
35.43" x 29.92" H32.67"

Standard metal bases. Upholstered exterior. Bases métalliques standard. Structure extérieur tapissée. Bases metálicas standard. Estructura exterior tapizada.

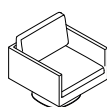

#### DEC B90T AFB

90 x 76 H83  
35.43" x 29.92" H32.67"

Flat metal base, fixed. Upholstered exterior. Base métallique avec socle plat, fixe. Structure extérieur tapissée. Base metálica plana fija. Estructura exterior tapizada.

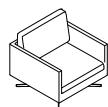

#### DEC B90T AFC

90 x 76 H83  
35.43" x 29.92" H32.67"

Cross-shaped metal base, fixed. Upholstered exterior. Base métallique en croix, fixe. Structure extérieur tapissée. Base metálica en cruz fija. Estructura exterior tapizada.

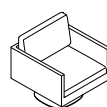

#### DEC B90T AGP

90 x 76 H83  
35.43" x 29.92" H32.67"

Flat metal base rotating with auto-return. Upholstered exterior. Base métallique avec socle plat pivotante avec retour automatique. Structure extérieur tapissée. Base metálica plana giratoria con retorno. Estructura exterior tapizada.

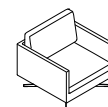

#### DEC B90T AGC

90 x 76 H83  
35.43" x 29.92" H32.67"

Cross-shaped metal base rotating with auto-return. Upholstered exterior. Base métallique en croix, pivotante avec retour automatique. Structure extérieur tapissée. Base metálica en cruz giratoria con retorno. Estructura exterior tapizada.

| MEASUREMENT. MESURE. MEDIDA.          | REF.         | M.L. | COM / COL | 1        | 2        | 3        | 4        | 5        | L1       | L2       |
|---------------------------------------|--------------|------|-----------|----------|----------|----------|----------|----------|----------|----------|
| 74 x 76 H83   29.13" x 29.92" H32.67" | DEC B74T ABE | 5    | 1.404,96  | 1.504,13 | 1.553,72 | 1.661,16 | 1.789,26 | 2.099,17 | 2.140,50 | 2.413,22 |
| 74 x 76 H83   29.13" x 29.92" H32.67" | DEC B74T AFB | 5    | 1.458,68  | 1.512,40 | 1.561,98 | 1.632,23 | 1.780,99 | 2.028,93 | 2.107,44 | 2.334,71 |
| 74 x 76 H83   29.13" x 29.92" H32.67" | DEC B74T AFC | 5    | 1.458,68  | 1.512,40 | 1.561,98 | 1.632,23 | 1.780,99 | 2.028,93 | 2.107,44 | 2.334,71 |
| 74 x 76 H83   29.13" x 29.92" H32.67" | DEC B74T AGP | 5    | 1.545,45  | 1.590,91 | 1.677,69 | 1.747,93 | 1.880,17 | 2.140,50 | 2.185,95 | 2.450,41 |
| 74 x 76 H83   29.13" x 29.92" H32.67" | DEC B74T AGC | 5    | 1.545,45  | 1.590,91 | 1.677,69 | 1.747,93 | 1.880,17 | 2.140,50 | 2.185,95 | 2.450,41 |
| 90 x 76 H83   35.43" x 29.92" H32.67" | DEC B90T ABE | 6    | 1.433,88  | 1.520,66 | 1.561,98 | 1.652,89 | 1.801,65 | 2.115,70 | 2.148,76 | 2.429,75 |
| 90 x 76 H83   35.43" x 29.92" H32.67" | DEC B90T AFB | 6    | 1.520,66  | 1.582,64 | 1.652,89 | 1.731,40 | 1.863,64 | 2.148,76 | 2.210,74 | 2.466,94 |
| 90 x 76 H83   35.43" x 29.92" H32.67" | DEC B90T AFC | 6    | 1.520,66  | 1.582,64 | 1.652,89 | 1.731,40 | 1.863,64 | 2.148,76 | 2.210,74 | 2.466,94 |
| 90 x 76 H83   35.43" x 29.92" H32.67" | DEC B90T AGP | 6    | 1.607,44  | 1.669,42 | 1.747,93 | 1.801,65 | 1.950,41 | 2.256,20 | 2.318,18 | 2.561,98 |
| 90 x 76 H83   35.43" x 29.92" H32.67" | DEC B90T AGC | 6    | 1.607,44  | 1.669,42 | 1.747,93 | 1.801,65 | 1.950,41 | 2.256,20 | 2.318,18 | 2.561,98 |



# ETHOS.

# ARMCHAIR. FAUTEUIL. BUTACA.



Designer  
Mario Ruiz

STYLE. ESTILO.  
Singular

## FEATURES. TRAITS. CARACTERÍSTICAS.

---

### Fixed upholstery.

Combined wood and metal frame covered with flexible cold shaped polyurethane foam and polyester fibre.

Seat, back, headrest and arms in different polyurethane foam densities, with surface padding in fibre.

Two types of bases to choose from: a cross metal base with LDPE stops or a flat disc metal base with felt. All metallic elements are coated with manganese coloured polyester powder paint.

### Tapiserie fixe.

Châssis avec combinaison métal et bois recouvert de mousse de polyuréthane souple à froid et de fibre de polyester.

Assise, dossier, repose-têtes et accoudoirs réalisés dans différentes densités de mousse polyuréthane, matelassés en surface avec du fibre.

Deux types de bases sont proposés: base métallique en croix avec patins en PEBD ou base métallique avec socle rond recouvert de feutre. Tous les éléments métalliques sont recouverts de peinture polyester en poudre couleur manganèse.

### Tapizado fijo.

Bastidor combinado de metal y madera recubierto de espuma de poliuretano flexible en frío y fibra de poliéster.

Asiento, respaldo, reposacabezas y brazos realizados en distintas densidades de espuma de poliuretano, acolchado en la superficie con fibra.

Dos tipos de bases a escoger: Base metálica en cruz con topes de LDPE o base metálica de disco con fieltro. Todos los elementos metálicos están recubiertos en pintura poliéster en polvo color manganeso.



## ETHOS.

### GENERAL MEASUREMENTS. MESURES GÉNÉRALES. MEDIDAS GENERALES.

---

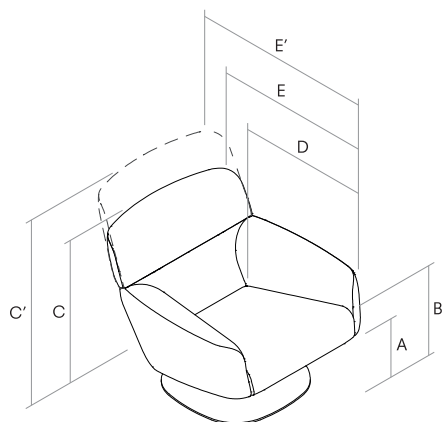

- A.** Base height. Hauteur de base. Altura de base. 27 cm - 10.63"
- B.** Seat height. Hauteur du siège. Altura de asiento. 45 cm - 17.72"
- C.** Backrest height. Hauteur du dossier. Altura de respaldo. 78 cm - 30.71"
- C'.** Backrest height. Hauteur du dossier. Altura de respaldo. 99 cm - 38.98"
- D.** Seat depth. Profondeur d'assise. Profundidad de asiento. 55 cm - 21.65"
- E.** Depth. Profondeur. Profundidad. 90 cm - 35.43"
- E'.** Depth. Profondeur. Profundidad. 95 cm - 37.40"

### FINISHES. TRAITS. ACABADOS.

---

Finishes for the metal bases. Finitions des bases métalliques. Acabados de las bases metálicas.

---

Polyester powder paint. Peinture polyester en poudre. Pintura poliéster en polvo.

---



Manganese metal.  
Métal manganèse.  
Metal manganeso.

# ETHOS.

## PRICES. PRIX. PRECIOS.

### ETHOS. Armchairs. Fauteuils. Butacas.



#### ETHB86RBFP

86 x 90 H78  
33.86" x 35.43" H30.71"

Flat metal base, fixed. Low back.  
Base métallique avec socle plat, fixe.  
Dossier bas. Base metálica plana fija.  
Respaldo bajo.



#### ETHB86RBFC

86 x 90 H78  
33.86" x 35.43" H30.71"

Cross-shaped metal base, fixed. Low back. Base métallique en croix, fixe.  
Dossier bas. Base metálica en cruz fija. Respaldo bajo.



#### ETHB86RBGP

86 x 95 H99  
33.86" x 37.40" H38.98"

Flat metal base rotating with auto-return. Low back. Base métallique avec socle plat pivotante avec retour automatique. Dossier bas. Base metálica plana giratoria con retorno. Respaldo bajo.



#### ETHB86RBGC

86 x 95 H99  
33.86" x 37.40" H38.98"

Cross-shaped metal base rotating with auto-return. Low back. Base métallique en croix, pivotante avec retour automatique. Dossier bas. Base metálica en cruz giratoria con retorno. Respaldo bajo.

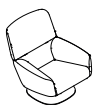

#### ETHB86RAFP

86 x 95 H99  
33.86" x 37.40" H38.98"

Flat metal base, fixed. High back.  
Base métallique avec socle plat, fixe.  
Dossier haut. Base metálica plana fija.  
Respaldo alto.



#### ETHB86RAFC

86 x 95 H99  
33.86" x 37.40" H38.98"

Cross-shaped metal base, fixed. High back. Base métallique en croix, fixe.  
Dossier haut. Base metálica en cruz fija. Respaldo alto.

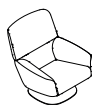

#### ETHB86RAGP

86 x 95 H99  
33.86" x 37.40" H38.98"

Flat metal base rotating with auto-return. High back. Base métallique avec socle plat pivotante avec retour automatique. Dossier haut. Base metálica plana giratoria con retorno. Respaldo alto.



#### ETHB86RAGC

86 x 95 H99  
33.86" x 37.40" H38.98"

Cross-shaped metal base rotating with auto-return. High back. Base métallique en croix, pivotante avec retour automatique. Dossier haut. Base metálica en cruz giratoria con retorno. Respaldo alto.

| MEASUREMENT. MESURE. MEDIDA.          | REF.       | M.L. | COM / COL | 1        | 2        | 3        | 4        | 5        | L1       | L2       |
|---------------------------------------|------------|------|-----------|----------|----------|----------|----------|----------|----------|----------|
| 86 x 90 H78   33.86" x 35.43" H30.71" | ETHB86RBFP | 4    | 1.566,12  | 1.615,70 | 1.648,76 | 1.706,61 | 1.805,79 | 1.971,07 | 2.037,19 | 2.243,80 |
| 86 x 90 H78   33.86" x 35.43" H30.71" | ETHB86RBFC | 4    | 1.566,12  | 1.615,70 | 1.648,76 | 1.706,61 | 1.805,79 | 1.971,07 | 2.037,19 | 2.243,80 |
| 86 x 90 H78   33.86" x 35.43" H30.71" | ETHB86RBGP | 4    | 1.566,12  | 1.615,70 | 1.648,76 | 1.706,61 | 1.805,79 | 1.971,07 | 2.037,19 | 2.243,80 |
| 86 x 90 H78   33.86" x 35.43" H30.71" | ETHB86RBGC | 4    | 1.566,12  | 1.615,70 | 1.648,76 | 1.706,61 | 1.805,79 | 1.971,07 | 2.037,19 | 2.243,80 |
| 86 x 95 H99   33.86" x 37.40" H38.98" | ETHB86RAFP | 4    | 1.623,97  | 1.673,55 | 1.714,88 | 1.772,73 | 1.888,43 | 2.078,51 | 2.144,63 | 2.376,03 |
| 86 x 95 H99   33.86" x 37.40" H38.98" | ETHB86RAFC | 4    | 1.623,97  | 1.673,55 | 1.714,88 | 1.772,73 | 1.888,43 | 2.078,51 | 2.144,63 | 2.376,03 |
| 86 x 95 H99   33.86" x 37.40" H38.98" | ETHB86RAGP | 4    | 1.623,97  | 1.673,55 | 1.714,88 | 1.772,73 | 1.888,43 | 2.078,51 | 2.144,63 | 2.376,03 |
| 86 x 95 H99   33.86" x 37.40" H38.98" | ETHB86RAGC | 4    | 1.623,97  | 1.673,55 | 1.714,88 | 1.772,73 | 1.888,43 | 2.078,51 | 2.144,63 | 2.376,03 |

# ETHOS.

## PRICES. PRIX. PRECIOS.

### ETHOS. Ottomans. Poufs. Ottomans.



#### ETHP65FP

65 x 50 H41  
25.59" x 19.69" H16.14"

Flat metal base, fixed. Base métallique avec socle plat, fixe. Base metálica plana fija.



#### ETHP65FC

65 x 50 H41  
25.59" x 19.69" H16.14"

Cross-shaped metal base, fixed. Base métallique en croix, fixe. Base metálica en cruz fija.



#### ETHP65GP

65 x 50 H41  
25.59" x 19.69" H16.14"

Flat metal base rotating with auto-return. Base métallique avec socle plat pivotante avec retour automatique. Base metálica plana giratoria con retorno.



#### ETHP65GC

65 x 50 H41  
25.59" x 19.69" H16.14"

Cross-shaped metal base rotating with auto-return. Base métallique en croix, pivotante avec retour automatique. Base metálica en cruz giratoria con retorno.

| MEASUREMENT. MESURE. MEDIDA.          | REF.     | M.L. | COM / COL | 1      | 2      | 3      | 4      | 5      | L1     | L2     |
|---------------------------------------|----------|------|-----------|--------|--------|--------|--------|--------|--------|--------|
| 65 x 50 H41   25.59" x 19.69" H16.14" | ETHP65FP | 1    | 549,59    | 566,12 | 574,38 | 582,64 | 615,70 | 657,02 | 673,55 | 723,14 |
| 65 x 50 H41   25.59" x 19.69" H16.14" | ETHP65FC | 1    | 549,59    | 566,12 | 574,38 | 582,64 | 615,70 | 657,02 | 673,55 | 723,14 |
| 65 x 50 H41   25.59" x 19.69" H16.14" | ETHP65GP | 1    | 549,59    | 566,12 | 574,38 | 582,64 | 615,70 | 657,02 | 673,55 | 723,14 |
| 65 x 50 H41   25.59" x 19.69" H16.14" | ETHP65GC | 1    | 549,59    | 566,12 | 574,38 | 582,64 | 615,70 | 657,02 | 673,55 | 723,14 |

# GREY.

# ARMCHAIR. FAUTEUIL. BUTACA.



Designer  
Mario Ruiz

STYLE. ESTILO.  
Singular

## FEATURES. TRAITS. CARACTERÍSTICAS.

---

### Fixed upholstery.

Combined wood and metal frame covered with flexible cold shaped polyurethane foam and polyester fibre.

Seat, back and arms in different polyurethane foam densities, with surface padding in fibre.

Three types of bases to choose from: metal feet with LDPE stops, a cross metal base with LDPE stops, or a flat disc metal base with felt. All metallic elements are coated with manganese coloured polyester powder paint.

### Tapiserie fixe.

Châssis avec combinaison métal et bois recouvert de mousse de polyuréthane souple à froid et de fibre de polyester.

Assise, dossier et accoudoirs réalisés dans différentes densités de mousse polyuréthane, matelassés en surface avec du fibre.

Trois types de bases sont proposés : pieds en métal avec patins en PEBD, base métallique en croix avec patins en PEBD ou base métallique avec socle rond recouvert de feutre. Tous les éléments métalliques sont recouverts de peinture polyester en poudre avec finition manganèse.

### Tapizado fijo.

Bastidor combinado de metal y madera recubierto de espuma de poliuretano flexible en frío y fibra de poliéster.

Asiento, respaldo y brazos realizados en distintas densidades de espuma de poliuretano, acolchado en la superficie con fibra.

Tres tipos de bases a escoger: pies metálicos con topes de LDPE, base metálica en cruz con topes de LDPE o base metálica de disco con fieltro. Todos los elementos metálicos están recubiertos en pintura poliéster en polvo color manganeso.

GREY.

GENERAL MEASUREMENTS. MESURES GÉNÉRALES. MEDIDAS GENERALES.

---

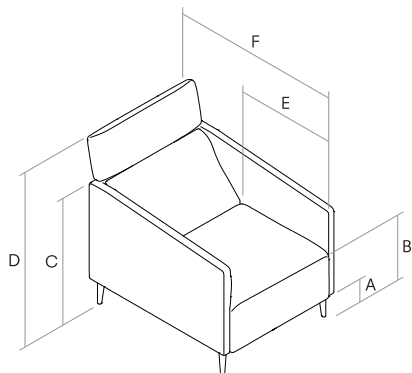

- A. Base height. Hauteur de base. Altura de base. 13 cm - 5.12"
- B. Seat height. Hauteur du siège. Altura de asiento. 41 cm - 16.14"
- C. Arm height. Hauteur du bras. Altura de brazo. 60 cm - 23.62"
- D. Backrest height. Hauteur du dossier. Altura de respaldo. 90 cm - 35.43"
- E. Seat depth. Profondeur d'assise. Profundidad de sentada. 58 cm - 22.83"
- F. Depth. Profondeur. Profundidad. 87 cm - 34.25"

FINISHES. TRAITS. ACABADOS.

---

Finishes for the metal bases. Finitions des pieds métalliques. Acabados de las patas metálicas.

---

Polyester powder paint. Peinture polyester en poudre. Pintura poliéster en polvo.

---



Manganese metal.  
Métal manganèse.  
Metal manganeso.

## GREY.

### PRICES. PRIX. PRECIOS.

#### GREY. Armchairs. Fauteuils. Butacas.



#### GREB70BE

70 x 87 H90  
27.55" x 34.25" H35.43"

Standard metal bases. Bases  
métalliques standard. Bases metálicas  
standard.

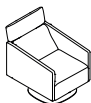

#### GREB70FP

70 x 87 H90  
27.55" x 34.25" H35.43"

Flat metal base, fixed.  
Base métallique avec socle plat, fixe.  
Base metálica plana fija.

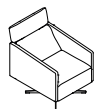

#### GREB70FC

70 x 87 H90  
27.55" x 34.25" H35.43"

Cross-shaped metal base, fixed.  
Base métallique en croix, fixe.  
Base metálica en cruz fija.

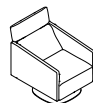

#### GREB70GP

70 x 87 H90  
27.55" x 34.25" H35.43"

Flat metal base rotating with auto-  
return. Base métallique avec socle plat  
pivotante avec retour automatique.  
Base metálica plana giratoria con  
retorno.

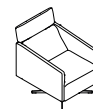

#### GREB70GC

70 x 87 H90  
27.55" x 34.25" H35.43"

Cross-shaped metal base rotating  
with auto-return. Base métallique  
en croix, pivotante avec retour  
automatique. Base metálica en cruz  
giratoria con retorno.

| MEASUREMENT. MESURE. MEDIDA.          | REF.     | M.L. | COM / COL | 1        | 2        | 3        | 4        | 5        | L1       | L2       |
|---------------------------------------|----------|------|-----------|----------|----------|----------|----------|----------|----------|----------|
| 70 x 87 H90   27.55" x 34.25" H35.43" | GREB70BE | 4    | 1.020,66  | 1.066,12 | 1.123,97 | 1.161,16 | 1.256,20 | 1.458,68 | 1.483,47 | 1.661,16 |
| 70 x 87 H90   27.55" x 34.25" H35.43" | GREB70FP | 4    | 1.152,89  | 1.202,48 | 1.247,93 | 1.285,12 | 1.380,17 | 1.553,72 | 1.615,70 | 1.780,99 |
| 70 x 87 H90   27.55" x 34.25" H35.43" | GREB70FC | 4    | 1.152,89  | 1.202,48 | 1.247,93 | 1.285,12 | 1.380,17 | 1.553,72 | 1.615,70 | 1.780,99 |
| 70 x 87 H90   27.55" x 34.25" H35.43" | GREB70GP | 4    | 1.247,93  | 1.285,12 | 1.326,45 | 1.380,17 | 1.483,47 | 1.652,89 | 1.694,21 | 1.863,64 |
| 70 x 87 H90   27.55" x 34.25" H35.43" | GREB70GC | 4    | 1.247,93  | 1.285,12 | 1.326,45 | 1.380,17 | 1.483,47 | 1.652,89 | 1.694,21 | 1.863,64 |

#### GREY. Ottomans. Poufs. Ottomans.



#### GREP65BE

65 x 45 H41  
25.59" x 17.71" H16.14"

Standard metal bases. Bases  
métalliques standard. Bases metálicas  
standard.



#### GREP115BE

115 x 55 H41  
45.27" x 21.65" H16.14"

Standard metal bases. Bases  
métalliques standard. Bases metálicas  
standard.

| MEASUREMENT. MESURE. MEDIDA.           | REF.      | M.L. | COM / COL | 1      | 2      | 3      | 4      | 5      | L1     | L2     |
|--|-----------|------|-----------|--------|--------|--------|--------|--------|--------|--------|
| 65 x 45 H41   25.59" x 17.71" H16.14"  | GREP65BE  | 2    | 466,94    | 479,34 | 487,60 | 495,87 | 528,93 | 590,91 | 599,17 | 644,63 |
| 115 x 55 H41   45.27" x 21.65" H16.14" | GREP115BE | 2    | 528,93    | 537,19 | 582,64 | 599,17 | 644,63 | 756,20 | 776,86 | 871,90 |



# HAT.

# ARMCHAIR. FAUTEUIL. BUTACA.



Designer  
Dario Gagliardini

STYLE. ESTILO.  
Essential

## FEATURES. TRAITS. CARACTERÍSTICAS.

---

Completely removable upholstery. In leather, seat cushion with removable cover.

Wooden frame covered with flexible cold shaped polyurethane foam and polyester fibre.

Suspension consisting of elasticated webbing in different tensions.

Seat cushion, back and arms made in different polyurethane foam densities and surface padding in fibre.

Two types of bases to choose from: a cross metal base with LDPE stops or a flat disc metal base with felt. All metallic elements are coated with manganese coloured polyester powder paint.

Tapiserie entièrement déhoussable. En cuir, coussin de l'assise déhoussable.

Cadre en bois recouvert de mousse de polyuréthane souple à froid et de fibre de polyester.

Suspension au moyen de sangles élastiques entrelacées de différentes tensions.

Coussin, dossier et accoudoirs réalisés dans différentes densités de mousse polyuréthane, matelassés en surface avec du fibre.

Deux types de bases sont proposés : base métallique en croix avec patins en PEBD ou base métallique avec socle rond recouvert de feutre. Tous les éléments métalliques sont recouverts de peinture polyester en poudre couleur manganèse.

Tapicería totalmente desenfundable. En piel, cojín de asiento desenfundable.

Bastidor de madera recubierto de espuma de poliuretano flexible en frío y fibra de poliéster.

Suspensión mediante cinchas elásticas entrelazadas de diferentes tensiones.

Cojín de asiento, respaldo y brazos realizados en distintas densidades de espuma de poliuretano, acolchado en la superficie con fibra.

Dos tipos de bases a escoger: Base metálica en cruz con topes de LDPE o base metálica de disco con fieltro. Todos los elementos metálicos están recubiertos en pintura poliéster en polvo color manganeso.



HAT.

GENERAL MEASUREMENTS. MESURES GÉNÉRALES. MEDIDAS GENERALES.

---

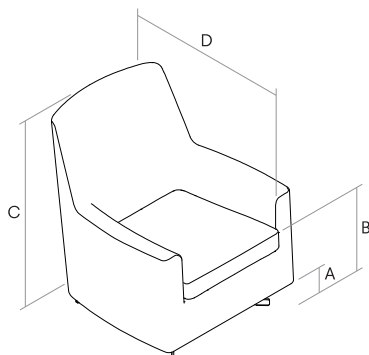

**A.** Base height. Hauteur de base. Altura de base. 10 cm - 3.94"

**B.** Seat height. Hauteur du siège. Altura de asiento. 46 cm - 18.11"

**C.** Backrest height. Hauteur du dossier. Altura de respaldo. 84 cm - 33.07"

**D.** Depth. Profondeur. Profundidad. 88 cm - 34.65"

FINISHES. TRAITS. ACABADOS.

---

Finishes for the metal bases. Finitions des bases métalliques. Acabados de las bases metálicas.

---

Polyester powder paint. Peinture polyester en poudre. Pintura poliéster en polvo.

---



Manganese metal.  
Métal manganèse.  
Metal manganeso.

## HAT.

PRICES. PRIX. PRECIOS.

HAT. Armchairs. Fauteuils. Butacas.



### HATB78FP

78 x 88 H84  
30.70"x 34.64" H33.07"

Flat metal base, fixed.  
Base métallique avec socle plat, fixe.  
Base metálica plana fija.



### HATB78FC

78 x 88 H84  
30.70"x 34.64" H33.07"

Cross-shaped metal base, fixed.  
Base métallique en croix, fixe.  
Base metálica en cruz fija.



### HATB78GP

78 x 88 H84  
30.70"x 34.64" H33.07"

Flat metal base rotating with auto-return. Base métallique avec socle plat pivotante avec retour automatique.  
Base metálica plana giratoria con retorno.



### HATB78GC

78 x 88 H84  
30.70"x 34.64" H33.07"

Cross-shaped metal base rotating with auto-return. Base métallique en croix, pivotante avec retour automatique. Base metálica en cruz giratoria con retorno.

| MEASUREMENT. MESURE. MEDIDA.          | REF.     | M.L. | COM / COL | 1        | 2        | 3        | 4        | 5        | L1       | L2       |
|---------------------------------------|----------|------|-----------|----------|----------|----------|----------|----------|----------|----------|
| 78 x 88 H84   30.70" x 34.64" H33.07" | HATB78FP | 3    | 1.293,39  | 1.326,45 | 1.371,90 | 1.404,96 | 1.491,74 | 1.669,42 | 1.694,21 | 1.834,71 |
| 78 x 88 H84   30.70" x 34.64" H33.07" | HATB78FC | 3    | 1.293,39  | 1.326,45 | 1.371,90 | 1.404,96 | 1.491,74 | 1.669,42 | 1.694,21 | 1.834,71 |
| 78 x 88 H84   30.70" x 34.64" H33.07" | HATB78GP | 3    | 1.363,64  | 1.396,69 | 1.433,88 | 1.491,74 | 1.561,98 | 1.739,67 | 1.772,73 | 1.929,75 |
| 78 x 88 H84   30.70" x 34.64" H33.07" | HATB78GC | 3    | 1.363,64  | 1.396,69 | 1.433,88 | 1.491,74 | 1.561,98 | 1.739,67 | 1.772,73 | 1.929,75 |



# MAGNUS.

# ARMCHAIR. FAUTEUIL. BUTACA.



Designer  
Mario Ruiz

STYLE. ESTILO.  
New Classic

VERSION. VERSIÓN.  
Visible base version. Version base visible. Versión base visible.

## FEATURES. TRAITS. CARACTERÍSTICAS.

---

Completely removable upholstery. In leather, seat and back cushion with removable covers.

Wooden frame covered with flexible cold shaped polyurethane foam and polyester fibre.

Suspension consisting of elasticated webbing in different tensions.

Seat cushion made with polyurethane foam insert, padded with fibre, and washed, sterilised down. Back cushion stuffed with polyester fibre and washed, sterilised down.

Four types of bases to choose from: solid oak feet in a natural finish, U-shaped metal feet with LDPE stops, a cross metal base with LDPE stops, or a metal flat disc base with felt. All metallic elements are coated with manganese coloured polyester powder paint.

Tapiserie entièrement déhoussable. En cuir, coussin de l'assise et coussin du dossier déhoussables.

Cadre en bois recouvert de mousse de polyuréthane souple à froid et de fibre de polyester.

Suspension au moyen de sangles élastiques entrelacées de différentes tensions.

Coussin de l'assise garni de mousse polyuréthane, matelassé avec de la fibre et des plumes lavées et stérilisées. Coussin du dossier garni de fibre de polyester et plumes lavées et stérilisées.

Quatre types de bases sont proposés : pieds en chêne massif finition naturelle, pieds en métal en forme de U avec patins en PEBD, base métallique en croix avec patins en PEBD ou base métallique avec socle rond recouvert de feutre. Tous les éléments métalliques sont recouverts de peinture polyester en poudre couleur manganèse.

Tapicería totalmente desenfundable. En piel, cojín de asiento y respaldo desenfundables.

Bastidor de madera recubierto de espuma de poliuretano flexible en frío y fibra de poliéster.

Suspensión mediante cinchas elásticas entrelazadas de diferentes tensiones.

Cojín de asiento realizado con inserto de espuma de poliuretano, acolchado con fibra y pluma lavada y esterilizada. Cojín de respaldo relleno de fibra de poliéster y pluma lavada y esterilizada.

Cuatro tipos de bases a escoger: pies de roble macizo en acabado natural, pies metálicos en forma de U con topes de LDPE, base metálica en cruz con topes de LDPE o base metálica de disco con fieltro. Todos los elementos metálicos están recubiertos en pintura poliéster en polvo color manganeso.

## MACNUS.

### GENERAL MEASUREMENTS. MESURES GÉNÉRALES. MEDIDAS GENERALES.

---

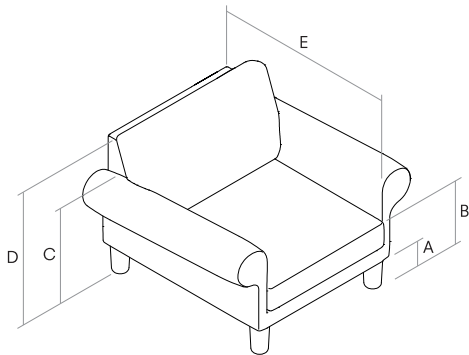

- A. Base height. Hauteur de base. Altura de base. 15 cm - 5.91"
- B. Seat height. Hauteur du siège. Altura de asiento. 40 cm - 15.75"
- C. Arm height. Hauteur du bras. Altura de brazo. 61 cm - 24.02"
- D. Backrest height. Hauteur du dossier. Altura de respaldo. 74 cm - 29.13"
- E. Depth. Profondeur. Profundidad. 73 cm - 28.74"

### FINISHES. TRAITS. ACABADOS.

---

Finishes for the metal bases. Finitions des bases métalliques. Acabados de las bases metálicas.

---

Polyester powder paint. Peinture polyester en poudre. Pintura poliéster en polvo.

---



Manganese metal.  
Métal manganèse.  
Metal manganeso.

Finishes for the wooden feet. Finitions des pieds en bois. Acabados de los pies en madera.

---

Wood finishes. Finitions bois. Acabado de la madera.

---



**RN**  
Natural oak.  
Chêne naturel.  
Roble natural.



**RT**  
Dark stained oak.  
Chêne teint foncée.  
Roble teñido oscuro.



**RL**  
Oak painted in black with open-pore finish.  
Chêne laqué noir à pores ouverts.  
Roble lacado negro por abierto.

## MAGNUS.

PRICES. PRIX. PRECIOS.

MAGNUS. Armchairs. Fauteuils. Butacas.



### MAGB96BE

96 x 83 H81  
37.79" x 32.67" H31.88"

Standard wood bases.  
Bases en bois standard.  
Bases en madera standard.



### MAGB96ME

96 x 83 H81  
37.79" x 32.67" H31.88"

Optional metal bases.  
Bases métalliques en option.  
Bases metálicas opcionales..

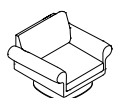

### MAGB96FP

96 x 83 H81  
37.79" x 32.67" H31.88"

Flat metal base, fixed.  
Base métallique avec socle plat, fixe.  
Base metálica plana fija.



### MAGB96FC

96 x 83 H81  
37.79" x 32.67" H31.88"

Cross-shaped metal base, fixed.  
Base métallique en croix, fixe.  
Base metálica en cruz fija.

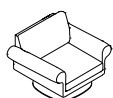

### MAGB96GP

96 x 83 H81  
37.79" x 32.67" H31.88"

Flat metal base rotating with auto-return. Base métallique avec socle plat pivotante avec retour automatique.  
Base metálica plana giratoria con retorno.

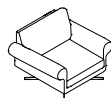

### MAGB96GC

96 x 83 H81  
37.79" x 32.67" H31.88"

Cross-shaped metal base rotating with auto-return. Base métallique en croix, pivotante avec retour automatique. Base metálica en cruz giratoria con retorno.

| MEASUREMENT. MESURE. MEDIDA.          | REF.     | M.L. | COM / COL | 1        | 2        | 3        | 4        | 5        | L1       | L2       |
|---------------------------------------|----------|------|-----------|----------|----------|----------|----------|----------|----------|----------|
| 96 x 83 H81   37.79" x 32.67" H31.88" | MAGB96BE | 6    | 1.628,10  | 1.673,55 | 1.743,80 | 1.805,79 | 1.933,88 | 2.219,01 | 2.280,99 | 2.495,87 |
| 96 x 83 H81   37.79" x 32.67" H31.88" | MAGB96ME | 6    | 1.628,10  | 1.673,55 | 1.743,80 | 1.805,79 | 1.933,88 | 2.219,01 | 2.280,99 | 2.495,87 |
| 96 x 83 H81   37.79" x 32.67" H31.88" | MAGB96FP | 6    | 1.690,08  | 1.752,07 | 1.805,79 | 1.880,17 | 2.004,13 | 2.264,46 | 2.305,79 | 2.541,32 |
| 96 x 83 H81   37.79" x 32.67" H31.88" | MAGB96FC | 6    | 1.690,08  | 1.752,07 | 1.805,79 | 1.880,17 | 2.004,13 | 2.264,46 | 2.305,79 | 2.541,32 |
| 96 x 83 H81   37.79" x 32.67" H31.88" | MAGB96GP | 6    | 1.772,73  | 1.818,18 | 1.896,69 | 1.950,41 | 2.074,38 | 2.342,98 | 2.396,69 | 2.619,83 |
| 96 x 83 H81   37.79" x 32.67" H31.88" | MAGB96GC | 6    | 1.772,73  | 1.818,18 | 1.896,69 | 1.950,41 | 2.074,38 | 2.342,98 | 2.396,69 | 2.619,83 |



# MAGNUS.

# ARMCHAIR. FAUTEUIL. BUTACA.



Designer  
Mario Ruiz

STYLE. ESTILO.  
New Classic

VERSION. VERSIÓN.  
Fabric cover version. Version jupe. Versión faldón.

## FEATURES. TRAITS. CARACTERÍSTICAS.

---

Completely removable upholstery.  
Not available in leather.

Wooden frame covered with flexible cold shaped polyurethane foam and polyester fibre.

Suspension consisting of elasticated webbing in different tensions.

Seat cushion made with polyurethane foam insert, padded with fibre, and washed, sterilised down. Back cushion stuffed with polyester fibre and washed, sterilised down.

Two types of bases to choose from: solid oak feet in a natural finish or a U-shaped metal feet with LDPE stops coated with manganese coloured polyester powder paint.

Tapiserie entièrement déhoussable.  
Non-disponible en cuir.

Cadre en bois recouvert de mousse de polyuréthane souple à froid et de fibre de polyester.

Suspension au moyen de sangles élastiques entrelacées de différentes tensions.

Coussin de l'assise garni de mousse polyuréthane, matelassé avec de la fibre et des plumes lavées et stérilisées. Coussin du dossier garni de fibre de polyester et plumes lavées et stérilisées.

Deux types de bases sont proposés : pieds en chêne massif finition naturelle ou pieds en métal en forme de U avec patins en PEBD, recouverts de peinture polyester en poudre couleur manganèse.

Tapicería totalmente desenfundable.  
No disponible en piel.

Bastidor de madera recubierto de espuma de poliuretano flexible en frío y fibra de poliéster.

Suspensión mediante cinchas elásticas entrelazadas de diferentes tensiones.

Cojín de asiento realizado con inserto de espuma de poliuretano, acolchado con fibra y pluma lavada y esterilizada. Cojín de respaldo relleno de fibra de poliéster y pluma lavada y esterilizada.

Dos tipos de bases a escoger: pies de roble macizo en acabado natural y pies metálicos recubiertos en pintura poliéster en polvo color manganeso, en forma de U con topes de LDPE.



## MACNUS.

### GENERAL MEASUREMENTS. MESURES GÉNÉRALES. MEDIDAS GENERALES.

---

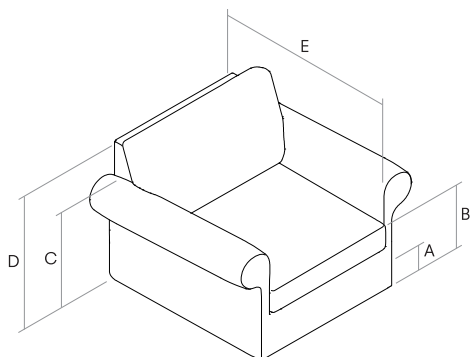

- A. Base height. Hauteur de base. Altura de base. 15 cm - 5.91"
- B. Seat height. Hauteur du siège. Altura de asiento. 40 cm - 15.75"
- C. Arm height. Hauteur des bras. Altura de brazo. 61 cm - 24.02"
- D. Backrest height. Hauteur du dossier. Altura de respaldo. 74 cm - 29.13"
- E. Depth. Profondeur. Profundidad. 73 cm - 28.74"

### FINISHES. TRAITS. ACABADOS.

---

Finishes for the metal bases. Finitions des bases métalliques. Acabados de las bases metálicas.

---

Polyester powder paint. Peinture polyester en poudre. Pintura poliéster en polvo.

---



Manganese metal.  
Métal manganèse.  
Metal manganeso.

Finishes for the wooden feet. Finitions des pieds en bois. Acabados de los pies en madera.

---

Wood finishes. Finitions bois. Acabado de la madera.

---



Natural oak.  
Chêne naturel.  
Roble natural.

## MAGNUS.

PRICES. PRIX. PRECIOS.

---

MAGNUS. Armchairs. Fauteuils. Butacas.

---

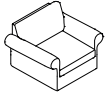

### MAGB96FABE

96 x 83 H81  
37.79" x 32.67" H31.88"

Standard wood bases.  
Bases en bois standard.  
Bases en madera standard.

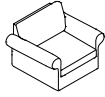

### MAGB96FAME

96 x 83 H81  
37.79" x 32.67" H31.88"

Optional metal bases.  
Bases métalliques en option.  
Bases metálicas opcionales..

| MEASUREMENT. MESURE. MEDIDA.         | REF.       | M.L. | COM / COL | 1        | 2        | 3        | 4        | 5        |
|--------------------------------------|------------|------|-----------|----------|----------|----------|----------|----------|
| 96 x 83 H81   37.79" x 32.67" H31.88 | MAGB96FABE | 6.5  | 1.690,08  | 1.752,07 | 1.851,24 | 1.913,22 | 2.020,66 | 2.318,18 |
| 96 x 83 H81   37.79" x 32.67" H31.88 | MAGB96FAME | 6.5  | 1.690,08  | 1.752,07 | 1.851,24 | 1.913,22 | 2.020,66 | 2.318,18 |





Designer  
Mario Ruiz

STYLE. ESTILO.  
Singular

## FEATURES. TRAITS. CARACTERÍSTICAS.

Removable upholstery in seat and back cushions.

Wooden frame covered with flexible cold shaped polyurethane foam and polyester fibre.

Seat cushion in different polyurethane foam densities, with surface padding in fibre. Back cushion stuffed with polyester fibre and washed, sterilised down.

### REMOVABLE COVER VERSION FEATURES.

Completely removable upholstery. In leather, seat and back cushions with removable covers.

Wooden frame covered with flexible cold shaped polyurethane foam and polyester fibre.

Seat cushion in different polyurethane foam densities, with surface padding in fibre. Back cushion stuffed with polyester fibre and washed, sterilised down.

Three types of bases to choose from: metal feet with LDPE stops, a cross metal base with LDPE stops, or a flat disc metal base with felt. All metallic elements are coated with manganese coloured polyester powder paint.

Tapiserie déhoussable sur le coussin de l'assise et coussin du dossier.

Cadre en bois recouvert de mousse de polyuréthane souple à froid et de fibre de polyester.

Coussin de l'assise réalisé dans différentes densités de mousse polyuréthane, matelassé en surface avec du fibre. Coussin du dossier garni de fibre de polyester et plumes lavées et stérilisées.

### TRAITS VERSION DÉHOUSSABLE

Tapiserie entièrement déhoussable. En cuir, coussin de l'assise et du dossier déhoussables.

Cadre en bois recouvert de mousse de polyuréthane souple à froid et de fibre de polyester.

Coussin de l'assise réalisé dans différentes densités de mousse polyuréthane, matelassé en surface avec du fibre. Coussin du dossier garni de fibre de polyester et plumes lavées et stérilisées.

Trois types de bases sont proposés : pieds en métal avec patins en PEBD, base métallique en croix avec patins en PEBD ou base métallique avec socle rond recouvert de feutre. Tous les éléments métalliques sont recouverts de peinture polyester en poudre avec finition manganèse.

Tapicería desenfundable en cojín de asiento y cojín de respaldo.

Bastidor de madera recubierto de espuma de poliuretano flexible en frío y fibra de poliéster.

Cojín de asiento realizado en distintas densidades de espuma de poliuretano, acolchado en la superficie con fibra. Cojín de respaldo relleno de fibra de poliéster y pluma lavada y esterilizada.

### CARACTERÍSTICAS VERSIÓN DESENFUNDABLE

Tapicería totalmente desenfundable. En piel, cojines de asiento y respaldo desenfundables.

Bastidor de madera recubierto de espuma de poliuretano flexible en frío y fibra de poliéster.

Cojín de asiento realizado en distintas densidades de espuma de poliuretano, acolchado en la superficie con fibra. Cojín de respaldo relleno de fibra de poliéster y pluma lavada y esterilizada.

Tres tipos de bases a escoger: pies metálicos con topes de LDPE, base metálica en cruz con topes de LDPE o base metálica de disco con fieltro. Todos los elementos metálicos están recubiertos en pintura poliéster en polvo color manganeso.

## SENSO.

### GENERAL MEASUREMENTS. MESURES GÉNÉRALES. MEDIDAS GENERALES.

---

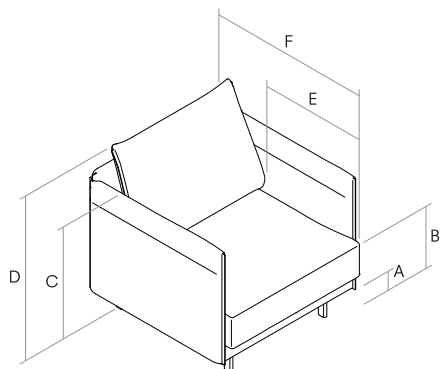

- A. Base height. Hauteur de base. Altura de base. 10 cm - 3.94"
- B. Seat height. Hauteur du siège. Altura de asiento. 42 cm - 16.54"
- C. Arm height. Hauteur des bras. Altura de brazo. 55 cm - 21.65"
- D. Backrest height. Hauteur du dossier. Altura de respaldo. 83 cm - 32.68"
- E. Seat depth. Profondeur d'assise. Profundidad de asiento. 52 cm - 20.47"
- F. Depth. Profondeur. Profundidad. 81 cm - 31.89"

### FINISHES. TRAITS. ACABADOS.

---

Finishes for the metal bases. Finitions des bases métalliques. Acabados de las bases metálicas.

---

Polyester powder paint. Peinture polyester en poudre. Pintura poliéster en polvo.

---



Manganese metal.  
Métal manganèse.  
Metal manganeso.

SENSO.

PRICES. PRIX. PRECIOS.

SENSO. Armchairs. Fauteuils. Butacas.



**SENB80BE**

80 x 81 H83  
31.49" x 31.88" H32.67"

Standard metal bases. Bases  
métalliques standard. Bases metálicas  
standard



**SENB80FP**

80 x 81 H83  
31.49" x 31.88" H32.67"

Flat metal base, fixed.  
Base métallique avec socle plat, fixe.  
Base metálica plana fija.



**SENB80FC**

80 x 81 H83  
31.49" x 31.88" H32.67"

Cross-shaped metal base, fixed.  
Base métallique en croix, fixe.  
Base metálica en cruz fija.



**SENB80GP**

80 x 81 H83  
31.49" x 31.88" H32.67"

Flat metal base rotating with auto-  
return. Base métallique avec socle plat  
pivotante avec retour automatique.  
Base metálica plana giratoria con  
retorno.



**SENB80GC**

80 x 81 H83  
31.49" x 31.88" H32.67"

Cross-shaped metal base rotating  
with auto-return. Base métallique  
en croix, pivotante avec retour  
automatique. Base metálica en cruz  
giratoria con retorno.

| MEASUREMENT. MESURE. MEDIDA.          | REF.     | M.L. | COM / COL | 1        | 2        | 3        | 4        | 5        | L1       | L2       |
|---------------------------------------|----------|------|-----------|----------|----------|----------|----------|----------|----------|----------|
| 80 x 81 H83   31.49" x 31.88" H32.67" | SENB80BE | 5    | 1.342,98  | 1.396,69 | 1.442,15 | 1.504,13 | 1.632,23 | 1.764,46 | 1.793,39 | 1.958,68 |
| 80 x 81 H83   31.49" x 31.88" H32.67" | SENB80FP | 5    | 1.425,62  | 1.483,47 | 1.520,66 | 1.590,91 | 1.677,69 | 1.826,45 | 1.842,98 | 2.000,00 |
| 80 x 81 H83   31.49" x 31.88" H32.67" | SENB80FC | 5    | 1.425,62  | 1.483,47 | 1.520,66 | 1.590,91 | 1.677,69 | 1.826,45 | 1.842,98 | 2.000,00 |
| 80 x 81 H83   31.49" x 31.88" H32.67" | SENB80GP | 5    | 1.491,74  | 1.528,93 | 1.607,44 | 1.652,89 | 1.764,46 | 1.888,43 | 1.929,75 | 2.090,91 |
| 80 x 81 H83   31.49" x 31.88" H32.67" | SENB80GC | 5    | 1.491,74  | 1.528,93 | 1.607,44 | 1.652,89 | 1.764,46 | 1.888,43 | 1.929,75 | 2.090,91 |



# SERENE.

# ARMCHAIR. FAUTEUIL. BUTACA.



Designer  
Mario Ruiz

STYLE. ESTILO.  
Singular

VERSION. VERSIÓN.  
Suspended base. Base suspendue. Base suspendida.  
High arm. Accoudoir haut. Brazo alto.

## FEATURES. TRAITS. CARACTERÍSTICAS.

---

Removable upholstery in seat and back.

Wooden frame covered with flexible cold shaped polyurethane foam and polyester fibre.

Suspension consisting of fibreglass reinforced plastic slats.

Seat cushion in different polyurethane foam densities, with surface padding in fibre. Back cushion stuffed with polyester fibre and washed, sterilised down.

Two types of bases to choose from: a cross metal base with LDPE stops or a flat disc metal base with felt. All metallic elements are coated with manganese coloured polyester powder paint.

Tapiserie déhoussable sur le coussin de l'assise et du dossier.

Cadre en bois recouvert de mousse de polyuréthane souple à froid et de fibre de polyester.

Suspension au moyen de lattes renforcées avec de la fibre de verre.

Coussin de l'assise réalisé dans différentes densités de mousse polyuréthane, matelassé en surface avec du fibre. Coussin du dossier garni de fibre de polyester et plumes lavées et stérilisées.

Deux types de bases sont proposés: base métallique en croix avec patins en PEBD ou base métallique avec socle rond recouvert de feutre. Tous les éléments métalliques sont recouverts de peinture polyester en poudre couleur manganèse.

Tapicería desenfundable en cojín de asiento y cojín de respaldo.

Wooden frame covered with flexible cold shaped polyurethane foam and polyester fibre.

Suspensión mediante lamas de plástico reforzadas con fibra de vidrio.

Cojín de asiento realizado en distintas densidades de espuma de poliuretano, acolchado en la superficie con fibra. Cojín de respaldo relleno de fibra de poliéster y pluma lavada y esterilizada.

Dos tipos de bases a escoger: Base metálica en cruz con topes de LDPE o base metálica de disco con fieltro. Todos los elementos metálicos están recubiertos en pintura poliéster en polvo color manganeso.



## SERENE.

### GENERAL MEASUREMENTS. MESURES GÉNÉRALES. MEDIDAS GENERALES.

---

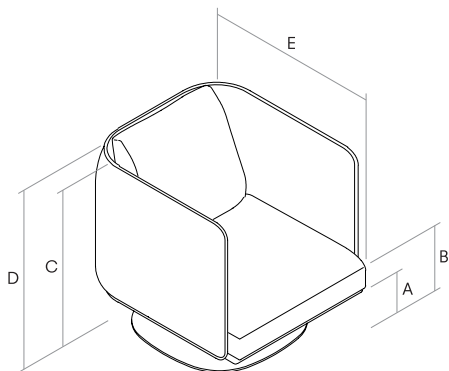

- A. Base height. Hauteur de base. Altura de base. 13 cm - 5.12"
- B. Seat height. Hauteur du siège. Altura de asiento. 40 cm - 15.75"
- C. Arm height. Hauteur du bras. Altura de brazo. 78 cm - 30.71"
- D. Backrest height. Hauteur du dossier. Altura de respaldo. 81 cm - 31.89"
- E. Depth. Profondeur. Profundidad. 82 cm - 32.28"

### FINISHES. TRAITS. ACABADOS.

---

Finishes for the metal bases. Finitions des bases métalliques. Acabados de las bases metálicas.

---

Polyester powder paint. Peinture polyester en poudre. Pintura poliéster en polvo.

---



Manganese metal.  
Métal manganèse.  
Metal manganeso.

## SERENE.

PRICES. PRIX. PRECIOS.

SERENE. Armchairs. Fauteuils. Butacas.



### SERB74BSBAFP

74 x 82 H81  
29.13" x 32.28" H31.88"

Flat metal base, fixed. Suspended base. High arm. Base métallique avec socle plat, fixe. Base suspendue. Bras haut. Base metálica plana fija. Base suspendida. Brazo alto.



### SERB74BSBAFC

74 x 82 H81  
29.13" x 32.28" H31.88"

Cross-shaped metal base, fixed. Suspended base. High arm. Base métallique en croix, fixe. Base suspendue. Bras haut. Base metálica en cruz fija. Base suspendida. Brazo alto.



### SERB74BSBAGP

74 x 82 H81  
29.13" x 32.28" H31.88"

Flat metal base rotating with auto-return. Suspended base. High arm. Base métallique avec socle plat pivotante avec retour automatique. Base suspendue. Bras haut. Base metálica plana giratoria con retorno. Base suspendida. Brazo alto.



### SERB74BSBAGC

74 x 82 H81  
29.13" x 32.28" H31.88"

Cross-shaped metal base rotating with auto-return. Suspended base. High arm. Base métallique en croix, pivotante avec retour automatique. Base suspendue. Bras haut. Base metálica en cruz giratoria con retorno. Base suspendida. Brazo alto.



### SERB90BSBAFP

90 x 87 H81  
35.43" x 34.25" H31.88"

Flat metal base, fixed. Suspended base. High arm. Base métallique avec socle plat, fixe. Base suspendue. Bras haut. Base metálica plana fija. Base suspendida. Brazo alto.



### SERB90BSBAFC

90 x 87 H81  
35.43" x 34.25" H31.88"

Cross-shaped metal base, fixed. Suspended base. High arm. Base métallique en croix, fixe. Base suspendue. Bras haut. Base metálica en cruz fija. Base suspendida. Brazo alto.



### SERB90BSBAGP

90 x 87 H81  
35.43" x 34.25" H31.88"

Flat metal base rotating with auto-return. Suspended base. High arm. Base métallique avec socle plat pivotante avec retour automatique. Base suspendue. Bras haut. Base metálica plana giratoria con retorno. Base suspendida. Brazo alto.



### SERB90BSBAGC

90 x 87 H81  
35.43" x 34.25" H31.88"

Cross-shaped metal base rotating with auto-return. Suspended base. High arm. Base métallique en croix, pivotante avec retour automatique. Base suspendue. Bras haut. Base metálica en cruz giratoria con retorno. Base suspendida. Brazo alto.

| MEASUREMENT. MESURE. MEDIDA.          | REF.         | M.L. | COM / COL | 1        | 2        | 3        | 4        | 5        | L1       | L2       |
|---------------------------------------|--------------|------|-----------|----------|----------|----------|----------|----------|----------|----------|
| 74 x 82 H81   29.13" x 32.28" H31.88" | SERB74BSBAFP | 4.5  | 1.396,69  | 1.433,88 | 1.504,13 | 1.545,45 | 1.677,69 | 1.888,43 | 1.942,15 | 2.169,42 |
| 74 x 82 H81   29.13" x 32.28" H31.88" | SERB74BSBAFC | 4.5  | 1.396,69  | 1.433,88 | 1.504,13 | 1.545,45 | 1.677,69 | 1.888,43 | 1.942,15 | 2.169,42 |
| 74 x 82 H81   29.13" x 32.28" H31.88" | SERB74BSBAGP | 4.5  | 1.512,40  | 1.528,93 | 1.607,44 | 1.652,89 | 1.772,73 | 1.983,47 | 2.028,93 | 2.247,93 |
| 74 x 82 H81   29.13" x 32.28" H31.88" | SERB74BSBAGC | 4.5  | 1.512,40  | 1.528,93 | 1.607,44 | 1.652,89 | 1.772,73 | 1.983,47 | 2.028,93 | 2.247,93 |
| 90 x 87 H81   35.43" x 34.25" H31.88" | SERB90BSBAFP | 5    | 1.582,64  | 1.623,97 | 1.702,48 | 1.772,73 | 1.913,22 | 2.210,74 | 2.256,20 | 2.528,93 |
| 90 x 87 H81   35.43" x 34.25" H31.88" | SERB90BSBAFC | 5    | 1.582,64  | 1.623,97 | 1.702,48 | 1.772,73 | 1.913,22 | 2.210,74 | 2.256,20 | 2.528,93 |
| 90 x 87 H81   35.43" x 34.25" H31.88" | SERB90BSBAGP | 5    | 1.677,69  | 1.723,14 | 1.793,39 | 1.871,90 | 2.020,66 | 2.289,26 | 2.342,98 | 2.607,44 |
| 90 x 87 H81   35.43" x 34.25" H31.88" | SERB90BSBAGP | 5    | 1.677,69  | 1.723,14 | 1.793,39 | 1.871,90 | 2.020,66 | 2.289,26 | 2.342,98 | 2.607,44 |



# SERENE.

# ARMCHAIR. FAUTEUIL. BUTACA.



Designer  
Mario Ruiz

STYLE. ESTILO.  
Singular

VERSION. VERSIÓN.  
Suspended base. Base suspendue. Base suspendida.  
Low arm. Accoudoir bas. Brazo bajo.

## FEATURES. TRAITS. CARACTERÍSTICAS.

---

Removable upholstery in seat and back.

Wooden frame covered with flexible cold shaped polyurethane foam and polyester fibre.

Suspension consisting of fibreglass reinforced plastic slats.

Seat cushion in different polyurethane foam densities, with surface padding in fibre. Back cushion stuffed with polyester fibre and washed, sterilised down.

Two types of bases to choose from: a cross metal base with LDPE stops or a flat disc metal base with felt. All metallic elements are coated with manganese coloured polyester powder paint.

Tapiserie déhoussable sur le coussin de l'assise et du dossier.

Cadre en bois recouvert de mousse de polyuréthane souple à froid et de fibre de polyester.

Suspension au moyen de lattes renforcées avec de la fibre de verre.

Coussin de l'assise réalisé dans différentes densités de mousse polyuréthane, matelassé en surface avec du fibre. Coussin du dossier garni de fibre de polyester et plumes lavées et stérilisées.

Deux types de bases sont proposés : base métallique en croix avec patins en PEBD ou base métallique avec socle rond recouvert de feutre. Tous les éléments métalliques sont recouverts de peinture polyester en poudre couleur manganèse.

Tapicería desenfundable en cojín de asiento y cojín de respaldo.

Wooden frame covered with flexible cold shaped polyurethane foam and polyester fibre.

Suspensión mediante lamas de plástico reforzadas con fibra de vidrio.

Cojín de asiento realizado en distintas densidades de espuma de poliuretano, acolchado en la superficie con fibra. Cojín de respaldo relleno de fibra de poliéster y pluma lavada y esterilizada.

Dos tipos de bases a escoger: Base metálica en cruz con topes de LDPE o base metálica de disco con fieltro. Todos los elementos metálicos están recubiertos en pintura poliéster en polvo color manganeso.

## SERENE.

### GENERAL MEASUREMENTS. MESURES GÉNÉRALES. MEDIDAS GENERALES.

---

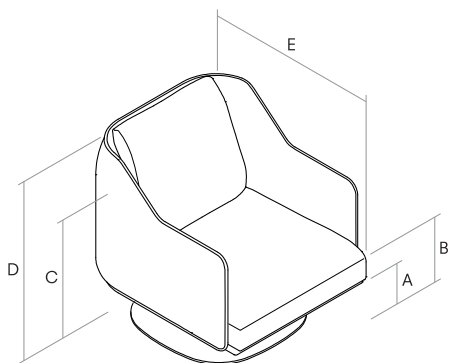

- A. Base height. Baseur de base. Altura de base. 13 cm - 5.12"
- B. Seat height. Baseur du siège. Altura de asiento. 40 cm - 15.75"
- C. Arm height. Baseur du bras. Altura de brazo. 56 cm - 22.05"
- D. Backrest height. Hauteur du dossier. Altura de respaldo. 81 cm - 31.89"
- E. Depth. Profondeur. Profundidad. 82 cm - 32.28"

### FINISHES. TRAITS. ACABADOS.

---

Finishes for the metal bases. Finitions des bases métalliques. Acabados de las bases metálicas.

---

Polyester powder paint. Peinture polyester en poudre. Pintura poliéster en polvo.

---



Manganese metal.  
Métal manganèse.  
Metal manganeso.

## SERENE.

PRICES. PRIX. PRECIOS.

SERENE. Armchairs. Fauteuils. Butacas.



### SERB74BSBBFP

74 x 82 H81  
29.13" x 32.28" H31.88"

Flat metal base, fixed. Suspended base. Low arm. Base métallique avec socle plat, fixe. Base suspendue. Bras bas. Base metálica plana fija. Base suspendida. Brazo bajo.



### SERB74BSBBFC

74 x 82 H81  
29.13" x 32.28" H31.88"

Cross-shaped metal base, fixed. Suspended base. Low arm. Base métallique en croix, fixe. Base suspendue. Bras bas. Base metálica en cruz fija. Base suspendida. Brazo bajo.



### SERB74BSBBGP

74 x 82 H81  
29.13" x 32.28" H31.88"

Flat metal base rotating with auto-return. Suspended base. Low arm. Base métallique avec socle plat pivotante avec retour automatique. Base suspendue. Bras bas. Base metálica plana giratoria con retorno. Base suspendida. Brazo bajo.



### SERB74BSBBGC

74 x 82 H81  
29.13" x 32.28" H31.88"

Cross-shaped metal base rotating with auto-return. Suspended base. Low arm. Base métallique en croix, pivotante avec retour automatique. Base suspendue. Bras bas. Base metálica en cruz giratoria con retorno. Base suspendida. Brazo bajo.



### SERB90BSBBFP

90 x 87 H81  
35.43" x 34.25" H31.88"

Flat metal base, fixed. Suspended base. Low arm. Base métallique avec socle plat, fixe. Base suspendue. Bras bas. Base metálica plana fija. Base suspendida. Brazo bajo.



### SERB90BSBBFC

90 x 87 H81  
35.43" x 34.25" H31.88"

Cross-shaped metal base, fixed. Suspended base. Low arm. Base métallique en croix, fixe. Base suspendue. Bras bas. Base metálica en cruz fija. Base suspendida. Brazo bajo.



### SERB90BSBBGP

90 x 87 H81  
35.43" x 34.25" H31.88"

Flat metal base rotating with auto-return. Suspended base. Low arm. Base métallique avec socle plat pivotante avec retour automatique. Base suspendue. Bras bas. Base metálica plana giratoria con retorno. Base suspendida. Brazo bajo.



### SERB90BSBBGC

90 x 87 H81  
35.43" x 34.25" H31.88"

Cross-shaped metal base rotating with auto-return. Suspended base. Low arm. Base métallique en croix, pivotante avec retour automatique. Base suspendue. Bras bas. Base metálica en cruz giratoria con retorno. Base suspendida. Brazo bajo.

| MEASUREMENT. MESURE. MEDIDA.          | REF.         | M.L. | COM / COL | 1        | 2        | 3        | 4        | 5        | L1       | L2       |
|---------------------------------------|--------------|------|-----------|----------|----------|----------|----------|----------|----------|----------|
| 74 x 82 H81   29.13" x 32.28" H31.88" | SERB74BSBAFP | 4.5  | 1.396,69  | 1.433,88 | 1.504,13 | 1.545,45 | 1.677,69 | 1.888,43 | 1.942,15 | 2.169,42 |
| 74 x 82 H81   29.13" x 32.28" H31.88" | SERB74BSBAFC | 4.5  | 1.396,69  | 1.433,88 | 1.504,13 | 1.545,45 | 1.677,69 | 1.888,43 | 1.942,15 | 2.169,42 |
| 74 x 82 H81   29.13" x 32.28" H31.88" | SERB74BSBAGP | 4.5  | 1.512,40  | 1.528,93 | 1.607,44 | 1.652,89 | 1.772,73 | 1.983,47 | 2.028,93 | 2.247,93 |
| 74 x 82 H81   29.13" x 32.28" H31.88" | SERB74BSBAGC | 4.5  | 1.512,40  | 1.528,93 | 1.607,44 | 1.652,89 | 1.772,73 | 1.983,47 | 2.028,93 | 2.247,93 |
| 90 x 87 H81   35.43" x 34.25" H31.88" | SERB90BSBAFP | 5    | 1.582,64  | 1.623,97 | 1.702,48 | 1.772,73 | 1.913,22 | 2.210,74 | 2.256,20 | 2.528,93 |
| 90 x 87 H81   35.43" x 34.25" H31.88" | SERB90BSBAFC | 5    | 1.582,64  | 1.623,97 | 1.702,48 | 1.772,73 | 1.913,22 | 2.210,74 | 2.256,20 | 2.528,93 |
| 90 x 87 H81   35.43" x 34.25" H31.88" | SERB90BSBAGP | 5    | 1.677,69  | 1.723,14 | 1.793,39 | 1.871,90 | 2.020,66 | 2.289,26 | 2.342,98 | 2.607,44 |
| 90 x 87 H81   35.43" x 34.25" H31.88" | SERB90BSBAGP | 5    | 1.677,69  | 1.723,14 | 1.793,39 | 1.871,90 | 2.020,66 | 2.289,26 | 2.342,98 | 2.607,44 |



# SERENE.

# ARMCHAIR. FAUTEUIL. BUTACA.



Designer  
Mario Ruiz

STYLE. ESTILO.  
Singular

VERSION. VERSIÓN.  
Floor standing. Ras du sol. Base a suelo.  
High arm. Accoudoir haut. Brazo alto.

## FEATURES. TRAITS. CARACTERÍSTICAS.

---

Removable upholstery in back cushion.

Wooden frame covered with flexible cold shaped polyurethane foam and polyester fibre.

Suspension consisting of fibreglass reinforced plastic slats.

Seat in different polyurethane foam densities, with surface padding in fibre. Back cushion stuffed with polyester fibre and washed, sterilised down.

Two types of bases to choose from: LDPE bases or a flat disc metal base with felt, coated with manganese coloured polyester powder paint.

Tapiserie déhoussable sur le coussin du dossier.

Cadre en bois recouvert de mousse de polyuréthane souple à froid et de fibre de polyester.

Suspension au moyen de lattes renforcées avec de la fibre de verre.

Assise réalisé dans différentes densités de mousse polyuréthane, matelassé en surface avec du fibre. Coussin du dossier garni de fibre de polyester et plumes lavées et stérilisées.

Deux types de bases sont proposés: Pieds en PEBD ou base métallique avec socle rond recouvert de feutre, recouverts de peinture polyester en poudre couleur manganèse.

Tapicería desenfundable en cojín de respaldo.

Bastidor de madera recubierto de espuma de poliuretano flexible en frío y fibra de poliéster.

Suspensión mediante lamas de plástico reforzadas con fibra de vidrio.

Asiento realizado en distintas densidades de espuma de poliuretano, acolchado en la superficie con fibra. Cojín de respaldo relleno de fibra de poliéster y pluma lavada y esterilizada.

Dos tipos de bases a escoger: Bases fabricadas en LDPE con protectores de fieltro o base metálica de disco con fieltro recubierta en pintura poliéster en polvo color manganeso.



## SERENE.

### GENERAL MEASUREMENTS. MESURES GÉNÉRALES. MEDIDAS GENERALES.

---

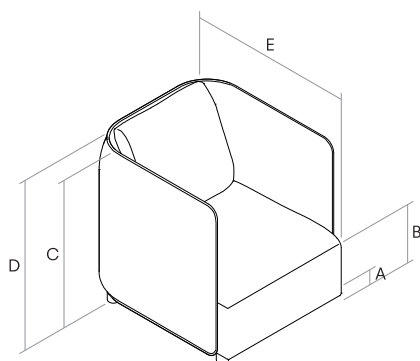

- A. Base height. Hauteur de base. Altura de base. 5 cm - 1.97"
- B. Seat height. Hauteur du siège. Altura de asiento. 40 cm - 15.75"
- C. Arm height. Hauteur du bras. Altura de brazo. 78 cm - 30.71"
- D. Backrest height. Hauteur du dossier. Altura de respaldo. 81 cm - 31.89"
- E. Depth. Profondeur. Profundidad. 82 cm - 32.28"

### FINISHES. TRAITS. ACABADOS.

---

Finishes for the metal bases. Finitions des bases métalliques. Acabados de las bases metálicas.

---

Polyester powder paint. Peinture polyester en poudre. Pintura poliéster en polvo.

---



Manganese metal.  
Métal manganèse.  
Metal manganeso.

Finishes for the feet. Finitions des pieds. Acabados de las patas.

---

Low density polyethylene. Polyéthylène basse densité. Polietileno de baja densidad.

---



LDPE  
PEBD

## SERENE.

PRICES. PRIX. PRECIOS.

SERENE. Armchairs. Fauteuils. Butacas.



### SERB74BTBABA

74 x 82 H81  
29.13" x 32.28" H31.88"

Standard LDPE bases. Upholstered base. High arm. Bases PEED standard. Base tapissée. Bras haut. Bases LDPE standard. Base tapizada. Brazo alto.



### SERB74BTBAFP

74 x 82 H81  
29.13" x 32.28" H31.88"

Flat metal base, fixed. Upholstered base. High arm. Base métallique avec socle plat, fixe. Base tapissée. Bras haut. Base metálica plana fija. Base tapizada. Brazo alto.



### SERB74BTBAGP

74 x 82 H81  
29.13" x 32.28" H31.88"

Flat metal base rotating with auto-return. Upholstered base. High arm. Base métallique avec socle plat pivotante avec retour automatique. Base tapissée. Bras haut. Base metálica plana giratoria con retorno. Base tapizada. Brazo alto.



### SERB90BTBABA

90 x 87 H81  
35.43" x 34.25" H31.88"

Standard LDPE bases. Upholstered base. High arm. Bases PEED standard. Base tapissée. Bras haut. Bases LDPE standard. Base tapizada. Brazo alto.



### SERB90BTBAFP

90 x 87 H81  
35.43" x 34.25" H31.88"

Flat metal base, fixed. Upholstered base. High arm. Base métallique avec socle plat, fixe. Base tapissée. Bras haut. Base metálica plana fija. Base tapizada. Brazo alto.



### SERB90BTBAGP

90 x 87 H81  
35.43" x 34.25" H31.88"

Flat metal base rotating with auto-return. Upholstered base. High arm. Base métallique avec socle plat pivotante avec retour automatique. Base tapissée. Bras haut. Base metálica plana giratoria con retorno. Base tapizada. Brazo alto.

| MEASUREMENT. MESURE. MEDIDA.          | REF.         | M.L. | COM / COL | 1        | 2        | 3        | 4        | 5        | L1       | L2       |
|---------------------------------------|--------------|------|-----------|----------|----------|----------|----------|----------|----------|----------|
| 74 x 82 H81   29.13" x 32.28" H31.88" | SERB74BTBABA | 5    | 1.177,69  | 1.231,40 | 1.285,12 | 1.355,37 | 1.483,47 | 1.723,14 | 1.772,73 | 2.012,40 |
| 74 x 82 H81   29.13" x 32.28" H31.88" | SERB74BTBAFP | 5    | 1.537,19  | 1.590,91 | 1.652,89 | 1.723,14 | 1.842,98 | 2.082,64 | 2.132,23 | 2.380,17 |
| 74 x 82 H81   29.13" x 32.28" H31.88" | SERB74BTBAGP | 5    | 1.537,19  | 1.590,91 | 1.652,89 | 1.723,14 | 1.842,98 | 2.082,64 | 2.132,23 | 2.380,17 |
| 90 x 87 H81   35.43" x 34.25" H31.88" | SERB90BTBABA | 5.5  | 1.371,90  | 1.404,96 | 1.491,74 | 1.561,98 | 1.731,40 | 2.028,93 | 2.082,64 | 2.380,17 |
| 90 x 87 H81   35.43" x 34.25" H31.88" | SERB90BTBAFP | 5.5  | 1.731,40  | 1.772,73 | 1.851,24 | 1.942,15 | 2.099,17 | 2.380,17 | 2.450,41 | 2.735,54 |
| 90 x 87 H81   35.43" x 34.25" H31.88" | SERB90BTBAGP | 5.5  | 1.731,40  | 1.772,73 | 1.851,24 | 1.942,15 | 2.099,17 | 2.380,17 | 2.450,41 | 2.735,54 |



# SERENE.

# ARMCHAIR. FAUTEUIL. BUTACA.



Designer  
Mario Ruiz

STYLE. ESTILO.  
Singular

VERSION. VERSIÓN.  
Floor standing. Ras du sol. Base a suelo.  
Low arm. Accoudoir bas. Brazo bajo.

## FEATURES. TRAITS. CARACTERÍSTICAS.

---

Removable upholstery in back cushion.

Wooden frame covered with flexible cold shaped polyurethane foam and polyester fibre.

Suspension consisting of fibreglass reinforced plastic slats.

Seat in different polyurethane foam densities, with surface padding in fibre. Back cushion stuffed with polyester fibre and washed, sterilised down.

Two types of bases to choose from: LDPE bases or a flat disc metal base with felt, coated with manganese coloured polyester powder paint.

Tapiserie déhoussable sur le coussin du dossier.

Cadre en bois recouvert de mousse de polyuréthane souple à froid et de fibre de polyester.

Suspension au moyen de lattes renforcées avec de la fibre de verre.

Assise réalisé dans différentes densités de mousse polyuréthane, matelassé en surface avec du fibre. Coussin du dossier garni de fibre de polyester et plumes lavées et stérilisées.

Deux types de bases sont proposés: Pieds en PEBD ou base métallique avec socle rond recouvert de feutre, recouverts de peinture polyester en poudre couleur manganèse.

Tapicería desenfundable en cojín de respaldo.

Bastidor de madera recubierto de espuma de poliuretano flexible en frío y fibra de poliéster.

Suspensión mediante lamas de plástico reforzadas con fibra de vidrio.

Asiento realizado en distintas densidades de espuma de poliuretano, acolchado en la superficie con fibra. Cojín de respaldo relleno de fibra de poliéster y pluma lavada y esterilizada.

Dos tipos de bases a escoger: Bases fabricadas en LDPE con protectores de fieltro o base metálica de disco con fieltro recubierta en pintura poliéster en polvo color manganeso.

## SERENE.

### GENERAL MEASUREMENTS. MESURES GÉNÉRALES. MEDIDAS GENERALES.

---

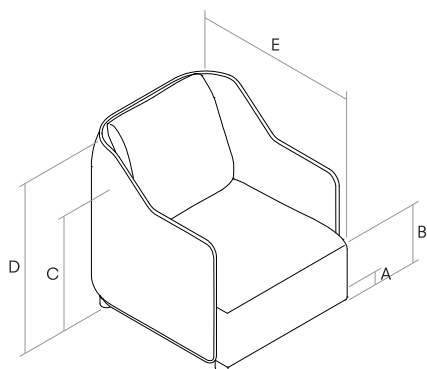

- A. Base height. Hauteur de base. Altura de base. 5 cm - 1.97"
- B. Seat height. Hauteur du siège. Altura de asiento. 40 cm - 15.75"
- C. Arm height. Hauteur du bras. Altura de brazo. 56 cm - 22.05"
- D. Backrest height. Hauteur du dossier. Altura de respaldo. 81 cm - 31.89"
- E. Depth. Profondeur. Profundidad. 82 cm - 32.28"

### FINISHES. TRAITS. ACABADOS.

---

Finishes for the metal bases. Finitions des bases métalliques. Acabados de las bases metálicas.

---

Polyester powder paint. Peinture polyester en poudre. Pintura poliéster en polvo.

---



Manganese metal.  
Métal manganèse.  
Metal manganeso.

Finishes for the feet. Finitions des pieds. Acabados de las patas.

---

Low density polyethylene. Polyéthylène basse densité. Polietileno de baja densidad.

---



LDPE  
PEBD

## SERENE.

PRICES. PRIX. PRECIOS.

SERENE. Armchairs. Fauteuils. Butacas.



### SERB74BTBBBE

74 x 82 H81  
29.13" x 32.28" H31.88"

Standard LDPE bases. Upholstered base. Low arm. Bases PEBD standard. Base tapissée. Bras bas. Bases LDPE standard. Base tapizada. Brazo bajo.



### SERB74BTBBFP

74 x 82 H81  
29.13" x 32.28" H31.88"

Flat metal base, fixed. Upholstered base. Low arm. Base métallique avec socle plat, fixe. Base tapissée. Bras bas. Base métálica plana fija. Base tapizada. Brazo bajo.



### SERB74BTBBGP

74 x 82 H81  
29.13" x 32.28" H31.88"

Flat metal base rotating with auto-return. Upholstered base. Low arm. Base métallique avec socle plat pivotante avec retour automatique. Base tapissée. Bras bas. Base métálica plana giratoria con retorno. Base tapizada. Brazo bajo.

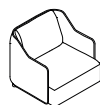

### SERB90BTBBBE

90 x 87 H81  
35.43" x 34.25" H31.88"

Standard LDPE bases. Upholstered base. Low arm. Bases PEBD standard. Base tapissée. Bras bas. Bases LDPE standard. Base tapizada. Brazo bajo.

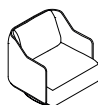

### SERB90BTBBFP

90 x 87 H81  
35.43" x 34.25" H31.88"

Flat metal base, fixed. Upholstered base. Low arm. Base métallique avec socle plat, fixe. Base tapissée. Bras bas. Base métálica plana fija. Base tapizada. Brazo bajo.

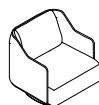

### SERB90BTBBGP

90 x 87 H81  
35.43" x 34.25" H31.88"

Flat metal base rotating with auto-return. Upholstered base. Low arm. Base métallique avec socle plat pivotante avec retour automatique. Base tapissée. Bras bas. Base métálica plana giratoria con retorno. Base tapizada. Brazo bajo.

| MEASUREMENT. MESURE. MEDIDA.          | REF.         | M.L. | COM / COL | 1        | 2        | 3        | 4        | 5        | L1       | L2       |
|---------------------------------------|--------------|------|-----------|----------|----------|----------|----------|----------|----------|----------|
| 74 x 82 H81   29.13" x 32.28" H31.88" | SERB74BTBBBE | 5    | 1.177,69  | 1.231,40 | 1.285,12 | 1.355,37 | 1.483,47 | 1.723,14 | 1.772,73 | 2.012,40 |
| 74 x 82 H81   29.13" x 32.28" H31.88" | SERB74BTBBFP | 5    | 1.537,19  | 1.590,91 | 1.652,89 | 1.723,14 | 1.842,98 | 2.082,64 | 2.132,23 | 2.380,17 |
| 74 x 82 H81   29.13" x 32.28" H31.88" | SERB74BTBBGP | 5    | 1.537,19  | 1.590,91 | 1.652,89 | 1.723,14 | 1.842,98 | 2.082,64 | 2.132,23 | 2.380,17 |
| 90 x 87 H81   35.43" x 34.25" H31.88" | SERB90BTBBBE | 5.5  | 1.371,90  | 1.404,96 | 1.491,74 | 1.561,98 | 1.731,40 | 2.028,93 | 2.082,64 | 2.380,17 |
| 90 x 87 H81   35.43" x 34.25" H31.88" | SERB90BTBBFP | 5.5  | 1.731,40  | 1.772,73 | 1.851,24 | 1.942,15 | 2.099,17 | 2.380,17 | 2.450,41 | 2.735,54 |
| 90 x 87 H81   35.43" x 34.25" H31.88" | SERB90BTBBGP | 5.5  | 1.731,40  | 1.772,73 | 1.851,24 | 1.942,15 | 2.099,17 | 2.380,17 | 2.450,41 | 2.735,54 |



# SERENE.

# CHAIR. CHAISE. SILLA.



Designer  
Mario Ruiz

STYLE. ESTILO.  
Singular

VERSION. VERSIÓN.  
Suspended base. Base suspendue. Base suspendida.

## FEATURES. TRAITS. CARACTERÍSTICAS.

---

### Fixed upholstery.

Wooden frame covered with flexible cold shaped polyurethane foam and polyester fibre.

Seat, back and arms in different polyurethane foam densities, with surface padding in fibre.

Two types of bases to choose from: a cross metal base with LDPE stops or a flat disc metal base with felt. All metallic elements are coated with manganese coloured polyester powder paint.

### Tapiserie fixe.

Cadre en bois recouvert de mousse de polyuréthane souple à froid et de fibre de polyester.

Assise, dossier et accoudoirs réalisés dans différentes densités de mousse polyuréthane, matelassés en surface avec du fibre.

Deux types de bases sont proposés : base métallique en croix avec patins en PEBD ou base métallique avec socle rond recouvert de feutre. Tous les éléments métalliques sont recouverts de peinture polyester en poudre couleur manganèse.

### Tapizado fijo.

Bastidor de madera recubierto de espuma de poliuretano flexible en frío y fibra de poliéster.

Asiento, respaldo y brazos realizados en distintas densidades de espuma de poliuretano, acolchados en la superficie con fibra.

Dos tipos de bases a escoger: Base metálica en cruz con topes de LDPE o base metálica de disco con fieltro. Todos los elementos metálicos están recubiertos en pintura poliéster en polvo color manganeso.



## SERENE.

### GENERAL MEASUREMENTS. MESURES GÉNÉRALES. MEDIDAS GENERALES.

---

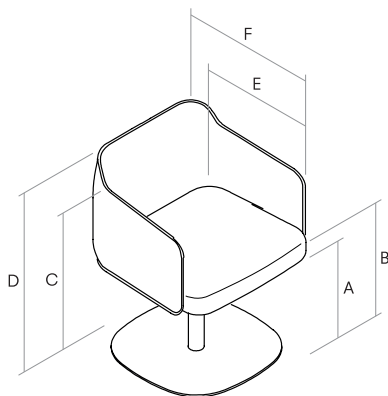

- A. Base height. Hauteur de base. Altura de base. 37 cm - 14.57"
- B. Seat height. Hauteur du siège. Altura de asiento. 46 cm - 18.11"
- C. Arm height. Hauteur du bras. Altura de brazo. 68 cm - 26.77"
- D. Backrest height. Hauteur du dossier. Altura de respaldo. 78 cm - 30.71"
- E. Seat depth. Profondeur d'assise. Profundidad de sentada. 45 cm - 16.54"
- F. Depth. Profondeur. Profundidad. 58 cm - 22.83"

### FINISHES. TRAITS. ACABADOS.

---

Finishes for the metal bases. Finitions des bases métalliques. Acabados de las bases metálicas.

---

Polyester powder paint. Peinture polyester en poudre. Pintura poliéster en polvo.

---



Manganese metal.  
Métal manganèse.  
Metal manganeso.

SERENE.

PRICES. PRIX. PRECIOS.

SERENE. Armchairs. Fauteuils. Butacas.



**SERCHR59BSFP**

59 x 58 H78  
23.22" x 22.83" H30.70"

Flat metal base, fixed. Suspended base. Base métallique avec socle plat, fixe. Base suspendue. Base metálica plana fija. Base suspendida.



**SERCHR59BSFC**

59 x 58 H78  
23.22" x 22.83" H30.70"

Cross-shaped metal base, fixed. Suspended base. Base métallique en croix, fixe. Base suspendue. Base metálica en cruz fija. Base suspendida.



**SERCHR59BSGP**

59 x 58 H78  
23.22" x 22.83" H30.70"

Flat metal base rotating with auto-return. Suspended base. Base métallique avec socle plat pivotante avec retour automatique. Base suspendue. Base metálica plana giratoria con retorno. Base suspendida.



**SERCHR59BSGC**

59 x 58 H78  
23.22" x 22.83" H30.70"

Cross-shaped metal base rotating with auto-return. Suspended base. Base métallique en croix, pivotante avec retour automatique. Base suspendue. Base metálica en cruz giratoria con retorno. Base suspendida.

| MEASUREMENT. MESURE. MEDIDA.          | REF.         | M.L. | COM / COL | 1      | 2      | 3      | 4        | 5        | L1       | L2       |
|---------------------------------------|--------------|------|-----------|--------|--------|--------|----------|----------|----------|----------|
| 59 x 58 H78   23.22" x 22.83" H30.70" | SERCHR59BSFP | 2    | 801,65    | 809,92 | 826,45 | 847,11 | 888,43   | 958,68   | 975,21   | 1.045,45 |
| 59 x 58 H78   23.22" x 22.83" H30.70" | SERCHR59BSFC | 2    | 801,65    | 809,92 | 826,45 | 847,11 | 888,43   | 958,68   | 975,21   | 1.045,45 |
| 59 x 58 H78   23.22" x 22.83" H30.70" | SERCHR59BSGP | 2    | 917,36    | 925,62 | 950,41 | 975,21 | 1.000,00 | 1.074,38 | 1.090,91 | 1.161,16 |
| 59 x 58 H78   23.22" x 22.83" H30.70" | SERCHR59BSGC | 2    | 917,36    | 925,62 | 950,41 | 975,21 | 1.000,00 | 1.074,38 | 1.090,91 | 1.161,16 |



# SERENE.

# CHAIR. CHAISE. SILLA.



Designer  
Mario Ruiz

STYLE. ESTILO.  
Singular

VERSION. VERSIÓN.  
Floor standing. Ras du sol. Base a suelo.

## FEATURES. TRAITS. CARACTERÍSTICAS.

---

### Fixed upholstery.

Wooden frame covered with flexible cold shaped polyurethane foam and polyester fibre.

Seat, back and arms in different polyurethane foam densities, with surface padding in fibre.

Two types of bases to choose from: LDPE bases or a flat disc metal base with felt, coated with manganese coloured polyester powder paint.

### Tapiserie fixe.

Cadre en bois recouvert de mousse de polyuréthane souple à froid et de fibre de polyester.

Assise, dossier et accoudoirs réalisés dans différentes densités de mousse polyuréthane, matelassés en surface avec du fibre.

Deux types de bases sont proposés : Pieds en PEBD ou base métallique avec socle rond recouvert de feutre, recouverts de peinture polyester en poudre couleur manganèse.

### Tapizado fijo.

Bastidor de madera recubierto de espuma de poliuretano flexible en frío y fibra de poliéster.

Asiento, respaldo y brazos realizados en distintas densidades de espuma de poliuretano, acolchados en la superficie con fibra.

Dos tipos de bases a escoger: Bases fabricadas en LDPE con protectores de fieltro o base metálica de disco con fieltro recubierta en pintura poliéster en polvo color manganeso.

## SERENE.

### GENERAL MEASUREMENTS. MESURES GÉNÉRALES. MEDIDAS GENERALES.

---

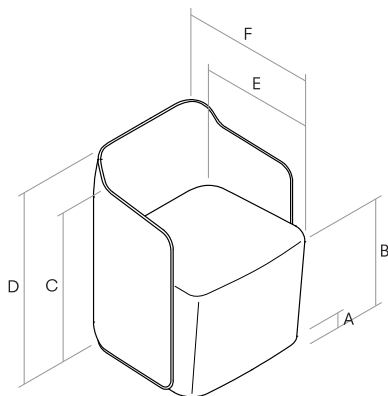

- A.** Base height. Hauteur de base. Altura de base. 3 cm - 1.18"
- B.** Seat height. Hauteur du siège. Altura de asiento. 46 cm - 18.11"
- C.** Arm height. Hauteur du bras. Altura de brazo. 68 cm - 26.77"
- D.** Backrest height. Hauteur du dossier. Altura de respaldo. 78 cm - 30.71"
- E.** Seat depth. Profondeur d'assise. Profundidad de sentada. 45 cm - 16.54"
- F.** Depth. Profondeur. Profundidad. 58 cm - 22.83"

### FINISHES. TRAITS. ACABADOS.

---

Finishes for the metal bases. Finitions des bases métalliques. Acabados de las bases metálicas.

---

Polyester powder paint. Peinture polyester en poudre. Pintura poliéster en polvo.

---



Manganese metal.  
Métal manganèse.  
Metal manganeso.

Finishes for the feet. Finitions des pieds. Acabados de las patas.

---

Low density polyethylene. Polyéthylène basse densité. Polietileno de baja densidad.

---



LDPE  
PEBD

## SERENE.

PRICES. PRIX. PRECIOS.

SERENE. Armchairs. Fauteuils. Butacas.



### SERCHR59BTBE

59 x 58 H78  
23.22" x 22.83" H30.70"

Standard LDPE bases. Upholstered base. Bases PEED standard. Base tapissée. Bases LDPE standard. Base tapizada.



### SERCHR59BTFP

59 x 58 H78  
23.22" x 22.83" H30.70"

Flat metal base, fixed. Upholstered base. Base métallique avec socle plat, fixe. Base tapissée. Base metálica plana fija. Base tapizada.



### SERCHR59BTGP

59 x 58 H78  
23.22" x 22.83" H30.70"

Flat metal base rotating with auto-return. Upholstered base. Base métallique avec socle plat pivotante avec retour automatique. Base tapissée. Base metálica plana giratoria con retorno. Base tapizada.

| MEASUREMENT. MESURE. MEDIDA.          | REF.         | M.L. | COM / COL | 1        | 2        | 3        | 4        | 5        | L1       | L2       |
|---------------------------------------|--------------|------|-----------|----------|----------|----------|----------|----------|----------|----------|
| 59 x 58 H78   23.22" x 22.83" H30.70" | SERCHR59BTBE | 3    | 652,89    | 665,29   | 698,35   | 731,40   | 793,39   | 904,96   | 933,88   | 1.045,45 |
| 59 x 58 H78   23.22" x 22.83" H30.70" | SERCHR59BTFP | 3    | 880,17    | 896,69   | 933,88   | 958,68   | 1.020,66 | 1.136,36 | 1.161,16 | 1.272,73 |
| 59 x 58 H78   23.22" x 22.83" H30.70" | SERCHR59BTGP | 3    | 1.012,40  | 1.028,93 | 1.066,12 | 1.090,91 | 1.152,89 | 1.264,46 | 1.293,39 | 1.413,22 |



# TIME.

# ARMCHAIR. FAUTEUIL. BUTACA.



Designer  
Mario Ruiz

STYLE. ESTILO.  
Cozy

## FEATURES. TRAITS. CARACTERÍSTICAS.

---

Removable upholstery in back cushion.

Wooden frame covered with flexible cold shaped polyurethane foam and polyester fibre.

Suspension consisting of elasticated webbing in different tensions.

Seat in different polyurethane foam densities, with surface padding in fibre. Back cushion stuffed with polyester fibre and washed, sterilised down.

Three types of bases to choose from: solid oak feet in a natural finish, a cross metal base with LDPE stops, or a metal flat disc base with felt. All metallic elements are coated with manganese coloured polyester powder paint.

Tapiserie déhoussable sur le coussin du dossier.

Cadre en bois recouvert de mousse de polyuréthane souple à froid et de fibre de polyester.

Suspension au moyen de sangles élastiques entrelacées de différentes tensions.

Assise réalisé dans différentes densités de mousse polyuréthane, matelassé en surface avec du fibre. Coussin du dossier garni de fibre de polyester et plumes lavées et stérilisées.

Trois types de bases sont proposés: pieds en chêne massif finition naturelle, base métallique en croix avec patins en PEBD ou base métallique avec socle rond recouvert de feutre. Tous les éléments métalliques sont recouverts de peinture polyester en poudre couleur manganèse.

Tapicería desenfundable en cojín de respaldo.

Bastidor de madera recubierto de espuma de poliuretano flexible en frío y fibra de poliéster.

Suspensión mediante cinchas elásticas entrelazadas de diferentes tensiones.

Asiento realizado en distintas densidades de espuma de poliuretano, acolchado en la superficie con fibra. Cojín de respaldo relleno de fibra de poliéster y pluma lavada y esterilizada.

Tres tipos de bases a escoger: pies de roble macizo en acabado natural, base metálica en cruz con topes de LDPE o base metálica de disco con fieltro. Todos los elementos metálicos están recubiertos en pintura poliéster en polvo color manganeso.



## SERENE.

### GENERAL MEASUREMENTS. MESURES GÉNÉRALES. MEDIDAS GENERALES.

---

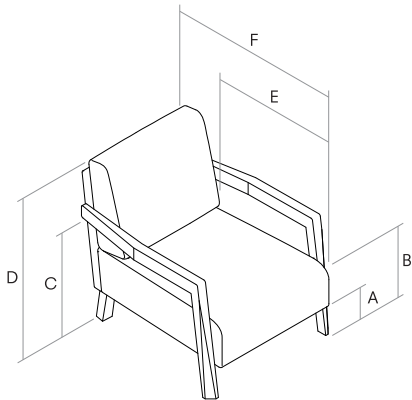

- A. Base height. Hauteur de base. Altura de base. 15 cm - 5.91"
- B. Seat height. Hauteur du siège. Altura de asiento. 42 cm - 16.54"
- C. Arm height. Hauteur des bras. Altura de brazo. 68 cm - 26.77"
- D. Backrest height. Hauteur du dossier. Altura de respaldo. 82 cm - 32.28"
- E. Seat depth. Profondeur d'assise. Profundidad de asiento. 57 cm - 22.44"
- F. Depth. Profondeur. Profundidad. 88 cm - 34.65"

### FINISHES. TRAITS. ACABADOS.

---

Finishes for the metal bases. Finitions des bases métalliques. Acabados de las bases metálicas.

---

Polyester powder paint. Peinture polyester en poudre. Pintura poliéster en polvo.

---



Manganese metal.  
Métal manganèse.  
Metal manganeso.

Finishes for the wooden feet. Finitions des pieds en bois. Acabados de los pies en madera.

---

Wood finishes. Finitions bois. Acabado de la madera.

---



Natural oak.  
Chêne naturel.  
Roble natural.

## SERENE.

PRICES. PRIX. PRECIOS.

SERENE. Armchairs. Fauteuils. Butacas.



### TIMB70BE

70 x 88 H82  
27.55" x 34.64" H32.28"

Standard wood bases.  
Bases en bois standard.  
Bases en madera standard.



### TIMB70FP

60 x 88 H82  
23.62" x 34.64" H32.28"

Flat metal base, fixed.  
Base métallique avec socle plat, fixe.  
Base metálica plana fija.



### TIMB70FC

60 x 88 H82  
23.62" x 34.64" H32.28"

Cross-shaped metal base, fixed.  
Base métallique en croix, fixe.  
Base metálica en cruz fija.



### TIMB70GP

60 x 88 H82  
23.62" x 34.64" H32.28"

Flat metal base rotating with auto-return. Base métallique avec socle plat pivotante avec retour automatique.  
Base metálica plana giratoria con retorno.



### TIMB70GC

60 x 88 H82  
23.62" x 34.64" H32.28"

Cross-shaped metal base rotating with auto-return. Base métallique en croix, pivotante avec retour automatique. Base metálica en cruz giratoria con retorno.

| MEASUREMENT. MESURE. MEDIDA.          | REF.     | M.L. | COM / COL | 1        | 2        | 3        | 4        | 5        | L1       | L2       |
|---------------------------------------|----------|------|-----------|----------|----------|----------|----------|----------|----------|----------|
| 70 x 88 H82   27.55" x 34.64" H32.28" | TIMB70BE | 3    | 1.433,88  | 1.475,21 | 1.520,66 | 1.561,98 | 1.669,42 | 1.834,71 | 1.871,90 | 2.070,25 |
| 60 x 88 H82   23.62" x 34.64" H32.28" | TIMB70FP | 3    | 1.309,92  | 1.342,98 | 1.388,43 | 1.433,88 | 1.537,19 | 1.710,74 | 1.739,67 | 1.942,15 |
| 60 x 88 H82   23.62" x 34.64" H32.28" | TIMB70FC | 3    | 1.309,92  | 1.342,98 | 1.388,43 | 1.433,88 | 1.537,19 | 1.710,74 | 1.739,67 | 1.942,15 |
| 60 x 88 H82   23.62" x 34.64" H32.28" | TIMB70GP | 3    | 1.404,96  | 1.433,88 | 1.491,74 | 1.537,19 | 1.615,70 | 1.780,99 | 1.834,71 | 2.028,93 |
| 60 x 88 H82   23.62" x 34.64" H32.28" | TIMB70GC | 3    | 1.404,96  | 1.433,88 | 1.491,74 | 1.537,19 | 1.615,70 | 1.780,99 | 1.834,71 | 2.028,93 |



# VENICE.

# ARMCHAIR. FAUTEUIL. BUTACA.



Designer  
Mario Ruiz

STYLE. ESTILO.  
New Classic

VERSION. VERSIÓN.  
Visible base version. Version base visible. Versión base visible.

## FEATURES. TRAITS. CARACTERÍSTICAS.

---

Completely removable upholstery. In leather, seat and back cushion with removable covers.

Wooden frame covered with flexible cold shaped polyurethane foam and polyester fibre.

Suspension consisting of elasticated webbing in different tensions.

Seat cushion made with polyurethane foam insert, padded with fibre, and washed, sterilised down. Back cushion stuffed with polyester fibre and washed, sterilised down.

Four types of bases to choose from: solid oak feet in a natural finish, U-shaped metal feet with LDPE stops, a cross metal base with LDPE stops, or a metal flat disc base with felt. All metallic elements are coated with manganese coloured polyester powder paint.

Tapiserie entièrement déhoussable. En cuir, coussin de l'assise et coussin du dossier déhoussables.

Cadre en bois recouvert de mousse de polyuréthane souple à froid et de fibre de polyester.

Suspension au moyen de sangles élastiques entrelacées de différentes tensions.

Coussin de l'assise garni de mousse polyuréthane, matelassé avec de la fibre et des plumes lavées et stérilisées. Coussin du dossier garni de fibre de polyester et plumes lavées et stérilisées.

Quatre types de bases sont proposés: pieds en chêne massif finition naturelle, pieds en métal en forme de U avec patins en PEBD, base métallique en croix avec patins en PEBD ou base métallique avec socle rond recouvert de feutre. Tous les éléments métalliques sont recouverts de peinture polyester en poudre couleur manganèse.

Tapicería totalmente desenfundable. En piel, cojín de asiento y respaldo desenfundables.

Bastidor de madera recubierto de espuma de poliuretano flexible en frío y fibra de poliéster.

Suspensión mediante cinchas elásticas entrelazadas de diferentes tensiones.

Cojín de asiento realizado con inserto de espuma de poliuretano, acolchado con fibra y pluma lavada y esterilizada. Cojín de respaldo relleno de fibra de poliéster y pluma lavada y esterilizada.

Cuatro tipos de bases a escoger: pies de roble macizo en acabado natural, pies metálicos en forma de U con topes de LDPE, base metálica en cruz con topes de LDPE o base metálica de disco con fieltro. Todos los elementos metálicos están recubiertos en pintura poliéster en polvo color manganeso.

## VENICE.

### GENERAL MEASUREMENTS. MESURES GÉNÉRALES. MEDIDAS GENERALES.

---

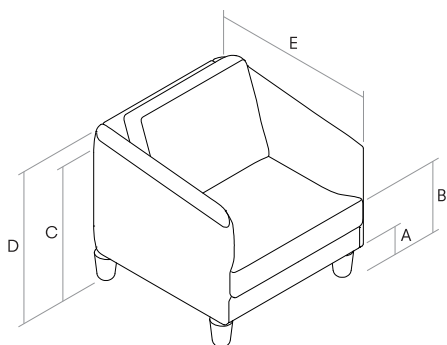

- A. Base height. Hauteur de base. Altura de base. 15 cm - 5.91"
- B. Seat height. Hauteur du siège. Altura de asiento. 44 cm - 17.32"
- C. Arm height. Hauteur du bras. Altura de brazo. 62 cm - 24.41"
- D. Backrest height. Hauteur du dossier. Altura de respaldo. 80 cm - 31.50"
- E. Depth. Profondeur. Profundidad. 79 cm - 31.10"

### FINISHES. TRAITS. ACABADOS.

---

Finishes for the metal bases. Finitions des bases métalliques. Acabados de las bases metálicas.

---

Polyester powder paint. Peinture polyester en poudre. Pintura poliéster en polvo.

---



Manganese metal.  
Métal manganèse.  
Metal manganeso.

Finishes for the wooden feet. Finitions des pieds en bois. Acabados de los pies en madera.

---

Wood finishes. Finitions bois. Acabado de la madera.

---



Natural oak.  
Chêne naturel.  
Roble natural.



**RT**  
Dark stained oak.  
Chêne teint foncée.  
Roble teñido oscuro.



**RL**  
Oak painted in black with open-pore finish.  
Chêne laqué noir à pores ouverts.  
Roble lacado negro por abierto.

## VENICE.

PRICES. PRIX. PRECIOS.

VENICE. Armchairs. Fauteuils. Butacas.



### VENB78BE

78 x 79 H80  
30.70" x 31.10" H31.49"

Standard wood bases.  
Bases en bois standard.  
Bases en madera standard.



### VENB78ME

78 x 79 H80  
30.70" x 31.10" H31.49"

Optional metal bases.  
Bases métalliques en option.  
Bases metálicas opcionales..



### VENB78FP

78 x 79 H80  
30.70" x 31.10" H31.49"

Flat metal base, fixed.  
Base métallique avec socle plat, fixe.  
Base metálica plana fija.



### VENB78FC

78 x 79 H80  
30.70" x 31.10" H31.49"

Cross-shaped metal base, fixed.  
Base métallique en croix, fixe.  
Base metálica en cruz fija.



### VENB78GP

78 x 79 H80  
30.70" x 31.10" H31.49"

Flat metal base rotating with auto-return. Base métallique avec socle plat pivotante avec retour automatique.  
Base metálica plana giratoria con retorno.



### VENB78GC

78 x 79 H80  
30.70" x 31.10" H31.49"

Cross-shaped metal base rotating with auto-return. Base métallique en croix, pivotante avec retour automatique. Base metálica en cruz giratoria con retorno.

| MEASUREMENT. MESURE. MEDIDA.          | REF.     | M.L. | COM / COL | 1        | 2        | 3        | 4        | 5        | L1       | L2       |
|---------------------------------------|----------|------|-----------|----------|----------|----------|----------|----------|----------|----------|
| 78 x 79 H80   30.70" x 31.10" H31.49" | VENB78BE | 4    | 1.363,64  | 1.396,69 | 1.458,68 | 1.504,13 | 1.615,70 | 1.818,18 | 1.859,50 | 2.037,19 |
| 78 x 79 H80   30.70" x 31.10" H31.49" | VENB78ME | 4    | 1.363,64  | 1.396,69 | 1.458,68 | 1.504,13 | 1.615,70 | 1.818,18 | 1.859,50 | 2.037,19 |
| 78 x 79 H80   30.70" x 31.10" H31.49" | VENB78FP | 4    | 1.553,72  | 1.615,70 | 1.652,89 | 1.723,14 | 1.818,18 | 2.020,66 | 2.061,98 | 2.247,93 |
| 78 x 79 H80   30.70" x 31.10" H31.49" | VENB78FC | 4    | 1.553,72  | 1.615,70 | 1.652,89 | 1.723,14 | 1.818,18 | 2.020,66 | 2.061,98 | 2.247,93 |
| 78 x 79 H80   30.70" x 31.10" H31.49" | VENB78GP | 4    | 1.632,23  | 1.661,16 | 1.723,14 | 1.764,46 | 1.888,43 | 2.090,91 | 2.123,97 | 2.326,45 |
| 78 x 79 H80   30.70" x 31.10" H31.49" | VENB78GC | 4    | 1.632,23  | 1.661,16 | 1.723,14 | 1.764,46 | 1.888,43 | 2.090,91 | 2.123,97 | 2.326,45 |

VENICE.

PRICES. PRIX. PRECIOS.

VENICE. Armchairs. Fauteuils. Butacas.



**VENB71BE**

71 x 72 H71  
27.95" x 28.34" H27.95"



**VENB71FP**

71 x 72 H71  
27.95" x 28.34" H27.95"



**VENB71GP**

71 x 72 H71  
27.95" x 28.34" H27.95"

| MEASUREMENT. MESURE. MEDIDA.          | REF.     | M.L. | COM / COL | 1        | 2        | 3        | 4        | 5        | L1       | L2       |
|---------------------------------------|----------|------|-----------|----------|----------|----------|----------|----------|----------|----------|
| 71 x 72 H71   27.95" x 28.34" H27.95" | VENB71BE | 3    | 1.004,13  | 1.020,66 | 1.074,38 | 1.115,70 | 1.177,69 | 1.371,90 | 1.396,69 | 1.528,93 |
| 71 x 72 H71   27.95" x 28.34" H27.95" | VENB71FP | 3    | 1.144,63  | 1.169,42 | 1.231,40 | 1.256,20 | 1.326,45 | 1.491,74 | 1.520,66 | 1.677,69 |
| 71 x 72 H71   27.95" x 28.34" H27.95" | VENB71GP | 3    | 1.144,63  | 1.169,42 | 1.231,40 | 1.256,20 | 1.326,45 | 1.491,74 | 1.520,66 | 1.677,69 |

# VENICE.

# ARMCHAIR. FAUTEUIL. BUTACA.



Designer  
Mario Ruiz

STYLE. ESTILO.  
New Classic

VERSION. VERSIÓN.  
Fabric cover version. Version jupe. Versión faldón.

## FEATURES. TRAITS. CARACTERÍSTICAS.

---

Completely removable upholstery.  
Not available in leather.

Wooden frame covered with flexible  
cold shaped polyurethane foam and  
polyester fibre.

Suspension consisting of elasticated  
webbing in different tensions.

Seat cushion made with polyurethane  
foam insert, padded with fibre and  
washed, sterilised down. Back  
cushion stuffed with polyester fibre  
and washed, sterilised down.

Two types of bases to choose from:  
solid oak feet in a natural finish or a  
U-shaped metal feet with LDPE stops  
coated with manganese coloured  
polyester powder paint.

Tapiserie entièrement déhoussable.  
Non-disponible en cuir.

Cadre en bois recouvert de mousse  
de polyuréthane souple à froid et de  
fibre de polyester.

Suspension au moyen de sangles  
élastiques entrelacées de différentes  
tensions.

Coussin de l'assise garni de mousse  
polyuréthane, matelassé avec de  
la fibre et des plumes lavées et  
stérilisées. Coussin du dossier garni  
de fibre de polyester et plumes lavées  
et stérilisées.

Deux types de bases sont proposés:  
pieds en chêne massif finition  
naturelle ou pieds en métal en forme  
de U avec patins en PEBD, recouverts  
de peinture polyester en poudre  
couleur manganèse.

Tapicería totalmente desenfundable.  
No disponible en piel.

Bastidor de madera recubierto de  
espuma de poliuretano flexible en frío  
y fibra de poliéster.

Suspensión mediante cinchas  
elásticas entrelazadas de diferentes  
tensiones.

Cojín de asiento realizado con  
inserto de espuma de poliuretano,  
acolchado con fibra y pluma lavada y  
esterilizada. Cojín de respaldo  
relleno de fibra de poliéster y pluma lavada y  
esterilizada.

Dos tipos de bases a escoger: pies  
de roble macizo en acabado natural y  
pies metálicos recubiertos en pintura  
poliéster en polvo color manganeso,  
en forma de U con topes de LDPE.



## VENICE.

### GENERAL MEASUREMENTS. MESURES GÉNÉRALES. MEDIDAS GENERALES.

---

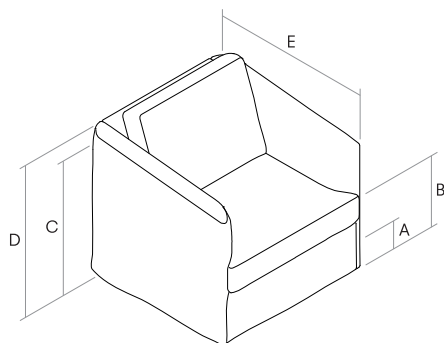

- A. Base height. Hauteur de base. Altura de base. 15 cm - 5.91"
- B. Seat height. Hauteur du siège. Altura de asiento. 44 cm - 17.32"
- C. Arm height. Hauteur du bras. Altura de brazo. 62 cm - 24.41"
- D. Backrest height. Hauteur du dossier. Altura de respaldo. 80 cm - 31.50"
- E. Depth. Profondeur. Profundidad. 79 cm - 31.10"

### FINISHES. TRAITS. ACABADOS.

---

Finishes for the metal bases. Finitions des bases métalliques. Acabados de las bases metálicas.

---

Polyester powder paint. Peinture polyester en poudre. Pintura poliéster en polvo.

---



Manganese metal.  
Métal manganèse.  
Metal manganeso.

Finishes for the wooden feet. Finitions des pieds en bois. Acabados de los pies en madera.

---

Wood finishes. Finitions bois. Acabado de la madera.

---



Natural oak.  
Chêne naturel.  
Roble natural.

Finishes for the feet. Finitions des pieds. Acabados de las patas.

---

Low density polyethylene. Polyéthylène basse densité. Polietileno de baja densidad.

---



LDPE  
PEBD

VENICE.

PRICES. PRIX. PRECIOS.

VENICE. Armchairs. Fauteuils. Butacas.



**VENB71BEFA**

71 x 72 H71  
27.95" x 28.34" H27.95"

Standard LDPE bases. Fabric cover version. Bases PEBD standard. Version jupe. Bases LDPE standard. Versión faldón.



**VENB78BEFA**

78 x 79 H80  
30.70" x 31.10" H31.49"

Standard wood bases. Bases en bois standard. Bases en madera standard.



**VENB78MEFA**

78 x 79 H80  
30.70" x 31.10" H31.49"

Optional metal bases. Bases métalliques en option. Bases metálicas opcionales..

| MEASUREMENT. MESURE. MEDIDA.          | REF.       | M.L. | COM / COL | 1        | 2        | 3        | 4        | 5        |
|---------------------------------------|------------|------|-----------|----------|----------|----------|----------|----------|
| 71 x 72 H71   27.95" x 28.34" H27.95" | VENB71BEFA | 3.5  | 1.012,40  | 1.028,93 | 1.082,64 | 1.123,97 | 1.194,21 | 1.380,17 |
| 78 x 79 H80   30.70" x 31.10" H31.49" | VENB78BEFA | 4.5  | 1.371,90  | 1.413,22 | 1.475,21 | 1.528,93 | 1.661,16 | 1.904,96 |
| 78 x 79 H80   30.70" x 31.10" H31.49" | VENB78MEFA | 4.5  | 1.371,90  | 1.413,22 | 1.475,21 | 1.528,93 | 1.661,16 | 1.904,96 |





Designer  
Mario Ruiz

STYLE. ESTILO.  
Essential

## FEATURES. TRAITS. CARACTERÍSTICAS.

---

### Fixed upholstery.

Wooden frame covered with flexible cold shaped polyurethane foam.

Seat made in different polyurethane foam densities, with surface padding in fibre.

LDPE bases.

### Tapiserie fixée.

Cadre en bois recouvert de mousse de polyuréthane souple à froid et de fibre de polyester.

Assise réalisée dans différentes densités de mousse polyuréthane, matelassée en surface avec du fibre.

Bases en PEBD.

### Tapizado fijo.

Bastidor de madera recubierto de espuma de poliuretano flexible en frío y fibra de poliéster.

Asiento realizado en distintas densidades de espuma de poliuretano, acolchado en la superficie con fibra.

Bases en LDPE.

DEPART.

GENERAL MEASUREMENTS. MESURES GÉNÉRALES. MEDIDAS GENERALES.

---

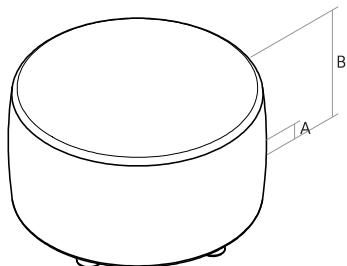

**A.** Feet height. Hauteur du pied. Altura de la pata. 5 cm - 1.97"

**B.** Height. Hauteur. Altura. 39 cm - 15.35"

FINISHES. TRAITS. ACABADOS.

---

Finishes for the feet. Finitions des pieds. Acabados de las patas.

---

Low density polyethylene. Polyéthylène basse densité. Polietileno de baja densidad.

---



LDPE  
PEBD

DEPART.

PRICES. PRIX. PRECIOS.

---

DEPART. Ottomans. Poufs. Ottomans.

---



**DEPP43B**

43 x 43 H39  
16.93"x 16.93" H15.35"



**DEPP63B**

63 x 63 H39  
24.80"x 24.80" H15.35"



**DEPP93B**

93 x 93 H39  
36.61"x 36.61" H15.35"

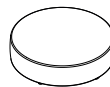

**DEPP138B**

138 x 138 H39  
54.33"x 54.33" H15.35"



**DEPP43A**

43 x 43 H46  
16.93"x 16.93" H18.11"

| MEASUREMENT. MESURE. MEDIDA.           | REF.     | M.L. | COM / COL | 1        | 2        | 3        | 4        | 5        | L1       | L2       |
|--|----------|------|-----------|----------|----------|----------|----------|----------|----------|----------|
| 43 x 43 H39   16.93"x 16.93" H15.35"   | DEPP43B  | 1.5  | 371,90    | 380,17   | 396,69   | 409,09   | 433,88   | 479,34   | 512,40   | 557,85   |
| 63 x 63 H39   24.8"x 24.8" H15.35"     | DEPP63B  | 1.5  | 512,40    | 528,93   | 549,59   | 566,12   | 607,44   | 677,69   | 698,35   | 776,86   |
| 93 x 93 H39   36.61"x 36.61" H15.35"   | DEPP93B  | 2.5  | 747,93    | 756,20   | 793,39   | 818,18   | 896,69   | 995,87   | 1.020,66 | 1.123,97 |
| 138 x 138 H39   54.33"x 54.33" H15.35" | DEPP138B | 3.5  | 1.326,45  | 1.363,64 | 1.404,96 | 1.458,68 | 1.528,93 | 1.702,48 | 1.731,40 | 1.888,43 |
| 43 x 43 H46   16.93"x 16.93" H18.11"   | DEPP43A  | 1.5  | 429,75    | 438,02   | 446,28   | 454,55   | 479,34   | 533,06   | 561,98   | 595,04   |





Designer  
Mario Ruiz

STYLE. ESTILO.  
Essential

## FEATURES. TRAITS. CARACTERÍSTICAS.

---

Fixed upholstery.

Wooden frame covered with flexible cold shaped polyurethane foam.

Seat made in different polyurethane foam densities, with surface padding in fibre.

LDPE bases.

Tapiserie fixée.

Cadre en bois recouvert de mousse de polyuréthane souple à froid et de fibre de polyester.

Assise réalisée dans différentes densités de mousse polyuréthane, matelassée en surface avec du fibre.

Bases en PEBD.

Tapizado fijo.

Bastidor de madera recubierto de espuma de poliuretano flexible en frío y fibra de poliéster.

Asiento realizado en distintas densidades de espuma de poliuretano, acolchado en la superficie con fibra.

Bases en LDPE.



DEPART SQ.

GENERAL MEASUREMENTS. MESURES GÉNÉRALES. MEDIDAS GENERALES.

---

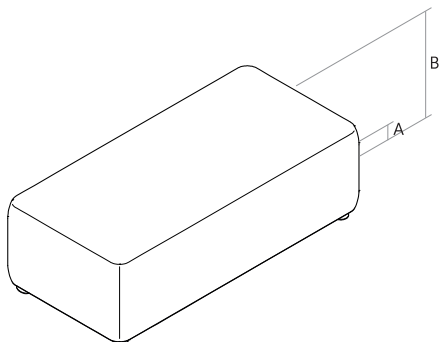

**A.** Feet height. Hauteur du pied. Altura de la pata. 5 cm - 1.97"

**B.** Height. Hauteur. Altura. 39 cm - 15.35"

FINISHES. TRAITS. ACABADOS.

---

Finishes for the feet. Finitions des pieds. Acabados de las patas.

---

Low density polyethylene. Polyéthylène basse densité. Polietileno de baja densidad.

---



LDPE  
PEBD

DEPART SQ.

PRICES. PRIX. PRECIOS.

---

DEPART. Ottomans. Poufs. Ottomans.

---



**DEPSQP49**

49 x 49 H39  
19.29" x 19.29" H15.35"



**DEPSQP96**

96 x 96 H39  
37.80" x 37.80" H15.35"



**DEPSQP116R**

116 x 56 H39  
45.67" x 22.05" H15.35"

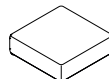

**DEPSQP116C**

116 x 116 H39  
45.67" x 45.67" H15.35"

| MEASUREMENT. MESURE. MEDIDA.            | REF.       | M.L. | COM / COL | 1        | 2        | 3        | 4        | 5        | L1       | L2       |
|---|------------|------|-----------|----------|----------|----------|----------|----------|----------|----------|
| 49 x 49 H39   19.29" x 19.29" H15.35"   | DEPSQP49   | 1.5  | 384,30    | 392,56   | 400,83   | 417,36   | 442,15   | 491,74   | 508,26   | 557,85   |
| 96 x 96 H39   37.8" x 37.8" H15.35"     | DEPSQP96   | 2.5  | 797,52    | 830,58   | 855,37   | 904,96   | 979,34   | 1.111,57 | 1.161,16 | 1.318,18 |
| 116 x 56 H39   45.67" x 22.05" H15.35"  | DEPSQP116R | 2.5  | 690,08    | 714,88   | 731,40   | 764,46   | 814,05   | 904,96   | 946,28   | 1.045,45 |
| 116 x 116 H39   45.67" x 45.67" H15.35" | DEPSQP116C | 3.5  | 1.078,51  | 1.119,83 | 1.144,63 | 1.194,21 | 1.276,86 | 1.417,36 | 1.475,21 | 1.640,50 |





Designer  
Mario Ruiz

STYLE. ESTILO.  
Essential

VERSION. VERSIÓN.  
Elevated base. Cadre haut. Base suspendida.

## FEATURES. TRAITS. CARACTERÍSTICAS.

---

Completely removable upholstery.

Wooden frame covered with flexible cold shaped polyurethane foam.

Seat made in different polyurethane foam densities, with surface padding in fibre.

Bases in MDF, KOKOA lacquered. LPDE and felt stops.

Tapiserie entièrement déhoussable.

Cadre en bois recouvert de mousse de polyuréthane souple à froid et de fibre de polyester.

Assise réalisée dans différentes densités de mousse polyuréthane, matelassée en surface avec du fibre.

Bases en MDF laquée couleur KOKOA. Patins en PEBD et feutre.

Tapicería totalmente desfundable.

Bastidor de madera recubierto de espuma de poliuretano flexible en frío y fibra de poliéster.

Asiento fabricado en distintas densidades de espuma de poliuretano, acolchado en la superficie con fibra.

Bases fabricadas en MDF lacadas en color KOKOA. Protectores de LDPE y fieltro.

SUMA.

GENERAL MEASUREMENTS. MESURES GÉNÉRALES. MEDIDAS GENERALES.

---

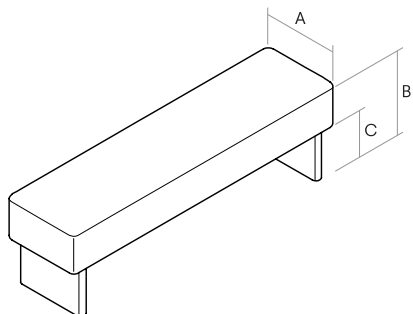

**A.** Base height. Hauteur de base. Altura de base. 22 cm - 8.66"

**B.** Depth. Profondeur. Profundidad. 35 cm - 13.78"

**C.** Height. Hauteur. Altura. 40 cm - 15.75"

FINISHES. TRAITS. ACABADOS.

---

Finishes for the bases. Finitions des pieds. Acabados de las patas.

---

Lacquered. Laqué. Lacados.

---



KOKOA

SUMA.

PRICES. PRIX. PRECIOS.

SUMA. Ottomans. Poufs. Ottomans.



**SUMP95BS**

95 x 35 H40  
37.4"x 13.78" H15.75"

Mattress. Matelas. Colchón.  
105 41.34"



**SUMP135BS**

135 x 35 H40  
53.15"x 13.78" H15.75"

Mattress. Matelas. Colchón.  
150 59.06" | 160 62.99"  
153 60.24"

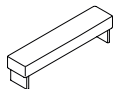

**SUMP165BS**

165 x 35 H40  
64.96"x 13.78" H15.75"

Mattress. Matelas. Colchón.  
180 70.87" | 200 78.74"  
183 72.05" | 193 75.98"

| MEASUREMENT. MESURE. MEDIDA.          | REF.      | M.L. | COM / COL | 1      | 2      | 3      | 4      | 5        | L1       | L2       |
|---------------------------------------|-----------|------|-----------|--------|--------|--------|--------|----------|----------|----------|
| 95 x 35 H40   37.4"x 13.78" H15.75"   | SUMP95BS  | 1.5  | 785,12    | 793,39 | 809,92 | 822,31 | 851,24 | 900,83   | 913,22   | 966,94   |
| 135 x 35 H40   53.15"x 13.78" H15.75" | SUMP135BS | 2    | 867,77    | 880,17 | 896,69 | 921,49 | 958,68 | 1.028,93 | 1.049,59 | 1.119,83 |
| 165 x 35 H40   64.96"x 13.78" H15.75" | SUMP165BS | 2    | 892,56    | 900,83 | 925,62 | 942,15 | 987,60 | 1.057,85 | 1.074,38 | 1.144,63 |





Designer  
Mario Ruiz

STYLE. ESTILO.  
Essential

VERSION. VERSIÓN.  
Floor standing. Ras du sol. Base a suelo.

## FEATURES. TRAITS. CARACTERÍSTICAS.

---

Completely removable upholstery.

Wooden frame covered with flexible cold shaped polyurethane foam.

Seat made in different polyurethane foam densities, with surface padding in fibre.

Bases in MDF, KOKOA lacquered. LPDE and felt stops.

Tapiserie entièrement déhoussable.

Cadre en bois recouvert de mousse de polyuréthane souple à froid et de fibre de polyester.

Assise réalisée dans différentes densités de mousse polyuréthane, matelassée en surface avec du fibre.

Bases en MDF laquée couleur KOKOA. Patins en PEBD et feutre.

Tapicería totalmente desfundable.

Bastidor de madera recubierto de espuma de poliuretano flexible en frío y fibra de poliéster.

Asiento fabricado en distintas densidades de espuma de poliuretano, acolchado en la superficie con fibra.

Bases fabricadas en MDF lacadas en color KOKOA. Protectores de LDPE y fieltro.



SUMA.

GENERAL MEASUREMENTS. MESURES GÉNÉRALES. MEDIDAS GENERALES.

---

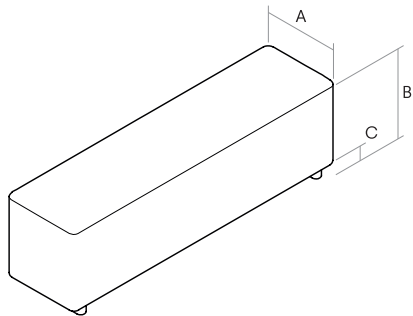

**A.** Base height. Hauteur de base. Altura de base. 4 cm - 1.57"

**B.** Depth. Profondeur. Profundidad. 35 cm - 13.78"

**C.** Height. Hauteur. Altura. 40 cm - 15.75"

FINISHES. TRAITS. ACABADOS.

---

Finishes for the bases. Finitions des pieds. Acabados de las patas.

---

Lacquered. Laqué. Lacados.

---



KOKOA

SUMA.

PRICES. PRIX. PRECIOS.

SUMA. Ottomans. Poufs. Ottomans.



**SUMP95BS**

95 x 35 H40  
37.4"x 13.78" H15.75"

Mattress. Matelas. Colchón.  
105 41.34"



**SUMP135BS**

135 x 35 H40  
53.15"x 13.78" H15.75"

Mattress. Matelas. Colchón.  
150 59.06" | 160 62.99"  
153 60.24"

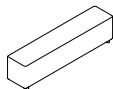

**SUMP165BS**

165 x 35 H40  
64.96"x 13.78" H15.75"

Mattress. Matelas. Colchón.  
180 70.87" | 200 78.74"  
183 72.05" | 193 75.98"

| MEASUREMENT. MESURE. MEDIDA.          | REF.      | M.L. | COM / COL | 1      | 2      | 3      | 4      | 5        | L1       | L2       |
|---------------------------------------|-----------|------|-----------|--------|--------|--------|--------|----------|----------|----------|
| 95 x 35 H40   37.4"x 13.78" H15.75"   | SUMP95BE  | 2    | 611,57    | 619,83 | 644,63 | 661,16 | 706,61 | 776,86   | 793,39   | 867,77   |
| 135 x 35 H40   53.15"x 13.78" H15.75" | SUMP135BE | 2.3  | 710,74    | 723,14 | 752,07 | 776,86 | 830,58 | 925,62   | 946,28   | 1.041,32 |
| 165 x 35 H40   64.96"x 13.78" H15.75" | SUMP165BE | 2.6  | 780,99    | 797,52 | 830,58 | 855,37 | 921,49 | 1.028,93 | 1.053,72 | 1.165,29 |





Designer  
Mario Ruiz

STYLE. ESTILO.  
Essential

FEATURES. TRAITS. CARACTERÍSTICAS.

Sofa bed with removable upholstery. In the leather option, seat and back cushion upholstery is removable.

Wooden frame covered with flexible cold shaped polyurethane foam.

Mechanism with front elevation opening integrated into the frame, built in steel finished in polyester powder coat paint.

Spring mattress, 14 cm thick.

Seat cushion made of different densities of polyurethane foam, padded on the surface with polyester fibre. Back cushions made of different densities of polyurethane foam, padded on the surface with polyester fibre.

Metallic bases coated in manganese colour polyester powder paint. LDPE and felt stops.

Canapé lit avec tapisserie déhoussable. En cuir, coussins d'assise et coussins de dossier déhoussables.

Cadre de lit en bois recouvert de mousse de polyuréthane souple à froid et de fibre de polyester.

Mécanisme de levage intégré au cadre avec ouverture frontale, fabriqué en acier et recouvert de peinture polyester en poudre.

Matelas à ressort de 14 cm d'épaisseur.

Coussins d'assise fabriqués à l'aide de diverses densités de mousse de polyuréthane, avec matelassage extérieur en fibre de polyester. Coussins du dossier fabriqués à l'aide de diverses densités de mousse de polyuréthane, avec matelassage extérieur en fibre de polyester.

Bases métalliques recouvertes de peinture polyester en poudre et finition manganèse, équipées de patins en PEBD et feutre.

Sofá cama con tapicería desenfundable. En la opción de tapizado en piel, los cojines de asiento y respaldo son desenfundables.

Bastidor de madera recubierto de espuma de poliuretano flexible en frío y fibra de poliéster.

Mecanismo integrado en el bastidor con apertura de elevación frontal, construido en acero lacado en pintura de poliéster en polvo.

Colchón de muelles de 14 cm de grosor.

Cojines de asiento fabricados en distintas densidades de espuma poliuretano, acolchado en la superficie con fibra de poliéster. Cojines de respaldo realizados en distintas densidades de espuma poliuretano, acolchado en la superficie con fibra de poliéster.

Bases metálicas recubiertas en pintura de poliéster en polvo color manganeso. Protectores de LDPE y fieltro.

## IVY.

### GENERAL MEASUREMENTS. MESURES GÉNÉRALES. MEDIDAS GENERALES.

---

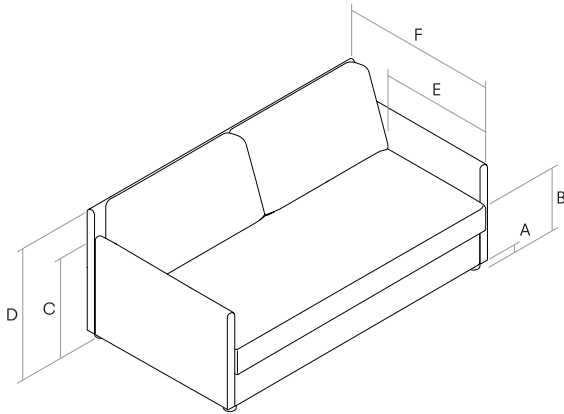

- A.** Base height. Hauteur de base. Altura de base. 5 cm - 1.97"
- B.** Seat height. Hauteur du siège. Altura de asiento. 42 cm - 16.54"
- C.** Arm height. Hauteur des bras. Altura de brazo. 68 cm - 26.77"
- D.** Backrest height. Hauteur du dossier. Altura de respaldo. 90 cm - 35.43"
- E.** Seat depth. Profondeur d'assise. Profundidad de asiento. 65 cm - 25.59"
- F.** Depth. Profondeur. Profundidad. 98 cm - 38.58"

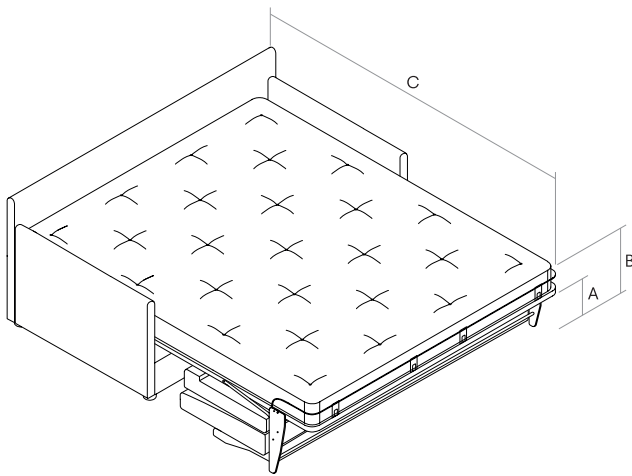

- A.** Base height. Hauteur de base. Altura de base. 40 cm - 15.75"
- B.** Bed height. Hauteur du lit. Altura de cama. 55 cm - 21.65"
- C.** Depth. Profondeur. Profundidad. 215 cm - 84.65"

### FINISHES. TRAITS. ACABADOS.

---

Finishes for the metal feet. Finitions des pieds métalliques. Acabados de las patas metálicas.

---

Polyester powder paint. Peinture polyester en poudre. Pintura poliéster en polvo.

---



Manganese metal.  
Métal manganèse.  
Metal manganeso.

IVY.

PRICES. PRIX. PRECIOS.

IVY. Sofa bed. Canapé lit. Sofá cama.

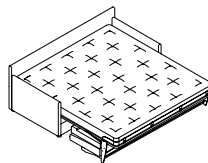
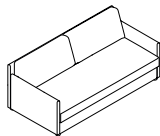
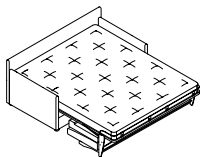
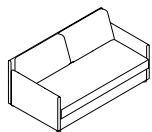

**IVYSC176**

Sofa. Canapé. Sofá.  
176 x 98 H90  
69.29" x 38.58" H35.43"

Bed. Lit. Cama.  
176 x 215 H65  
69.29" x 84.65" H25.59"

Mattress. Matelas. Colchón.  
140 x 197 H14  
55.12" x 77.56" H5.51"

**IVYSC196**

Sofa. Canapé. Sofá.  
196 x 98 H90  
77.17" x 38.58" H35.43"

Bed. Lit. Cama.  
196 x 215 H65  
77.17" x 84.65" H25.59"

Mattress. Matelas. Colchón.  
160 x 197 H14  
62.99" x 77.56" H5.51"

| MEASUREMENT. MESURE. MEDIDA.           | REF.     | M.L. | COM / COL | 1        | 2        | 3        | 4        | 5        | L1       | L2       |
|--|----------|------|-----------|----------|----------|----------|----------|----------|----------|----------|
| 176 x 98 H90   69.29" x 38.58" H35.43" | IVYSC176 | 12.3 | 3.462,81  | 3.566,12 | 3.739,67 | 3.909,09 | 4.247,93 | 4.855,37 | 4.991,74 | 5.603,31 |
| 196 x 98 H90   77.17" x 38.58" H35.43" | IVYSC196 | 12.7 | 3.694,21  | 3.797,52 | 3.971,07 | 4.144,63 | 4.495,87 | 5.115,70 | 5.260,33 | 5.884,30 |



# VENICE.

## SOFA BED. CANAPÉ LIT. SOFÁ CAMA.



Designer  
Mario Ruiz

STYLE. ESTILO.  
New Classic

### FEATURES. TRAITS. CARACTERÍSTICAS.

---

Sofa bed with removable upholstery. In the leather option, seat and back cushion upholstery is removable.

Wooden frame covered with flexible cold shaped polyurethane foam.

Mechanism with front elevation opening integrated into the frame, built in steel finished in polyester powder coat paint.

Spring mattress, 12 cm thick.

Seat cushion made of different densities of polyurethane foam, padded on the surface with polyester fibre. Back cushions stuffed with polyester fibre and washed, sterilised down.

Metallic bases coated in manganese colour polyester powder paint. LDPE and felt stops.

Canapé lit avec tapisserie déhoussable. En cuir, coussins d'assise et coussins de dossier déhoussables.

Cadre de lit en bois recouvert de mousse de polyuréthane souple à froid et de fibre de polyester.

Mécanisme de levage intégré au cadre avec ouverture frontale, fabriqué en acier et recouvert de peinture polyester en poudre.

Matelas à ressort de 12 cm d'épaisseur.

Coussin d'assise fabriqué à l'aide de diverses densités de mousse de polyuréthane, avec matelassage extérieur en fibre de polyester. Coussins du dossier garnis de fibre de polyester et plumes lavées et stérilisées.

Bases métalliques recouvertes de peinture polyester en poudre et finition manganèse, équipées de patins en PEBD et feutre.

Sofá cama con tapicería desenfundable. En la opción de tapizado en piel, los cojines de asiento y respaldo son desenfundables.

Bastidor de madera recubierto de espuma de poliuretano flexible en frío y fibra de poliéster.

Mecanismo integrado en el bastidor con apertura de elevación frontal, construido en acero lacado en pintura de poliéster en polvo.

Colchón de muelles de 12 cm de grosor.

Cojín de asiento fabricado en distintas densidades de espuma poliuretano, acolchado en la superficie con fibra de poliéster. Cojines de respaldo rellenos de fibra de poliéster y pluma lavada y esterilizada.

Bases metálicas recubiertas en pintura de poliéster en polvo color manganeso. Protectores de LDPE y fieltro.



## VENICE.

### GENERAL MEASUREMENTS. MESURES GÉNÉRALES. MEDIDAS GENERALES.

---

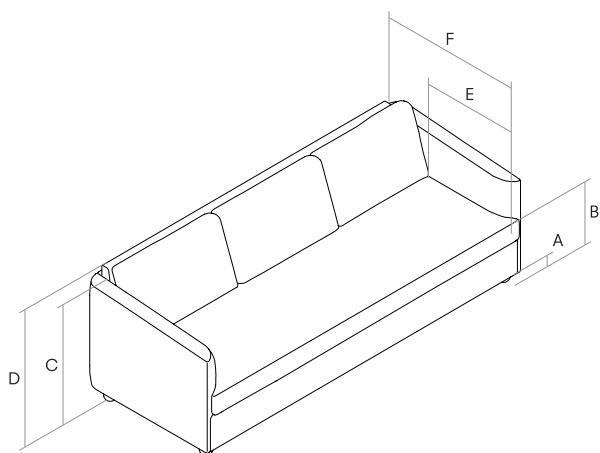

- A.** Base height. Hauteur de base. Altura de base. 20 cm - 7.87"
- B.** Seat height. Hauteur du siège. Altura de asiento. 44 cm - 17.32"
- C.** Arm height. Hauteur des bras. Altura de brazo. 58 cm - 22.83"
- D.** Backrest height. Hauteur du dossier. Altura de respaldo. 75 cm - 29.53"
- E.** Seat depth. Profondeur d'assise. Profundidad de asiento. 65 cm - 25.59"
- F.** Depth. Profondeur. Profundidad. 96 cm - 37.80"

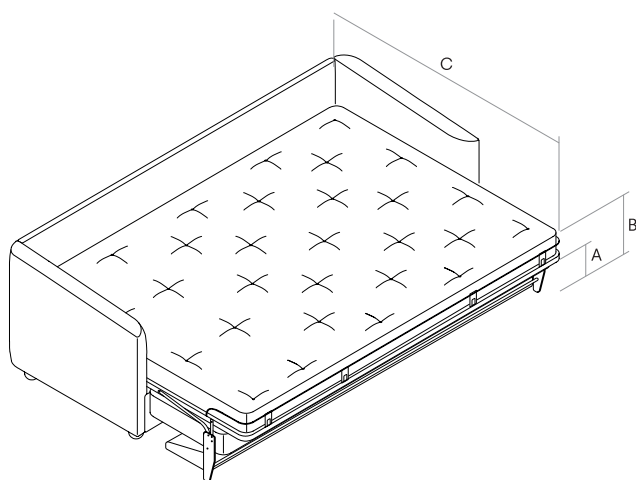

- A.** Base height. Hauteur de base. Altura de base. 40 cm - 15.75"
- B.** Bed height. Hauteur du lit. Altura de cama. 62 cm - 24.41"
- C.** Depth. Profondeur. Profundidad. 98 cm - 38.58"

### FINISHES. TRAITS. ACABADOS.

---

Finishes for the metal feet. Finitions des pieds métalliques. Acabados de las patas metálicas.

---

Polyester powder paint. Peinture polyester en poudre. Pintura poliéster en polvo.

---



Manganese metal.  
Métal manganèse.  
Metal manganeso.

## VENICE.

PRICES. PRIX. PRECIOS.

---

VENICE. Sofa bed. Canapé lit. Sofá cama.

---

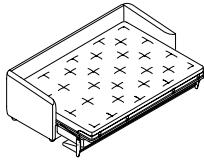
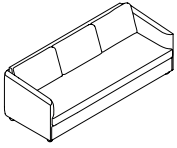

### VENSC232

Sofa. Canapé. Sofá.

232 x 94 H80

91.34"x 37.01" H31.5"

Bed. Lit. Cama.

232 x 178 H62

91.34"x 70.08" H24.41"

Mattress. Matelas. Colchón.

160 x 190 H12

62.99"x 74.8 H4.72"

| MEASUREMENT. MESURE. MEDIDA. REF.             | M.L. | COM / COL | 1        | 2        | 3        | 4        | 5        | L1       | L2       |
|---|------|-----------|----------|----------|----------|----------|----------|----------|----------|
| 232 x 94 H80   91.34" x 37.01" H31.5" VENS232 | 12   | 4.776,86  | 4.871,90 | 5.037,19 | 5.206,61 | 5.541,32 | 6.140,50 | 6.272,73 | 6.871,90 |



# AXIS.

# TABLE. MESA.



Designer  
Mario Ruiz

STYLE. ESTILO.  
Singular

## FEATURES. TRAITS. CARACTERÍSTICAS.

---

Available options for the top:  
American walnut, dark stained oak,  
natural oak, black oak or natural stone  
in 3 finishes to choose.

Metal legs and structure coated with  
polyester powder manganese paint.  
LDPE stops.

Wood profiles upholstered in leather.

Options disponibles pour le plateau:  
Placage de noyer américain, chêne  
teint, chêne naturel, chêne noir ou  
pierre naturelle en 3 finitions au choix.

Pieds et structure métalliques avec  
un revêtement de peinture polyester  
en poudre finition manganèse. Patins  
en PEBD.

Profils en bois tapissée en cuir.

Opciones disponibles para el sobre:  
Chapado en nogal americano, roble  
teñido oscuro, roble natural, roble  
negro o piedra natural en 3 acabados  
a elegir.

Estructura y patas metálicas  
recubiertas con pintura poliéster en  
polvo acabado manganeso. Topes  
en LDPE.

Perfiles de madera tapizados en piel.

AXIS.

GENERAL MEASUREMENTS. MESURES GÉNÉRALES. MEDIDAS GENERALES.

---

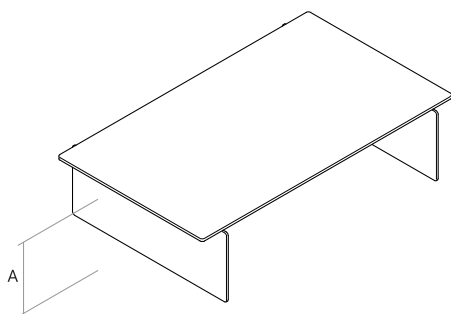

A. Height. Hauteur. Altura. 33 cm - 12.99"

FINISHES. TRAITS. ACABADOS.

---

Finishes for the metal bases. Finitions des bases métalliques. Acabados de las bases metálicas.

---

Polyester powder paint. Peinture polyester en poudre. Pintura poliéster en polvo.

---



Manganese metal.  
Métal manganèse.  
Metal manganeso.

Finishes for the top. Finitions pour le plateau. Acabados para el sobre.

---

Wood finishes. Finitions bois. Acabado de la madera.

---



**RN**  
Natural oak.  
Chêne naturel.  
Roble natural.



**NA**  
Natural american walnut.  
Noyer américain.  
Nogal americano.



**RT**  
Dark stained oak.  
Chêne teint foncée.  
Roble teñido oscuro.



**RL**  
Oak painted in black with open-pore finish.  
Chêne laqué noir à pores ouverts.  
Roble lacado negro por abierto.

Natural stone colours. Couleurs pierre naturelle. Colores piedra natural.

---



CARRARA



MARQUINA



EMPERADOR

Leather. Cuir. Piel.

---



NUVOLA  
199



NUVOLA  
163



ELMOBALTIQUE  
88042



NUVOLA  
155



NUVOLA  
151



NUVOLA  
147



ELMOBALTIQUE  
33280



ELMOBALTIQUE  
43003



ELMOBALTIQUE  
99011

AXIS.

PRICES. PRIX. PRECIOS.

AXIS. Coffe table. Table basse. Mesa baja.



**AXICRT75X35**

74 x 35 H33  
29.13" x 13.78" H12.99"

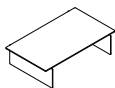

**AXICRT130X75**

130 x 75 H33  
51.18" x 29.53" H12.99"

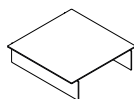

**AXICRT120X120**

120 x 120 H33  
47.24" x 47.24" H12.99"

| MEASUREMENT. MESURE. MEDIDA.            | FINISHES. TRAITS. ACABADOS.   | REF.            | PRICE. PRIX. PRECIO. |
|---|---|-----------------|----------------------|
| 75 x 35 H33   29.13" x 13.78" H12.99"   | Natural oak. Chêne naturel. Roble natural.  | AXICRT75X35RN   | 1.169,42             |
| 75 x 35 H33   29.13" x 13.78" H12.99"   | American walnut. Noyer américain. Nogal americano.  | AXICRT75X35NA   | 1.185,95             |
| 75 x 35 H33   29.13" x 13.78" H12.99"   | Dark stained oak. Chêne teinté foncé. Roble teñido oscuro.  | AXICRT75X35RT   | 1.169,42             |
| 75 x 35 H33   29.13" x 13.78" H12.99"   | Oak painted in black with open-pore finish. Chêne laqué noir à pores ouverts. Roble lacado negro por abierto. | AXICRT75X35RL   | 1.185,95             |
| 75 x 35 H33   29.13" x 13.78" H12.99"   | Natural stone. Pierre naturelle. Piedra Natural.  | AXICRT75X35PN   | 1.210,74             |
| 130 x 75 H33   51.18" x 29.53" H12.99"  | Natural oak. Chêne naturel. Roble natural.  | AXICRT130X75RN  | 1.599,17             |
| 130 x 75 H33   51.18" x 29.53" H12.99"  | American walnut. Noyer américain. Nogal americano.  | AXICRT130X75NA  | 1.623,97             |
| 130 x 75 H33   51.18" x 29.53" H12.99"  | Dark stained oak. Chêne teinté foncé. Roble teñido oscuro.  | AXICRT130X75RT  | 1.599,17             |
| 130 x 75 H33   51.18" x 29.53" H12.99"  | Oak painted in black with open-pore finish. Chêne laqué noir à pores ouverts. Roble lacado negro por abierto. | AXICRT130X75RL  | 1.623,97             |
| 130 x 75 H33   51.18" x 29.53" H12.99"  | Natural stone. Pierre naturelle. Piedra Natural.  | AXICRT130X75PN  | 1.921,49             |
| 120 x 120 H33   47.24" x 47.24" H12.99" | Natural oak. Chêne naturel. Roble natural.  | AXICRT120X120RN | 2.268,60             |
| 120 x 120 H33   47.24" x 47.24" H12.99" | American walnut. Noyer américain. Nogal americano.  | AXICRT120X120NA | 2.351,24             |
| 120 x 120 H33   47.24" x 47.24" H12.99" | Dark stained oak. Chêne teinté foncé. Roble teñido oscuro.  | AXICRT120X120RT | 2.268,60             |
| 120 x 120 H33   47.24" x 47.24" H12.99" | Oak painted in black with open-pore finish. Chêne laqué noir à pores ouverts. Roble lacado negro por abierto. | AXICRT120X120RL | 2.351,24             |
| 120 x 120 H33   47.24" x 47.24" H12.99" | Natural stone. Pierre naturelle. Piedra Natural.  | AXICRT120X120PN | 2.524,79             |



# MIKA.

## BEDSIDE TABLE. TABLE DE CHEVET. MESITA DE NOCHE.



Designer  
Mario Ruiz

STYLE. ESTILO.  
Essential

### FEATURES. TRAITS. CARACTERÍSTICAS.

---

Bedside table with top covered in leather or Dekton® in 3 finishes to choose.

Wooden structure. Finishes in American walnut, natural oak, dark stained oak, black oak or lacquered in different colours.

Bases in MDF, KOKOA lacquered. LDPE and felt stops.

Table de chevet avec plateau recouvert de cuir ou Dekton® en 3 finitions au choix.

Structure en bois. Finitions en noyer américain, chêne naturel, chêne teinté foncé, chêne noir ou laqué de différentes couleurs.

Bases en MDF laquée couleur KOKOA. Patins en PEBD et feutre.

Mesita de noche con sobre recubierto en piel o Dekton® en 3 acabados a elegir.

Estructura fabricada en madera en acabados nogal americano, roble natural, roble teñido oscuro, roble negro o lacada en distintos colores.

Bases fabricadas en MDF lacadas en color KOKOA. Protectores de LDPE y fieltro.



MIKA.

GENERAL MEASUREMENTS. MESURES GÉNÉRALES. MEDIDAS GENERALES.

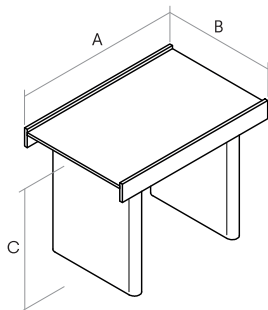

- A. Width. Largeur. Ancho. 55 cm - 21.65"
- B. Depth. Profondeur. Profundidad. 37 cm - 14.57"
- C. Height. Hauteur. Altura. 42 cm - 16.54"

FINISHES. TRAITS. ACABADOS.

Finishes for the bases. Finitions des bases. Acabados de las bases.

Lacquered. Laqué. Lacados.



KOKOA

Finishes for the top. Finitions pour le plateau. Acabados para el sobre.

Wood finishes. Finitions bois. Acabado de la madera.

Dekton® colours. Couleurs Dekton®. Colores Dekton®.



**RN**  
Natural oak.  
Chêne naturel.  
Roble natural.



**NA**  
Natural american walnut.  
Noyer américain.  
Nogal americano.



**RT**  
Dark stained oak.  
Chêne teint foncée.  
Roble teñido oscuro.



**RL**  
Oak painted in black with open-pore finish.  
Chêne laqué noir à pores ouverts.  
Roble lacado negro por abierto.



REM



KELYA



KIRA

Lacquered. Laqué. Lacados.



SEDA



ALOE



KHAKI



BRICK



RUBI



KOKOA

Leather. Cuir. Piel.



NUVOLA  
199



NUVOLA  
163



ELMOBALTIQUE  
88042



NUVOLA  
155



NUVOLA  
151



NUVOLA  
147



ELMOBALTIQUE  
33280



ELMOBALTIQUE  
43003



ELMOBALTIQUE  
99011

MIKA.

PRICES. PRIX. PRECIOS.

MIKA. Bedside table. Table de chevet. Mesita de noche.



**MIKBT55LE**

55 x 37 H42  
21.65" x 14.57" H16.54"

Leather interior surface.  
Surface intérieure en cuir.  
Superficie interior en piel.



**MIKBT55DK**

55 x 37 H42  
21.65" x 14.57" H16.54"

Dekton® interior surface.  
Surface intérieure en Dekton®.  
Superficie interior en Dekton®.

| MEASUREMENT. MESURE. MEDIDA.      | FINISHES. TRAITS. ACABADOS.   | REF.        | PRICE. PRIX. PRECIO. |
|-----------------------------------|---|-------------|----------------------|
| 55 x 37 H42   21.65x 14.57 H16.54 | Natural oak. Chêne naturel. Roble natural.  | MIKBT55LERN | 1.000,00             |
| 55 x 37 H42   21.65x 14.57 H16.54 | American walnut. Noyer américain. Nogal americano.  | MIKBT55LENA | 1.008,26             |
| 55 x 37 H42   21.65x 14.57 H16.54 | Dark stained oak. Chêne teinté foncé. Roble teñido oscuro.  | MIKBT55LERT | 1.000,00             |
| 55 x 37 H42   21.65x 14.57 H16.54 | Oak painted in black with open-pore finish. Chêne laqué noir à pores ouverts. Roble lacado negro por abierto. | MIKBT55LERL | 1.008,26             |
| 55 x 37 H42   21.65x 14.57 H16.54 | Matt lacquer. Laque mate. Lacado mate.  | MIKBT55LELA | 909,09               |
| 55 x 37 H42   21.65x 14.57 H16.54 | Natural oak. Chêne naturel. Roble natural.  | MIKBT55DKRN | 913,22               |
| 55 x 37 H42   21.65x 14.57 H16.54 | American walnut. Noyer américain. Nogal americano.  | MIKBT55DKNA | 925,62               |
| 55 x 37 H42   21.65x 14.57 H16.54 | Dark stained oak. Chêne teinté foncé. Roble teñido oscuro.  | MIKBT55DKRT | 913,22               |
| 55 x 37 H42   21.65x 14.57 H16.54 | Oak painted in black with open-pore finish. Chêne laqué noir à pores ouverts. Roble lacado negro por abierto. | MIKBT55DKRL | 925,62               |
| 55 x 37 H42   21.65x 14.57 H16.54 | Matt lacquer. Laque mate. Lacado mate.  | MIKBT55DKLA | 826,45               |



# SACHA SE.

# TABLE. MESA.



Designer  
Mario Ruiz

STYLE. ESTILO.  
Essential

## FEATURES. TRAITS. CARACTERÍSTICAS.

---

Available options for the top:  
American walnut, dark stained oak,  
black oak, natural oak wood veneer,  
or Dekton® in 3 finishes to choose.

Top base of MDF, KOKOA lacquered.

Central supports in MDF, KOKOA  
lacquered.

Available options for the inferior  
shelf: American walnut, dark stained  
oak, black oak, or natural oak wood  
veneer.

Metallic bases covered in  
manganese-finish polyester powder  
paint with LDPE stops.

Options disponibles pour le plateau:  
Placage de noyer américain, chêne  
teint, chêne noir, chêne naturel ou  
Dekton® en 3 finitions au choix.

Base du plateau en MDF aquee  
couleur KOKOA.

Supports centraux: MDF laquée  
couleur KOKOA.

Options disponibles pour l'étagère  
inférieure: Placage de noyer  
américain, chêne teint, chêne noir ou  
chêne naturel.

Bases métalliques recouvertes de  
peinture polyester en poudre couleur  
manganèse, équipées de patins en  
PEBD.

Opciones disponibles para el sobre:  
Chapado en nogal americano, roble  
teñido oscuro, roble negro, roble  
natural o Dekton® en 3 acabados a  
elegir.

Base del sobre en MDF lacada en  
color KOKOA.

Soportes centrales: MDF lacados en  
color KOKOA.

Opciones para el sobre inferior:  
Chapado en nogal americano, roble  
teñido oscuro, roble negro o roble  
natural, lacado en diferentes colores.

Bases metálicas recubiertas en  
pintura poliéster en polvo acabado  
manganeso con topes de LDPE.

## SACHA SE.

### GENERAL MEASUREMENTS. MESURES GÉNÉRALES. MEDIDAS GENERALES.

---

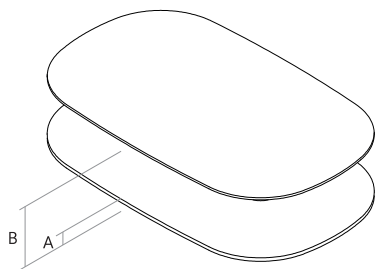

**A.** Base height. Hauteur de base. Altura de base. 4 cm - 1.57"

**B.** Height. Hauteur. Altura. 33 cm - 12.99"

### FINISHES. TRAITS. ACABADOS.

---

Finishes for the metal bases. Finitions des bases métalliques. Acabados de las bases metálicas.

---

Polyester powder paint. Peinture polyester en poudre. Pintura poliéster en polvo.

---



Manganese metal.  
Métal manganèse.  
Metal manganeso.

Finishes for the top. Finitions pour le plateau. Acabados para el sobre.

---

Wood finishes. Finitions bois. Acabado de la madera.

---



**RN**  
Natural oak.  
Chêne naturel.  
Roble natural.



**NA**  
Natural american walnut.  
Noyer américain.  
Nogal americano.



**RT**  
Dark stained oak.  
Chêne teint foncée.  
Roble teñido oscuro.



**RL**  
Oak painted in black with open-pore finish.  
Chêne laqué noir à pores ouverts.  
Roble lacado negro por abierto.

Lacquered. Laqué. Lacados.

---



SEDA



ALOE



KHAKI



BRICK



RUBI



KOKOA

Dekton® colours. Couleurs Dekton®. Colores Dekton®.

---



REM



KELYA



KIRA

## SACHA SE.

PRICES. PRIX. PRECIOS.

SACHA SE. Task Table. Table Task. Mesa Task.

Finishes for the top. Finitions pour le plateau. Acabados para el sobre.



### SACSETTOP

61.5 x 61.5 H42  
24.21"x 24.21" H16.54"

Superellipse top.  
Plateau superellipse.  
Sobre superellipse.

| MEASUREMENT. MESURE. MEDIDA.          | FINISHES. TRAITS. ACABADOS.   | REF.        | PRICE. PRIX. PRECIO. |
|---------------------------------------|---|-------------|----------------------|
| 61.5 x 61.5 H42   24.21x 24.21 H16.54 | Natural oak. Chêne naturel. Roble natural.  | SACSETTOPRN | 314,05               |
| 61.5 x 61.5 H42   24.21x 24.21 H16.55 | American walnut. Noyer américain. Nogal americano.  | SACSETTOPNA | 314,05               |
| 61.5 x 61.5 H42   24.21x 24.21 H16.56 | Dark stained oak. Chêne teinté foncé. Roble teñido oscuro.  | SACSETTOPRT | 314,05               |
| 61.5 x 61.5 H42   24.21x 24.21 H16.57 | Oak painted in black with open-pore finish. Chêne laqué noir à pores ouverts. Roble lacado negro por abierto. | SACSETTOPRL | 314,05               |
| 61.5 x 61.5 H42   24.21x 24.21 H16.58 | Matt lacquer. Laque mate. Lacado mate.  | SACSETTOPLA | 235,54               |
| 61.5 x 61.5 H42   24.21x 24.21 H16.59 | Dektor®   | SACSETTOPDK | 657,02               |

Finishes for the base. Finitions de la base. Acabados para la base.



### SACSETBAS

61.5 x 61.5 H42  
24.21"x 24.21" H16.54"

Superellipse base.  
Base superellipse.  
Base superellipse.

| MEASUREMENT. MESURE. MEDIDA.          | FINISHES. TRAITS. ACABADOS.   | REF.        | PRICE. PRIX. PRECIO. |
|---------------------------------------|---|-------------|----------------------|
| 61.5 x 61.5 H42   24.21x 24.21 H16.54 | Natural oak. Chêne naturel. Roble natural.  | SACSETBASRN | 1.252,07             |
| 61.5 x 61.5 H42   24.21x 24.21 H16.55 | American walnut. Noyer américain. Nogal americano.  | SACSETBASNA | 1.376,03             |
| 61.5 x 61.5 H42   24.21x 24.21 H16.56 | Dark stained oak. Chêne teinté foncé. Roble teñido oscuro.  | SACSETBASRT | 1.252,07             |
| 61.5 x 61.5 H42   24.21x 24.21 H16.57 | Oak painted in black with open-pore finish. Chêne laqué noir à pores ouverts. Roble lacado negro por abierto. | SACSETBASRL | 1.376,03             |
| 61.5 x 61.5 H42   24.21x 24.21 H16.58 | Matt lacquer. Laque mate. Lacado mate.  | SACSETBASLA | 1.128,10             |

## SACHA SE.

### PRICES. PRIX. PRECIOS.

SACHA SE. Coffe Table. Table café. Mesa café.

Finishes for the top. Finitions pour le plateau. Acabados para el sobre.

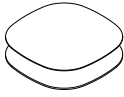

#### SACSECTOP1

140 x 140 H33  
55.12"x 55.12" H12.99"

Superellipse top.  
Plateau superellipse.  
Sobre superellipse.

| MEASUREMENT. MESURE. MEDIDA.            | FINISHES. TRAITS. ACABADOS.   | REF.         | PRICE. PRIX. PRECIO. |
|---|---|--------------|----------------------|
| 140 x 140 H33   55.12" x 55.12" H12.99" | Natural oak. Chêne naturel. Roble natural.  | SACSECTOP1RN | 1.028,93             |
| 140 x 140 H33   55.12" x 55.12" H12.99" | American walnut. Noyer américain. Nogal americano.  | SACSECTOP1NA | 1.119,83             |
| 140 x 140 H33   55.12" x 55.12" H12.99" | Dark stained oak. Chêne teinté foncé. Roble teñido oscuro.  | SACSECTOP1RT | 1.028,93             |
| 140 x 140 H33   55.12" x 55.12" H12.99" | Oak painted in black with open-pore finish. Chêne laqué noir à pores ouverts. Roble lacado negro por abierto. | SACSECTOP1RL | 1.119,83             |
| 140 x 140 H33   55.12" x 55.12" H12.99" | Matt lacquer. Laque mate. Lacado mate.  | SACSECTOP1LA | 925,62               |
| 140 x 140 H33   55.12" x 55.12" H12.99" | Dekton®   | SACSECTOP1DK | 1.859,50             |

Finishes for the base. Finitions de la base. Acabados para la base.

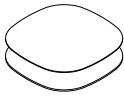

#### SACSECBAS1

140 x 140 H33  
55.12"x 55.12" H12.99"

Superellipse base.  
Base superellipse.  
Base superellipse.

| MEASUREMENT. MESURE. MEDIDA.            | FINISHES. TRAITS. ACABADOS.   | REF.         | PRICE. PRIX. PRECIO. |
|---|---|--------------|----------------------|
| 140 x 140 H33   55.12" x 55.12" H12.99" | Natural oak. Chêne naturel. Roble natural.  | SACSECBAS1RN | 3.392,56             |
| 140 x 140 H33   55.12" x 55.12" H12.99" | American walnut. Noyer américain. Nogal americano.  | SACSECBAS1NA | 3.690,08             |
| 140 x 140 H33   55.12" x 55.12" H12.99" | Dark stained oak. Chêne teinté foncé. Roble teñido oscuro.  | SACSECBAS1RT | 3.392,56             |
| 140 x 140 H33   55.12" x 55.12" H12.99" | Oak painted in black with open-pore finish. Chêne laqué noir à pores ouverts. Roble lacado negro por abierto. | SACSECBAS1RL | 3.690,08             |
| 140 x 140 H33   55.12" x 55.12" H12.99" | Matt lacquer. Laque mate. Lacado mate.  | SACSECBAS1LA | 2.719,01             |

## SACHA SE.

PRICES. PRIX. PRECIOS.

SACHA SE. Coffe Table. Table café. Mesa café.

Finishes for the top. Finitions pour le plateau. Acabados para el sobre.



### SACSECTOP2

140 x 85 H33  
55.12" x 33.46" H12.99"

Superellipse rectangular top.  
Plateau superellipse rectangolaire.  
Sobre superelipse rectangular.

| MEASUREMENT. MESURE. MEDIDA.           | FINISHES. TRAITS. ACABADOS.   | REF.         | PRICE. PRIX. PRECIO. |
|--|---|--------------|----------------------|
| 140 x 85 H33   55.12" x 33.46" H12.99" | Natural oak. Chêne naturel. Roble natural.  | SACSECTOP2RN | 694,21               |
| 140 x 85 H33   55.12" x 33.46" H12.99" | American walnut. Noyer américain. Nogal americano.  | SACSECTOP2NA | 739,67               |
| 140 x 85 H33   55.12" x 33.46" H12.99" | Dark stained oak. Chêne teinté foncé. Roble teñido oscuro.  | SACSECTOP2RT | 694,21               |
| 140 x 85 H33   55.12" x 33.46" H12.99" | Oak painted in black with open-pore finish. Chêne laqué noir à pores ouverts. Roble lacado negro por abierto. | SACSECTOP2RL | 739,67               |
| 140 x 85 H33   55.12" x 33.46" H12.99" | Matt lacquer. Laque mate. Lacado mate.  | SACSECTOP2LA | 677,69               |
| 140 x 85 H33   55.12" x 33.46" H12.99" | Dektor®   | SACSECTOP2DK | 1.330,58             |

Finishes for the base. Finitions de la base. Acabados para la base.



### SACSECBAS2

140 x 85 H33  
55.12" x 33.46" H12.99"

Superellipse rectangular base.  
Base superelipse rectangolaire.  
Base superelipse rectangular.

| MEASUREMENT. MESURE. MEDIDA.           | FINISHES. TRAITS. ACABADOS.   | REF.         | PRICE. PRIX. PRECIO. |
|--|---|--------------|----------------------|
| 140 x 85 H33   55.12" x 33.46" H12.99" | Natural oak. Chêne naturel. Roble natural.  | SACSECBAS2RN | 2.851,24             |
| 140 x 85 H33   55.12" x 33.46" H12.99" | American walnut. Noyer américain. Nogal americano.  | SACSECBAS2NA | 3.115,70             |
| 140 x 85 H33   55.12" x 33.46" H12.99" | Dark stained oak. Chêne teinté foncé. Roble teñido oscuro.  | SACSECBAS2RT | 2.851,24             |
| 140 x 85 H33   55.12" x 33.46" H12.99" | Oak painted in black with open-pore finish. Chêne laqué noir à pores ouverts. Roble lacado negro por abierto. | SACSECBAS2RL | 3.115,70             |
| 140 x 85 H33   55.12" x 33.46" H12.99" | Matt lacquer. Laque mate. Lacado mate.  | SACSECBAS2LA | 1.921,49             |



## SACHA SE.

### PRICES. PRIX. PRECIOS.

SACHA SE. Coffe Table. Table café. Mesa café.

Finishes for the top. Finitions pour le plateau. Acabados para el sobre.



#### SACSECTOP3

180 x 85 H33

70.87" x 53.46" H12.99"

Superellipse rectangular top.

Plateau superellipse rectangolaire.

Sobre superellipse rectangular.

| MEASUREMENT. MESURE. MEDIDA.        | FINISHES. TRAITS. ACABADOS.   | REF.         | PRICE. PRIX. PRECIO. |
|-------------------------------------|---|--------------|----------------------|
| 180 x 85 H33   70.87 x 33.46 H12.99 | Natural oak. Chêne naturel. Roble natural.  | SACSECTOP3RN | 855,37               |
| 180 x 85 H33   70.87 x 33.46 H12.99 | American walnut. Noyer américain. Nogal americano.  | SACSECTOP3NA | 913,22               |
| 180 x 85 H33   70.87 x 33.46 H12.99 | Dark stained oak. Chêne teinté foncé. Roble teñido oscuro.  | SACSECTOP3RT | 855,37               |
| 180 x 85 H33   70.87 x 33.46 H12.99 | Oak painted in black with open-pore finish. Chêne laqué noir à pores ouverts. Roble lacado negro por abierto. | SACSECTOP3RL | 913,22               |
| 180 x 85 H33   70.87 x 33.46 H12.99 | Matt lacquer. Laque mate. Lacado mate.  | SACSECTOP3LA | 826,45               |
| 180 x 85 H33   70.87 x 33.46 H12.99 | Dekton®   | SACSECTOP3DK | 1.623,97             |

Finishes for the base. Finitions de la base. Acabados para la base.



#### SACSECBAS3

180 x 85 H33

70.87" x 33.46" H12.99"

Superellipse rectangular base.

Base superellipse rectangolaire.

Base superellipse rectangular.

| MEASUREMENT. MESURE. MEDIDA.        | FINISHES. TRAITS. ACABADOS.   | REF.         | PRICE. PRIX. PRECIO. |
|-------------------------------------|---|--------------|----------------------|
| 180 x 85 H33   70.87 x 33.46 H12.99 | Natural oak. Chêne naturel. Roble natural.  | SACSECBAS3RN | 3.231,40             |
| 180 x 85 H33   70.87 x 33.46 H12.99 | American walnut. Noyer américain. Nogal americano.  | SACSECBAS3NA | 3.541,32             |
| 180 x 85 H33   70.87 x 33.46 H12.99 | Dark stained oak. Chêne teinté foncé. Roble teñido oscuro.  | SACSECBAS3RT | 3.231,40             |
| 180 x 85 H33   70.87 x 33.46 H12.99 | Oak painted in black with open-pore finish. Chêne laqué noir à pores ouverts. Roble lacado negro por abierto. | SACSECBAS3RL | 3.541,32             |
| 180 x 85 H33   70.87 x 33.46 H12.99 | Matt lacquer. Laque mate. Lacado mate.  | SACSECBAS3LA | 2.190,08             |



Designer  
Mario Ruiz

STYLE. ESTILO.  
Essential

## FEATURES. TRAITS. CARACTERÍSTICAS.

---

Available options for the top:  
American walnut, dark stained oak,  
black oak, or natural oak wood  
vener.

Central supports in MDF, KOKOA  
lacquered.

Available options for the inferior  
shelf: American walnut, dark stained  
oak, black oak, or natural oak wood  
vener.

Metallic bases covered in  
manganese-finish polyester powder  
paint with LDPE stops.

Options disponibles pour le plateau:  
Placage de noyer américain, chêne  
teint, chêne noir ou chêne naturel.

Supports centraux: MDF laquée  
couleur KOKOA.

Options disponibles pour l'étagère  
inférieure: Placage de noyer  
américain, chêne teint, chêne noir ou  
chêne naturel.

Bases métalliques recouvertes de  
peinture polyester en poudre couleur  
manganèse, équipées de patins en  
PEBD.

Opciones disponibles para el sobre:  
Chapado en nogal americano, roble  
teñido oscuro, roble negro o roble  
natural.

Soportes centrales: MDF lacados en  
color KOKOA.

Opciones para el sobre inferior:  
Chapado en nogal americano, roble  
teñido oscuro, roble negro o roble  
natural.

Bases metálicas recubiertas en  
pintura poliéster en polvo acabado  
manganese con topes de LDPE.

## SACHA SQ.

### GENERAL MEASUREMENTS. MESURES GÉNÉRALES. MEDIDAS GENERALES.

---

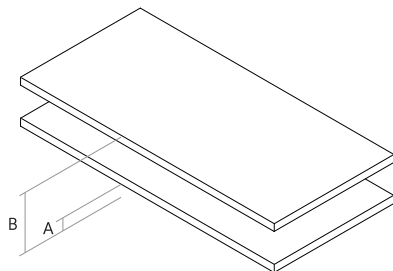

**A.** Base height. Hauteur de base. Altura de base. 4 cm - 1.57"

**B.** Height. Hauteur. Altura. 33 cm - 12.99"

### FINISHES. TRAITS. ACABADOS.

---

Finishes for the metal bases. Finitions des bases métalliques. Acabados de las bases metálicas.

---

Polyester powder paint. Peinture polyester en poudre. Pintura poliéster en polvo.

---



Manganese metal.  
Métal manganèse.  
Metal manganeso.

Finishes for the top. Finitions pour le plateau. Acabados para el sobre.

---

Wood finishes. Finitions bois. Acabado de la madera.

---



**RN**  
Natural oak.  
Chêne naturel.  
Roble natural.



**NA**  
Natural american walnut.  
Noyer américain.  
Nogal americano.



**RT**  
Dark stained oak.  
Chêne teint foncée.  
Roble teñido oscuro.



**RL**  
Oak painted in black with open-pore finish.  
Chêne laqué noir à pores ouverts.  
Roble lacado negro por abierto.

Lacquered. Laqué. Lacados.

---



SEDA



ALOE



KHAKI



BRICK



RUBI



KOKOA

## SACHA SQ.

PRICES. PRIX. PRECIOS.

---

SACHA SQ. Task Table. Table Task. Mesa Task.

---



### SACSQT

61.5 x 61.5 H42  
24.21" x 24.21" H16.54"

Square top. Square base.  
Plateau carré. Base carrée.  
Sobre cuadrado. Base cuadrada.

| MEASUREMENT. MESURE. MEDIDA.           | FINISHES. TRAITS. ACABADOS.   | REF.     | PRICE. PRIX. PRECIO. |
|--|---|----------|----------------------|
| 61.5 x 61.5 H42   24.21 x 24.21 H16.59 | Natural oak. Chêne naturel. Roble natural.  | SACSQTRN | 1.384,30             |
| 61.5 x 61.5 H42   24.21 x 24.21 H16.60 | American walnut. Noyer américain. Nogal americano.  | SACSQTNA | 1.491,74             |
| 61.5 x 61.5 H42   24.21 x 24.21 H16.61 | Dark stained oak. Chêne teinté foncé. Roble teñido oscuro.  | SACSQTRT | 1.384,30             |
| 61.5 x 61.5 H42   24.21 x 24.21 H16.62 | Oak painted in black with open-pore finish. Chêne laqué noir à pores ouverts. Roble lacado negro por abierto. | SACSQTRL | 1.491,74             |
| 61.5 x 61.5 H42   24.21 x 24.21 H16.63 | Matt lacquer. Laque mate. Lacado mate.  | SACSQTLA | 1.173,55             |

SACHA SE. Coffe Table. Table café. Mesa café.

---

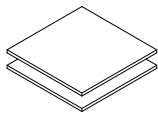

### SACSQC1

140 x 140 H33  
55.12" x 55.12" H12.99"

Square top. Square base.  
Plateau carré. Base carrée.  
Sobre cuadrado. Base cuadrada.

| MEASUREMENT. MESURE. MEDIDA.            | FINISHES. TRAITS. ACABADOS.   | REF.      | PRICE. PRIX. PRECIO. |
|---|---|-----------|----------------------|
| 140 x 140 H33   55.12" x 55.12" H12.99" | Natural oak. Chêne naturel. Roble natural.  | SACSQC1RN | 3.487,60             |
| 140 x 140 H33   55.12" x 55.12" H12.99" | American walnut. Noyer américain. Nogal americano.  | SACSQC1NA | 3.834,71             |
| 140 x 140 H33   55.12" x 55.12" H12.99" | Dark stained oak. Chêne teinté foncé. Roble teñido oscuro.  | SACSQC1RT | 3.487,60             |
| 140 x 140 H33   55.12" x 55.12" H12.99" | Oak painted in black with open-pore finish. Chêne laqué noir à pores ouverts. Roble lacado negro por abierto. | SACSQC1RL | 3.834,71             |
| 140 x 140 H33   55.12" x 55.12" H12.99" | Matt lacquer. Laque mate. Lacado mate.  | SACSQC1LA | 2.789,26             |

## SACHA SQ.

PRICES. PRIX. PRECIOS.

---

SACHA SE. Coffe Table. Table café. Mesa café.

---

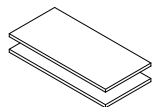

### SACSQC3

180 x 85 H33

70.87" x 33.46" H12.99"

Rectangular top. Rectangular base.

Plateau rectangolaire. Base rectangolaire.

Sobre rectangular. Base rectangular.

| MEASUREMENT. MESURE. MEDIDA.        | FINISHES. TRAITS. ACABADOS.   | REF.      | PRICE. PRIX. PRECIO. |
|-------------------------------------|---|-----------|----------------------|
| 180 x 85 H33   70.87 x 33.46 H12.99 | Natural oak. Chêne naturel. Roble natural.  | SACSQC3RN | 3.276,86             |
| 180 x 85 H33   70.87 x 33.46 H12.99 | American walnut. Noyer américain. Nogal americano.  | SACSQC3NA | 3.603,31             |
| 180 x 85 H33   70.87 x 33.46 H12.99 | Dark stained oak. Chêne teinté foncé. Roble teñido oscuro.  | SACSQC3RT | 3.276,86             |
| 180 x 85 H33   70.87 x 33.46 H12.99 | Oak painted in black with open-pore finish. Chêne laqué noir à pores ouverts. Roble lacado negro por abierto. | SACSQC3RL | 3.603,31             |
| 180 x 85 H33   70.87 x 33.46 H12.99 | Matt lacquer. Laque mate. Lacado mate.  | SACSQC3LA | 2.314,05             |

# TAB.

# TABLE. MESA.



Designer  
Mario Ruiz

STYLE. ESTILO.  
Essential

VERSION. VERSIÓN.  
Coffee. Café.

## FEATURES. TRAITS. CARACTERÍSTICAS.

---

Available options for the top:  
American walnut, dark stained oak,  
dark oak or natural oak wood veneer,  
lacquered in different colours,  
upholstered in leather or Dekton® in 3  
finishes to choose.

Top base of MDF, KOKOA lacquered.

Available options for the base: cross-  
shaped or flat superellipse-shaped  
metal base coated with polyester  
powder manganese paint.

LPDE and felt stops.

Options disponibles pour le plateau:  
Placage de noyer américain, chêne  
teint, chêne noir ou chêne naturel,  
laqué de différentes couleurs,  
rembourré en cuir ou Dekton® en 3  
finitions au choix.

Base du plateau en MDF laquée  
couleur KOKOA.

Options disponibles pour la base:  
base métallique en forme de croix  
ou de superellipse plat avec un  
revêtement de peinture polyester en  
poudre finition manganèse.

Patins en PEBD et feutre.

Opciones disponibles para el sobre:  
Chapado en nogal americano, roble  
teñido oscuro, roble negro o roble  
natural, lacado en diferentes colores,  
tapizado en piel o Dekton® en 3  
acabados a elegir.

Base del sobre en DM lacadas en  
color KOKOA.

Opciones para la base: base metálica  
en forma de cruz o en forma de  
superelipse plana revestida con  
pintura poliéster en polvo acabado  
manganeso.

Protectores de LDPE y fieltro.

TAB.

GENERAL MEASUREMENTS. MESURES GÉNÉRALES. MEDIDAS GENERALES.

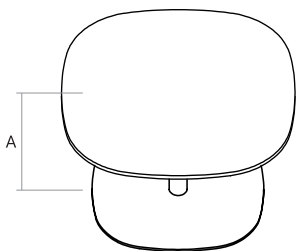

A. Height. Hauteur. Altura. 46.5 cm - 18.31"

FINISHES. TRAITS. ACABADOS.

Finishes for the metal bases. Finitions des bases métalliques. Acabados de las bases metálicas.

Polyester powder paint. Peinture polyester en poudre. Pintura poliéster en polvo.



Manganese metal.  
Métal manganèse.  
Metal manganeso.

Finishes for the top. Finitions pour le plateau. Acabados para el sobre.

Wood finishes. Finitions bois. Acabado de la madera.

Dekton® colours. Couleurs Dekton®. Colores Dekton®.



**RN**  
Natural oak.  
Chêne naturel.  
Roble natural.



**NA**  
Natural american walnut.  
Noyer américain.  
Nogal americano.



**RT**  
Dark stained oak.  
Chêne teint foncée.  
Roble teñido oscuro.



**RL**  
Oak painted in black with open-pore finish.  
Chêne laqué noir à pores ouverts.  
Roble lacado negro por abierto.



REM



KELYA



KIRA

Lacquered. Laqué. Lacados.



SEDA



ALOE



KHAKI



BRICK



RUBI



KOKOA

Leather. Cuir. Piel.



NUVOLA  
199



NUVOLA  
163



ELMOBALTIQUE  
88042



NUVOLA  
155



NUVOLA  
151



NUVOLA  
147



ELMOBALTIQUE  
33280



ELMOBALTIQUE  
43003



ELMOBALTIQUE  
99011

TAB.

PRICES. PRIX. PRECIOS.

TAB. Coffe table. Table basse. Mesa baja.



**TABCRT60FP**

60 x 60 H46.5  
23.62" x 23.62" H18.31"

Round top. Superellipse base.  
Plateau rond. Base superellipse.  
Sobre redondo. Base superelipse.



**TABCST60FP**

60 x 60 H46.5  
23.62" x 23.62" H18.31"

Superellipse top. Superellipse base.  
Plateau superellipse. Base superelipse.  
Sobre superelipse. Base superelipse.



**TABCRT60FC**

60 x 60 H46.5  
23.62" x 23.62" H18.31"

Round top. Cross-shaped base.  
Plateau rond. Base en croix. Sobre  
redondo. Base en cruz.



**TABCST60FC**

60 x 60 H46.5  
23.62" x 23.62" H18.31"

Superellipse top. Cross-shaped base.  
Plateau superellipse. Base en croix.  
Sobre superelipse. Base en cruz.

| MEASUREMENT. MESURE. MEDIDA.            | FINISHES. TRAITS. ACABADOS.   | REF.          | PRICE. PRIX. PRECIO. |
|---|---|---------------|----------------------|
| 60 x 60 H46.5   23.62" x 23.62" H18.31" | Natural oak. Chêne naturel. Roble natural.  | TABCRT60FPRN  | 776,86               |
| 60 x 60 H46.5   23.62" x 23.62" H18.31" | American walnut. Noyer américain. Nogal americano.  | TABCRT60FPNA  | 776,86               |
| 60 x 60 H46.5   23.62" x 23.62" H18.31" | Dark stained oak. Chêne teinté foncé. Roble teñido oscuro.  | TABCRT60FPRT  | 776,86               |
| 60 x 60 H46.5   23.62" x 23.62" H18.31" | Oak painted in black with open-pore finish. Chêne laqué noir à pores ouverts. Roble lacado negro por abierto. | TABCRT60FPRL  | 776,86               |
| 60 x 60 H46.5   23.62" x 23.62" H18.31" | Matt lacquer. Laque mate. Lacado mate.  | TABCRT60FPLA  | 681,82               |
| 60 x 60 H46.5   23.62" x 23.62" H18.31" | Leather. Cuir. Piel.  | TABCRT60FPLE  | 814,05               |
| 60 x 60 H46.5   23.62" x 23.62" H18.31" | Dekton®   | TABCRT60FPPDK | 814,05               |
| 60 x 60 H46.5   23.62" x 23.62" H18.31" | Natural oak. Chêne naturel. Roble natural.  | TABCST60FPRN  | 776,86               |
| 60 x 60 H46.5   23.62" x 23.62" H18.31" | American walnut. Noyer américain. Nogal americano.  | TABCST60FPNA  | 776,86               |
| 60 x 60 H46.5   23.62" x 23.62" H18.31" | Dark stained oak. Chêne teinté foncé. Roble teñido oscuro.  | TABCST60FPRT  | 776,86               |
| 60 x 60 H46.5   23.62" x 23.62" H18.31" | Oak painted in black with open-pore finish. Chêne laqué noir à pores ouverts. Roble lacado negro por abierto. | TABCST60FPRL  | 776,86               |
| 60 x 60 H46.5   23.62" x 23.62" H18.31" | Matt lacquer. Laque mate. Lacado mate.  | TABCST60FPLA  | 681,82               |
| 60 x 60 H46.5   23.62" x 23.62" H18.31" | Leather. Cuir. Piel.  | TABCST60FPLE  | 814,05               |
| 60 x 60 H46.5   23.62" x 23.62" H18.31" | Dekton®   | TABCST60FPPDK | 814,05               |
| 60 x 60 H46.5   23.62" x 23.62" H18.31" | Natural oak. Chêne naturel. Roble natural.  | TABCRT60FCRN  | 743,80               |
| 60 x 60 H46.5   23.62" x 23.62" H18.31" | American walnut. Noyer américain. Nogal americano.  | TABCRT60FCNA  | 743,80               |
| 60 x 60 H46.5   23.62" x 23.62" H18.31" | Dark stained oak. Chêne teinté foncé. Roble teñido oscuro.  | TABCRT60FCRT  | 743,80               |
| 60 x 60 H46.5   23.62" x 23.62" H18.31" | Oak painted in black with open-pore finish. Chêne laqué noir à pores ouverts. Roble lacado negro por abierto. | TABCRT60FCRL  | 743,80               |
| 60 x 60 H46.5   23.62" x 23.62" H18.31" | Matt lacquer. Laque mate. Lacado mate.  | TABCRT60FCLA  | 644,63               |
| 60 x 60 H46.5   23.62" x 23.62" H18.31" | Leather. Cuir. Piel.  | TABCRT60FCLE  | 776,86               |
| 60 x 60 H46.5   23.62" x 23.62" H18.31" | Dekton®   | TABCRT60FCDDK | 776,86               |
| 60 x 60 H46.5   23.62" x 23.62" H18.31" | Natural oak. Chêne naturel. Roble natural.  | TABCST60FCRN  | 743,80               |
| 60 x 60 H46.5   23.62" x 23.62" H18.31" | American walnut. Noyer américain. Nogal americano.  | TABCST60FCNA  | 743,80               |
| 60 x 60 H46.5   23.62" x 23.62" H18.31" | Dark stained oak. Chêne teinté foncé. Roble teñido oscuro.  | TABCST60FCRT  | 743,80               |
| 60 x 60 H46.5   23.62" x 23.62" H18.31" | Oak painted in black with open-pore finish. Chêne laqué noir à pores ouverts. Roble lacado negro por abierto. | TABCST60FCRL  | 743,80               |
| 60 x 60 H46.5   23.62" x 23.62" H18.31" | Matt lacquer. Laque mate. Lacado mate.  | TABCST60FCLA  | 644,63               |
| 60 x 60 H46.5   23.62" x 23.62" H18.31" | Leather. Cuir. Piel.  | TABCST60FCLE  | 776,86               |
| 60 x 60 H46.5   23.62" x 23.62" H18.31" | Dekton®   | TABCST60FCDDK | 776,86               |



TAB.

PRICES. PRIX. PRECIOS.

TAB. Coffe table. Table basse. Mesa baja.



**TABCRT85FP**

85 x 85 H46.5  
33.46" x 33.46" H18.31"

Round top. Superellipse base.  
Plateau rond. Base superellipse.  
Sobre redondo. Base superellipse.



**TABCST85FP**

85 x 85 H46.5  
33.46" x 33.46" H18.31"

Superellipse top. Superellipse base.  
Plateau superellipse. Base superellipse.  
Sobre superellipse. Base superellipse.



**TABCRT85FC**

85 x 85 H46.5  
33.46" x 33.46" H18.31"

Round top. Cross-shaped base.  
Plateau rond. Base en croix. Sobre  
redondo. Base en cruz.



**TABCST85FC**

85 x 85 H46.5  
33.46" x 33.46" H18.31"

Superellipse top. Cross-shaped base.  
Plateau superellipse. Base en croix.  
Sobre superellipse. Base en cruz.

| MEASUREMENT. MESURE. MEDIDA.            | FINISHES. TRAITS. ACABADOS.   | REF.         | PRICE. PRIX. PRECIO. |
|---|---|--------------|----------------------|
| 85 x 85 H46.5   33.46" x 33.46" H18.31" | Natural oak. Chêne naturel. Roble natural.  | TABCRT85FPRN | 938,02               |
| 85 x 85 H46.5   33.46" x 33.46" H18.31" | American walnut. Noyer américain. Nogal americano.  | TABCRT85FPNA | 938,02               |
| 85 x 85 H46.5   33.46" x 33.46" H18.31" | Dark stained oak. Chêne teinté foncé. Roble teñido oscuro.  | TABCRT85FPRT | 938,02               |
| 85 x 85 H46.5   33.46" x 33.46" H18.31" | Oak painted in black with open-pore finish. Chêne laqué noir à pores ouverts. Roble lacado negro por abierto. | TABCRT85FPRL | 938,02               |
| 85 x 85 H46.5   33.46" x 33.46" H18.31" | Matt lacquer. Laque mate. Lacado mate.  | TABCRT85FPLA | 822,31               |
| 85 x 85 H46.5   33.46" x 33.46" H18.31" | Leather. Cuir. Piel.  | TABCRT85FPLE | 1.264,46             |
| 85 x 85 H46.5   33.46" x 33.46" H18.31" | Dekton®   | TABCRT85FPDK | 1.264,46             |
| 85 x 85 H46.5   33.46" x 33.46" H18.31" | Natural oak. Chêne naturel. Roble natural.  | TABCST85FPRN | 938,02               |
| 85 x 85 H46.5   33.46" x 33.46" H18.31" | American walnut. Noyer américain. Nogal americano.  | TABCST85FPNA | 938,02               |
| 85 x 85 H46.5   33.46" x 33.46" H18.31" | Dark stained oak. Chêne teinté foncé. Roble teñido oscuro.  | TABCST85FPRT | 938,02               |
| 85 x 85 H46.5   33.46" x 33.46" H18.31" | Oak painted in black with open-pore finish. Chêne laqué noir à pores ouverts. Roble lacado negro por abierto. | TABCST85FPRL | 938,02               |
| 85 x 85 H46.5   33.46" x 33.46" H18.31" | Matt lacquer. Laque mate. Lacado mate.  | TABCST85FPLA | 822,31               |
| 85 x 85 H46.5   33.46" x 33.46" H18.31" | Leather. Cuir. Piel.  | TABCST85FPLE | 1.264,46             |
| 85 x 85 H46.5   33.46" x 33.46" H18.31" | Dekton®   | TABCST85FPDK | 1.115,70             |
| 85 x 85 H46.5   33.46" x 33.46" H18.31" | Natural oak. Chêne naturel. Roble natural.  | TABCRT85FCRN | 900,83               |
| 85 x 85 H46.5   33.46" x 33.46" H18.31" | American walnut. Noyer américain. Nogal americano.  | TABCRT85FCNA | 900,83               |
| 85 x 85 H46.5   33.46" x 33.46" H18.31" | Dark stained oak. Chêne teinté foncé. Roble teñido oscuro.  | TABCRT85FCRT | 900,83               |
| 85 x 85 H46.5   33.46" x 33.46" H18.31" | Oak painted in black with open-pore finish. Chêne laqué noir à pores ouverts. Roble lacado negro por abierto. | TABCRT85FCRL | 900,83               |
| 85 x 85 H46.5   33.46" x 33.46" H18.31" | Matt lacquer. Laque mate. Lacado mate.  | TABCRT85FCLA | 785,12               |
| 85 x 85 H46.5   33.46" x 33.46" H18.31" | Leather. Cuir. Piel.  | TABCRT85FCLE | 1.227,27             |
| 85 x 85 H46.5   33.46" x 33.46" H18.31" | Dekton®   | TABCRT85FCDK | 1.227,27             |
| 85 x 85 H46.5   33.46" x 33.46" H18.31" | Natural oak. Chêne naturel. Roble natural.  | TABCST85FCRN | 900,83               |
| 85 x 85 H46.5   33.46" x 33.46" H18.31" | American walnut. Noyer américain. Nogal americano.  | TABCST85FCNA | 900,83               |
| 85 x 85 H46.5   33.46" x 33.46" H18.31" | Dark stained oak. Chêne teinté foncé. Roble teñido oscuro.  | TABCST85FCRT | 900,83               |
| 85 x 85 H46.5   33.46" x 33.46" H18.31" | Oak painted in black with open-pore finish. Chêne laqué noir à pores ouverts. Roble lacado negro por abierto. | TABCST85FCRL | 900,83               |
| 85 x 85 H46.5   33.46" x 33.46" H18.31" | Matt lacquer. Laque mate. Lacado mate.  | TABCST85FCLA | 785,12               |
| 85 x 85 H46.5   33.46" x 33.46" H18.31" | Leather. Cuir. Piel.  | TABCST85FCLE | 1.227,27             |
| 85 x 85 H46.5   33.46" x 33.46" H18.31" | Dekton®   | TABCST85FCDK | 1.078,51             |

TAB.

PRICES. PRIX. PRECIOS.

TAB. Coffe table. Table basse. Mesa baja.



**TABCSRT90FP**

90 x 60 H46.5  
35.43" x 23.62" H18.31"

Superellipse rectangular top. Superellipse base.  
Plateau superellipse rectangolaire. Base superellipse.  
Sobre superelipse rectangular. Base superelipse.



**TABCSRT90FC**

90 x 60 H46.5  
35.43" x 23.62" H18.31"

Superellipse rectangular top. Cross-shaped base.  
Plateau superellipse rectangolaire. Base en croix.  
Sobre superelipse rectangular. Base en cruz.

| MEASUREMENT. MESURE. MEDIDA.            | FINISHES. TRAITS. ACABADOS.   | REF.          | PRICE. PRIX. PRECIO. |
|---|---|---------------|----------------------|
| 90 x 60 H46.5   35.43" x 23.62" H18.31" | Natural oak. Chêne naturel. Roble natural.  | TABCSRT90FPRN | 884,30               |
| 90 x 60 H46.5   35.43" x 23.62" H18.31" | American walnut. Noyer américain. Nogal americano.  | TABCSRT90FPNA | 884,30               |
| 90 x 60 H46.5   35.43" x 23.62" H18.31" | Dark stained oak. Chêne teinté foncé. Roble teñido oscuro.  | TABCSRT90FPRT | 884,30               |
| 90 x 60 H46.5   35.43" x 23.62" H18.31" | Oak painted in black with open-pore finish. Chêne laqué noir à pores ouverts. Roble lacado negro por abierto. | TABCSRT90FPRL | 884,30               |
| 90 x 60 H46.5   35.43" x 23.62" H18.31" | Matt lacquer. Laque mate. Lacado mate.  | TABCSRT90FPLA | 776,86               |
| 90 x 60 H46.5   35.43" x 23.62" H18.31" | Leather. Cuir. Piel.  | TABCSRT90FPLE | 983,47               |
| 90 x 60 H46.5   35.43" x 23.62" H18.31" | Dekton®   | TABCSRT90FPDK | 983,47               |
| 90 x 60 H46.5   35.43" x 23.62" H18.31" | Natural oak. Chêne naturel. Roble natural.  | TABCSRT90FCRN | 847,11               |
| 90 x 60 H46.5   35.43" x 23.62" H18.31" | American walnut. Noyer américain. Nogal americano.  | TABCSRT90FCNA | 847,11               |
| 90 x 60 H46.5   35.43" x 23.62" H18.31" | Dark stained oak. Chêne teinté foncé. Roble teñido oscuro.  | TABCSRT90FCRT | 847,11               |
| 90 x 60 H46.5   35.43" x 23.62" H18.31" | Oak painted in black with open-pore finish. Chêne laqué noir à pores ouverts. Roble lacado negro por abierto. | TABCSRT90FCRL | 847,11               |
| 90 x 60 H46.5   35.43" x 23.62" H18.31" | Matt lacquer. Laque mate. Lacado mate.  | TABCSRT90FCLA | 743,80               |
| 90 x 60 H46.5   35.43" x 23.62" H18.31" | Leather. Cuir. Piel.  | TABCSRT90FCLE | 946,28               |
| 90 x 60 H46.5   35.43" x 23.62" H18.31" | Dekton®   | TABCSRT90FCDK | 946,28               |

TAB.

PRICES. PRIX. PRECIOS.

TAB. Coffe table. Table basse. Mesa baja.

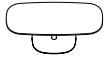

**TABCSRT1276FP**

127 x 60 H46.5  
50" x 23.62" H18.31"

Superellipse rectangular top. Superellipse base.  
Plateau superellipse rectangolaire. Base superellipse.  
Sobre superelipse rectangular. Base superelipse.



**TABCSRT1276FC**

127 x 60 H46.5  
50" x 23.62" H18.31"

Superellipse rectangular top. Cross-shaped base.  
Plateau superellipse rectangolaire. Base en croix.  
Sobre superelipse rectangular. Base en cruz.

| MEASUREMENT. MESURE. MEDIDA.          | FINISHES. TRAITS. ACABADOS.  | REF.            | PRICE. PRIX. PRECIO. |
|---------------------------------------|--|-----------------|----------------------|
| 127 x 60 H46.5   50.00 x 23.62 H18.31 | Natural oak. Chêne naturel. Roble natural.   | TABCSRT1276FPRN | 1.053,72             |
| 127 x 60 H46.5   50.00 x 23.62 H18.31 | American walnut. Noyer américain. Nogal americano.   | TABCSRT1276FPNA | 1.053,72             |
| 127 x 60 H46.5   50.00 x 23.62 H18.31 | Dark stained oak. Chêne teinté foncé. Roble teñido oscuro.   | TABCSRT1276FPRT | 1.053,72             |
| 127 x 60 H46.5   50.00 x 23.62 H18.31 | Oak painted in black with open-pore finish. Chêne laqué noir à pores ouverts. Roble lacado negro por abiertos. | TABCSRT1276FPRL | 1.053,72             |
| 127 x 60 H46.5   50.00 x 23.62 H18.31 | Matt lacquer. Laque mate. Lacado mate.   | TABCSRT1276FPLA | 929,75               |
| 127 x 60 H46.5   50.00 x 23.62 H18.31 | Leather. Cuir. Piel.   | TABCSRT1276FPLE | 1.202,48             |
| 127 x 60 H46.5   50.00 x 23.62 H18.31 | Dekton®  | TABCSRT1276FPDK | 1.202,48             |
| 127 x 60 H46.5   50.00 x 23.62 H18.31 | Natural oak. Chêne naturel. Roble natural.   | TABCSRT1276FCRN | 1.016,53             |
| 127 x 60 H46.5   50.00 x 23.62 H18.31 | American walnut. Noyer américain. Nogal americano.   | TABCSRT1276FCNA | 1.016,53             |
| 127 x 60 H46.5   50.00 x 23.62 H18.31 | Dark stained oak. Chêne teinté foncé. Roble teñido oscuro.   | TABCSRT1276FCRT | 1.016,53             |
| 127 x 60 H46.5   50.00 x 23.62 H18.31 | Oak painted in black with open-pore finish. Chêne laqué noir à pores ouverts. Roble lacado negro por abiertos. | TABCSRT1276FCRL | 1.016,53             |
| 127 x 60 H46.5   50.00 x 23.62 H18.31 | Matt lacquer. Laque mate. Lacado mate.   | TABCSRT1276FCLA | 892,56               |
| 127 x 60 H46.5   50.00 x 23.62 H18.31 | Leather. Cuir. Piel.   | TABCSRT1276FCLE | 1.165,29             |
| 127 x 60 H46.5   50.00 x 23.62 H18.31 | Dekton®  | TABCSRT1276FCDK | 1.165,29             |

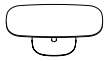

**TABCSRT1278FP**

127 x 85 H46.5  
50" x 33.46" H18.31"

Superellipse rectangular top. Superellipse base.  
Plateau superellipse rectangolaire. Base superellipse.  
Sobre superelipse rectangular. Base superelipse.



**TABCSRT1278FC**

127 x 85 H46.5  
50" x 33.46" H18.31"

Superellipse rectangular top. Cross-shaped base.  
Plateau superellipse rectangolaire. Base en croix.  
Sobre superelipse rectangular. Base en cruz.

| MEASUREMENT. MESURE. MEDIDA.          | FINISHES. TRAITS. ACABADOS.  | REF.            | PRICE. PRIX. PRECIO. |
|---------------------------------------|--|-----------------|----------------------|
| 127 x 85 H46.5   50.00 x 33.46 H18.31 | Natural oak. Chêne naturel. Roble natural.   | TABCSRT1278FPRN | 1.210,74             |
| 127 x 85 H46.5   50.00 x 33.46 H18.31 | American walnut. Noyer américain. Nogal americano.   | TABCSRT1278FPNA | 1.210,74             |
| 127 x 85 H46.5   50.00 x 33.46 H18.31 | Dark stained oak. Chêne teinté foncé. Roble teñido oscuro.   | TABCSRT1278FPRT | 1.210,74             |
| 127 x 85 H46.5   50.00 x 33.46 H18.31 | Oak painted in black with open-pore finish. Chêne laqué noir à pores ouverts. Roble lacado negro por abiertos. | TABCSRT1278FPRL | 1.210,74             |
| 127 x 85 H46.5   50.00 x 33.46 H18.31 | Matt lacquer. Laque mate. Lacado mate.   | TABCSRT1278FPLA | 1.078,51             |
| 127 x 85 H46.5   50.00 x 33.46 H18.31 | Leather. Cuir. Piel.   | TABCSRT1278FPLE | 1.458,68             |
| 127 x 85 H46.5   50.00 x 33.46 H18.31 | Dekton®  | TABCSRT1278FPDK | 1.458,68             |
| 127 x 85 H46.5   50.00 x 33.46 H18.31 | Natural oak. Chêne naturel. Roble natural.   | TABCSRT1278FCRN | 1.177,69             |
| 127 x 85 H46.5   50.00 x 33.46 H18.31 | American walnut. Noyer américain. Nogal americano.   | TABCSRT1278FCNA | 1.177,69             |
| 127 x 85 H46.5   50.00 x 33.46 H18.31 | Dark stained oak. Chêne teinté foncé. Roble teñido oscuro.   | TABCSRT1278FCRT | 1.177,69             |
| 127 x 85 H46.5   50.00 x 33.46 H18.31 | Oak painted in black with open-pore finish. Chêne laqué noir à pores ouverts. Roble lacado negro por abiertos. | TABCSRT1278FCRL | 1.177,69             |
| 127 x 85 H46.5   50.00 x 33.46 H18.31 | Matt lacquer. Laque mate. Lacado mate.   | TABCSRT1278FCLA | 1.045,45             |
| 127 x 85 H46.5   50.00 x 33.46 H18.31 | Leather. Cuir. Piel.   | TABCSRT1278FCLE | 1.425,62             |
| 127 x 85 H46.5   50.00 x 33.46 H18.31 | Dekton®  | TABCSRT1278FCDK | 1.425,62             |

# TAB.

# TABLE. MESA.



Designer  
Mario Ruiz

STYLE. ESTILO.  
Essential

VERSION. VERSIÓN.  
Side table. Table d'appoint. Mesa auxiliar.

## FEATURES. TRAITS. CARACTERÍSTICAS.

---

Available options for the top:  
American walnut, dark stained oak,  
dark oak or natural oak wood veneer,  
lacquered in different colours,  
upholstered in leather or Dekton® in 3  
finishes to choose.

Top base of MDF, KOKOA lacquered.

Available options for the base: cross-  
shaped or flat superellipse-shaped  
metal base coated with polyester  
powder manganese paint.

LPDE and felt stops.

Options disponibles pour le plateau:  
Placage de noyer américain, chêne  
teint, chêne noir ou chêne naturel,  
laqué de différentes couleurs,  
rembourré en cuir ou Dekton® en 3  
finitions au choix.

Base du plateau en MDF laquée  
couleur KOKOA.

Options disponibles pour la base:  
base métallique en forme de croix  
ou de superellipse plat avec un  
revêtement de peinture polyester en  
poudre finition manganèse.

Patins en PEBD et feutre.

Opciones disponibles para el sobre:  
Chapado en nogal americano, roble  
teñido oscuro, roble negro o roble  
natural, lacado en diferentes colores,  
tapizado en piel o Dekton® en 3  
acabados a elegir.

Base del sobre en DM lacadas en  
color KOKOA.

Opciones para la base: base metálica  
en forma de cruz o en forma de  
superelipse plana revestida con  
pintura poliéster en polvo acabado  
manganeso.

Protectores de LDPE y fieltro.

TAB.

GENERAL MEASUREMENTS. MESURES GÉNÉRALES. MEDIDAS GENERALES.

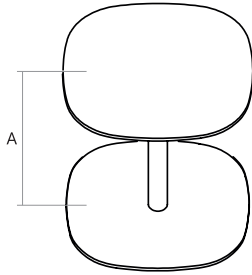

A. Height. Hauteur. Altura. 55.6 cm - 21.89"

FINISHES. TRAITS. ACABADOS.

Finishes for the metal bases. Finitions des bases métalliques. Acabados de las bases metálicas.

Polyester powder paint. Peinture polyester en poudre. Pintura poliéster en polvo.



Manganese metal.  
Métal manganèse.  
Metal manganeso.

Finishes for the top. Finitions pour le plateau. Acabados para el sobre.

Wood finishes. Finitions bois. Acabado de la madera.

Dekton® colours. Couleurs Dekton®. Colores Dekton®.



**RN**  
Natural oak.  
Chêne naturel.  
Roble natural.



**NA**  
Natural american walnut.  
Noyer américain.  
Nogal americano.



**RT**  
Dark stained oak.  
Chêne teint foncée.  
Roble teñido oscuro.



**RL**  
Oak painted in black with open-pore finish.  
Chêne laqué noir à pores ouverts.  
Roble lacado negro por abierto.



REM



KELYA



KIRA

Lacquered. Laqué. Lacados.



SEDA



ALOE



KHAKI



BRICK



RUBI



KOKOA

Leather. Cuir. Piel.



NUVOLA  
199



NUVOLA  
163



ELMOBALTIQUE  
88042



NUVOLA  
155



NUVOLA  
151



NUVOLA  
147



ELMOBALTIQUE  
33280



ELMOBALTIQUE  
43003



ELMOBALTIQUE  
99011

TAB.

PRICES. PRIX. PRECIOS.

TAB. Side table. Table d'appoint. Mesa auxiliar.



**TABART60FP**

60 x 60 H55.6  
23.62" x 23.62" H21.89"

Round top. Superellipse base.  
Plateau rond. Base superellipse.  
Sobre redondo. Base superelipse.



**TABAST60FP**

60 x 60 H55.6  
23.62" x 23.62" H21.89"

Superellipse top. Superellipse base.  
Plateau superellipse. Base superelipse.  
Sobre superelipse. Base superelipse.



**TABART60FC**

60 x 60 H55.6  
23.62" x 23.62" H21.89"

Round top. Cross-shaped base.  
Plateau rond. Base en croix. Sobre  
redondo. Base en cruz.



**TABAST60FC**

60 x 60 H55.6  
23.62" x 23.62" H21.89"

Superellipse top. Cross-shaped base.  
Plateau superelipse. Base en croix.  
Sobre superelipse. Base en cruz.

| MEASUREMENT. MESURE. MEDIDA.        | FINISHES. TRAITS. ACABADOS.   | REF.          | PRICE. PRIX. PRECIO. |
|-------------------------------------|---|---------------|----------------------|
| 60 x 60 H55.6   23.62x 23.62 H21.89 | Natural oak. Chêne naturel. Roble natural.  | TABART60FPRN  | 776,86               |
| 60 x 60 H55.6   23.62x 23.62 H21.89 | American walnut. Noyer américain. Nogal americano.  | TABART60FPNA  | 776,86               |
| 60 x 60 H55.6   23.62x 23.62 H21.89 | Dark stained oak. Chêne teinté foncé. Roble teñido oscuro.  | TABART60FPRT  | 776,86               |
| 60 x 60 H55.6   23.62x 23.62 H21.89 | Oak painted in black with open-pore finish. Chêne laqué noir à pores ouverts. Roble lacado negro por abierto. | TABART60FPRL  | 776,86               |
| 60 x 60 H55.6   23.62x 23.62 H21.89 | Matt lacquer. Laque mate. Lacado mate.  | TABART60FPLA  | 681,82               |
| 60 x 60 H55.6   23.62x 23.62 H21.89 | Leather. Cuir. Piel.  | TABART60FPLE  | 814,05               |
| 60 x 60 H55.6   23.62x 23.62 H21.89 | Dekton®   | TABART60FPDK  | 814,05               |
| 60 x 60 H55.6   23.62x 23.62 H21.89 | Natural oak. Chêne naturel. Roble natural.  | TABAST60FPRN  | 776,86               |
| 60 x 60 H55.6   23.62x 23.62 H21.89 | American walnut. Noyer américain. Nogal americano.  | TABAST60FPNA  | 776,86               |
| 60 x 60 H55.6   23.62x 23.62 H21.89 | Dark stained oak. Chêne teinté foncé. Roble teñido oscuro.  | TABAST60FPRT  | 776,86               |
| 60 x 60 H55.6   23.62x 23.62 H21.89 | Oak painted in black with open-pore finish. Chêne laqué noir à pores ouverts. Roble lacado negro por abierto. | TABAST60FPRL  | 776,86               |
| 60 x 60 H55.6   23.62x 23.62 H21.89 | Matt lacquer. Laque mate. Lacado mate.  | TABAST60FPLA  | 681,82               |
| 60 x 60 H55.6   23.62x 23.62 H21.89 | Leather. Cuir. Piel.  | TABAST60FPLE  | 814,05               |
| 60 x 60 H55.6   23.62x 23.62 H21.89 | Dekton®   | TABAST60FPDK  | 814,05               |
| 60 x 60 H55.6   23.62x 23.62 H21.89 | Natural oak. Chêne naturel. Roble natural.  | TABART60FCRN  | 743,80               |
| 60 x 60 H55.6   23.62x 23.62 H21.89 | American walnut. Noyer américain. Nogal americano.  | TABART60FCNA  | 743,80               |
| 60 x 60 H55.6   23.62x 23.62 H21.89 | Dark stained oak. Chêne teinté foncé. Roble teñido oscuro.  | TABART60FCRT  | 743,80               |
| 60 x 60 H55.6   23.62x 23.62 H21.89 | Oak painted in black with open-pore finish. Chêne laqué noir à pores ouverts. Roble lacado negro por abierto. | TABART60FCRL  | 743,80               |
| 60 x 60 H55.6   23.62x 23.62 H21.89 | Matt lacquer. Laque mate. Lacado mate.  | TABART60FCCLA | 644,63               |
| 60 x 60 H55.6   23.62x 23.62 H21.89 | Leather. Cuir. Piel.  | TABART60FCLE  | 776,86               |
| 60 x 60 H55.6   23.62x 23.62 H21.89 | Dekton®   | TABART60FCDK  | 776,86               |
| 60 x 60 H55.6   23.62x 23.62 H21.89 | Natural oak. Chêne naturel. Roble natural.  | TABAST60FCRN  | 743,80               |
| 60 x 60 H55.6   23.62x 23.62 H21.89 | American walnut. Noyer américain. Nogal americano.  | TABAST60FCNA  | 743,80               |
| 60 x 60 H55.6   23.62x 23.62 H21.89 | Dark stained oak. Chêne teinté foncé. Roble teñido oscuro.  | TABAST60FCRT  | 743,80               |
| 60 x 60 H55.6   23.62x 23.62 H21.89 | Oak painted in black with open-pore finish. Chêne laqué noir à pores ouverts. Roble lacado negro por abierto. | TABAST60FCRL  | 743,80               |
| 60 x 60 H55.6   23.62x 23.62 H21.89 | Matt lacquer. Laque mate. Lacado mate.  | TABAST60FCCLA | 644,63               |
| 60 x 60 H55.6   23.62x 23.62 H21.89 | Leather. Cuir. Piel.  | TABAST60FCLE  | 776,86               |
| 60 x 60 H55.6   23.62x 23.62 H21.89 | Dekton®   | TABAST60FCDK  | 776,86               |



# TAB.

# TABLE. MESA.



Designer  
Mario Ruiz

STYLE. ESTILO.  
Essential

VERSION. VERSIÓN.  
Task.

## FEATURES. TRAITS. CARACTERÍSTICAS.

---

Available options for the top:  
American walnut, dark stained oak,  
dark oak or natural oak wood veneer,  
lacquered in different colours,  
upholstered in leather or Dekton® in 3  
finishes to choose.

Top base of MDF, KOKOA lacquered.

Available options for the base: cross-  
shaped or flat superellipse-shaped  
metal base coated with polyester  
powder manganese paint.

LPDE and felt stops.

Options disponibles pour le plateau:  
Placage de noyer américain, chêne  
teint, chêne noir ou chêne naturel,  
laqué de différentes couleurs,  
rembourré en cuir ou Dekton® en 3  
finitions au choix.

Base du plateau en MDF laquée  
couleur KOKOA.

Options disponibles pour la base:  
base métallique en forme de croix  
ou de superellipse plat avec un  
revêtement de peinture polyester en  
poudre finition manganèse.

Patins en PEBD et feutre.

Opciones disponibles para el sobre:  
Chapado en nogal americano, roble  
teñido oscuro, roble negro o roble  
natural, lacado en diferentes colores,  
tapizado en piel o Dekton® en 3  
acabados a elegir.

Base del sobre en DM lacadas en  
color KOKOA.

Opciones para la base: base metálica  
en forma de cruz o en forma de  
superelipse plana revestida con  
pintura poliéster en polvo acabado  
manganeso.

Protectores de LDPE y fieltro.



TAB.

GENERAL MEASUREMENTS. MESURES GÉNÉRALES. MEDIDAS GENERALES.

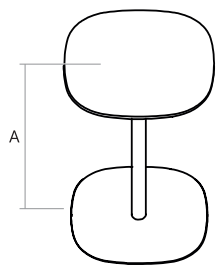

A. Height. Hauteur. Altura. 55.6 cm - 21.89"

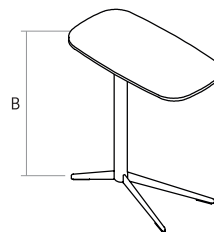

B. Height. Hauteur. Altura. 50.8 cm - 20"

FINISHES. TRAITS. ACABADOS.

Finishes for the metal bases. Finitions des bases métalliques. Acabados de las bases metálicas.

Polyester powder paint. Peinture polyester en poudre. Pintura poliéster en polvo.



Manganese metal.  
Métal manganèse.  
Metal manganeso.

Finishes for the top. Finitions pour le plateau. Acabados para el sobre.

Wood finishes. Finitions bois. Acabado de la madera.

Dekton® colours. Couleurs Dekton®. Colores Dekton®.



**RN**  
Natural oak.  
Chêne naturel.  
Roble natural.



**NA**  
Natural american walnut.  
Noyer américain.  
Nogal americano.



**RT**  
Dark stained oak.  
Chêne teint foncée.  
Roble teñido oscuro.



**RL**  
Oak painted in black with open-pore finish.  
Chêne laqué noir à pores ouverts.  
Roble lacado negro por abierto.



REM



KELYA



KIRA

Lacquered. Laqué. Lacados.



SEDA



ALOE



KHAKI



BRICK



RUBI



KOKOA

Leather. Cuir. Piel.



NUVOLA  
199



NUVOLA  
163



ELMOBALTIQUE  
88042



NUVOLA  
155



NUVOLA  
151



NUVOLA  
147



ELMOBALTIQUE  
33280



ELMOBALTIQUE  
43003



ELMOBALTIQUE  
99011

TAB.

PRICES. PRIX. PRECIOS.

TAB. Task Table. Table Task. Mesa Task.



**TABTRT43FP**

43 x 43 H55.6  
16.93"x 16.93" H21.89"

Round top. Superellipse base.  
Plateau rond. Base superellipse.  
Sobre redondo. Base superellipse.



**TABTST43FP**

43 x 43 H55.6  
16.93"x 16.93" H21.89"

Superellipse top. Superellipse base.  
Plateau superellipse. Base superellipse.  
Sobre superellipse. Base superellipse.



**TABTRT43FC**

43 x 43 H55.6  
16.93"x 16.93" H21.89"

Round top. Cross-shaped base.  
Plateau rond. Base en croix. Sobre  
redondo. Base en cruz.



**TABTST43FC**

43 x 43 H55.6  
16.93"x 16.93" H21.89"

Superellipse top. Cross-shaped base.  
Plateau superellipse. Base en croix.  
Sobre superellipse. Base en cruz.

| MEASUREMENT. MESURE. MEDIDA.        | FINISHES. TRAITS. ACABADOS.   | REF.          | PRICE. PRIX. PRECIO. |
|-------------------------------------|---|---------------|----------------------|
| 43 x 43 H55.6   16.93x 16.93 H21.89 | Natural oak. Chêne naturel. Roble natural.  | TABTRT43FPRN  | 723,14               |
| 43 x 43 H55.6   16.93x 16.93 H21.89 | American walnut. Noyer américain. Nogal americano.  | TABTRT43FPNA  | 723,14               |
| 43 x 43 H55.6   16.93x 16.93 H21.89 | Dark stained oak. Chêne teinté foncé. Roble teñido oscuro.  | TABTRT43FPRT  | 723,14               |
| 43 x 43 H55.6   16.93x 16.93 H21.89 | Oak painted in black with open-pore finish. Chêne laqué noir à pores ouverts. Roble lacado negro por abierto. | TABTRT43FPRL  | 723,14               |
| 43 x 43 H55.6   16.93x 16.93 H21.89 | Matt lacquer. Laque mate. Lacado mate.  | TABTRT43FPLA  | 636,36               |
| 43 x 43 H55.6   16.93x 16.93 H21.89 | Leather. Cuir. Piel.  | TABTRT43FPLE  | 752,07               |
| 43 x 43 H55.6   16.93x 16.93 H21.89 | Dekton®   | TABTRT43FPDK  | 752,07               |
| 43 x 43 H55.6   16.93x 16.93 H21.89 | Natural oak. Chêne naturel. Roble natural.  | TABTST43FPRN  | 723,14               |
| 43 x 43 H55.6   16.93x 16.93 H21.89 | American walnut. Noyer américain. Nogal americano.  | TABTST43FPNA  | 723,14               |
| 43 x 43 H55.6   16.93x 16.93 H21.89 | Dark stained oak. Chêne teinté foncé. Roble teñido oscuro.  | TABTST43FPRT  | 723,14               |
| 43 x 43 H55.6   16.93x 16.93 H21.89 | Oak painted in black with open-pore finish. Chêne laqué noir à pores ouverts. Roble lacado negro por abierto. | TABTST43FPRL  | 723,14               |
| 43 x 43 H55.6   16.93x 16.93 H21.89 | Matt lacquer. Laque mate. Lacado mate.  | TABTST43FPLA  | 636,36               |
| 43 x 43 H55.6   16.93x 16.93 H21.89 | Leather. Cuir. Piel.  | TABTST43FPLE  | 752,07               |
| 43 x 43 H55.6   16.93x 16.93 H21.89 | Dekton®   | TABTST43FPDK  | 673,55               |
| 43 x 43 H55.6   16.93x 16.93 H21.89 | Natural oak. Chêne naturel. Roble natural.  | TABTRT43FCRN  | 690,08               |
| 43 x 43 H55.6   16.93x 16.93 H21.89 | American walnut. Noyer américain. Nogal americano.  | TABTRT43FCNA  | 690,08               |
| 43 x 43 H55.6   16.93x 16.93 H21.89 | Dark stained oak. Chêne teinté foncé. Roble teñido oscuro.  | TABTRT43FCRT  | 690,08               |
| 43 x 43 H55.6   16.93x 16.93 H21.89 | Oak painted in black with open-pore finish. Chêne laqué noir à pores ouverts. Roble lacado negro por abierto. | TABTRT43FCRL  | 690,08               |
| 43 x 43 H55.6   16.93x 16.93 H21.89 | Matt lacquer. Laque mate. Lacado mate.  | TABTRT43FCCLA | 603,31               |
| 43 x 43 H55.6   16.93x 16.93 H21.89 | Leather. Cuir. Piel.  | TABTRT43FCLE  | 714,88               |
| 43 x 43 H55.6   16.93x 16.93 H21.89 | Dekton®   | TABTRT43FCDK  | 714,88               |
| 43 x 43 H55.6   16.93x 16.93 H21.89 | Natural oak. Chêne naturel. Roble natural.  | TABTST43FCRN  | 690,08               |
| 43 x 43 H55.6   16.93x 16.93 H21.89 | American walnut. Noyer américain. Nogal americano.  | TABTST43FCNA  | 690,08               |
| 43 x 43 H55.6   16.93x 16.93 H21.89 | Dark stained oak. Chêne teinté foncé. Roble teñido oscuro.  | TABTST43FCRT  | 690,08               |
| 43 x 43 H55.6   16.93x 16.93 H21.89 | Oak painted in black with open-pore finish. Chêne laqué noir à pores ouverts. Roble lacado negro por abierto. | TABTST43FCRL  | 690,08               |
| 43 x 43 H55.6   16.93x 16.93 H21.89 | Matt lacquer. Laque mate. Lacado mate.  | TABTST43FCCLA | 603,31               |
| 43 x 43 H55.6   16.93x 16.93 H21.89 | Leather. Cuir. Piel.  | TABTST43FCLE  | 714,88               |
| 43 x 43 H55.6   16.93x 16.93 H21.89 | Dekton®   | TABTST43FCDK  | 636,36               |

TAB.

PRICES. PRIX. PRECIOS.

TAB. Task Table. Table Task. Mesa Task.



**TABTRT50FC**

50 x 26 H50.8  
19.69" x 10.24" H20"

Superellipse rectangular top. Cross-shaped base.  
Plateau superellipse rectangolaire. Base en croix.  
Sobre superelipse rectangular. Base en cruz.

| MEASUREMENT. MESURE. MEDIDA.        | FINISHES. TRAITS. ACABADOS.   | REF.         | PRICE. PRIX. PRECIO. |
|-------------------------------------|---|--------------|----------------------|
| 50 x 26 H50.8   19.69x 10.24 H20.00 | Natural oak. Chêne naturel. Roble natural.  | TABTRT50FCRN | 714,88               |
| 50 x 26 H50.8   19.69x 10.24 H20.00 | American walnut. Noyer américain. Nogal americano.  | TABTRT50FCNA | 714,88               |
| 50 x 26 H50.8   19.69x 10.24 H20.00 | Dark stained oak. Chêne teinté foncé. Roble teñido oscuro.  | TABTRT50FCRT | 714,88               |
| 50 x 26 H50.8   19.69x 10.24 H20.00 | Oak painted in black with open-pore finish. Chêne laqué noir à pores ouverts. Roble lacado negro por abierto. | TABTRT50FCRL | 714,88               |
| 50 x 26 H50.8   19.69x 10.24 H20.00 | Matt lacquer. Laque mate. Lacado mate.  | TABTRT50FCLA | 619,83               |
| 50 x 26 H50.8   19.69x 10.24 H20.00 | Leather. Cuir. Piel.  | TABTRT50FCLE | 611,57               |
| 50 x 26 H50.8   19.69x 10.24 H20.00 | Dekton®   | TABTRT50FCDK | 611,57               |

# TAB.

# TABLE. MESA.



Designer  
Mario Ruiz

STYLE. ESTILO.  
Essential

VERSION. VERSIÓN.  
Worktable. Bureau. Trabajo.

## FEATURES. TRAITS. CARACTERÍSTICAS.

---

Available options for the top:  
American walnut, dark stained oak,  
dark oak or natural oak wood veneer,  
lacquered in different colours,  
upholstered in leather or Dekton® in 3  
finishes to choose.

Top base of MDF, KOKOA lacquered.

Available options for the base: cross-  
shaped or flat superellipse-shaped  
metal base coated with polyester  
powder manganese paint.

LPDE and felt stops.

Options disponibles pour le plateau:  
Placage de noyer américain, chêne  
teint, chêne noir ou chêne naturel,  
laqué de différentes couleurs,  
rembourré en cuir ou Dekton® en 3  
finitions au choix.

Base du plateau en MDF laquée  
couleur KOKOA.

Options disponibles pour la base:  
base métallique en forme de croix  
ou de superellipse plat avec un  
revêtement de peinture polyester en  
poudre finition manganèse.

Patins en PEBD et feutre.

Opciones disponibles para el sobre:  
Chapado en nogal americano, roble  
teñido oscuro, roble negro o roble  
natural, lacado en diferentes colores,  
tapizado en piel o Dekton® en 3  
acabados a elegir.

Base del sobre en DM lacadas en  
color KOKOA.

Opciones para la base: base metálica  
en forma de cruz o en forma de  
superelipse plana revestida con  
pintura poliéster en polvo acabado  
manganeso.

Protectores de LDPE y fieltro.

TAB.

GENERAL MEASUREMENTS. MESURES GÉNÉRALES. MEDIDAS GENERALES.

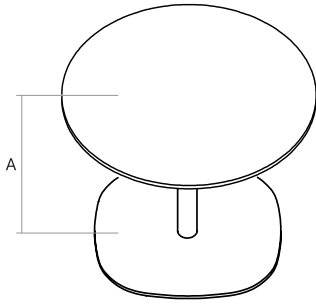

A. Height. Hauteur. Altura. 68 cm - 26.77"

FINISHES. TRAITS. ACABADOS.

Finishes for the metal bases. Finitions des bases métalliques. Acabados de las bases metálicas.

Polyester powder paint. Peinture polyester en poudre. Pintura poliéster en polvo.



Manganese metal.  
Métal manganèse.  
Metal manganeso.

Finishes for the top. Finitions pour le plateau. Acabados para el sobre.

Wood finishes. Finitions bois. Acabado de la madera.

Dekton® colours. Couleurs Dekton®. Colores Dekton®.



**RN**  
Natural oak.  
Chêne naturel.  
Roble natural.



**NA**  
Natural american walnut.  
Noyer américain.  
Nogal americano.



**RT**  
Dark stained oak.  
Chêne teint foncée.  
Roble teñido oscuro.



**RL**  
Oak painted in black with open-pore finish.  
Chêne laqué noir à pores ouverts.  
Roble lacado negro por abierto.



REM



KELYA



KIRA

Lacquered. Laqué. Lacados.



SEDA



ALOE



KHAKI



BRICK



RUBI



KOKOA

Leather. Cuir. Piel.



NUVOLA  
199



NUVOLA  
163



ELMOBALTIQUE  
88042



NUVOLA  
155



NUVOLA  
151



NUVOLA  
147



ELMOBALTIQUE  
33280



ELMOBALTIQUE  
43003



ELMOBALTIQUE  
99011

TAB.

PRICES. PRIX. PRECIOS.

TAB. Worktable. Bureau. Trabajo.



**TABWRT85FP**

85 x 85 H68  
33.46" x 33.46" H26.77"

Round top. Superellipse base.  
Plateau rond. Base superellipse.  
Sobre redondo. Base superelipse.



**TABWST85FP**

85 x 85 H68  
33.46" x 33.46" H26.77"

Superellipse top. Superellipse base.  
Plateau superellipse. Base superelipse.  
Sobre superelipse. Base superelipse.



**TABWRT85FC**

85 x 85 H68  
33.46" x 33.46" H26.77"

Round top. Cross-shaped base.  
Plateau rond. Base en croix. Sobre  
redondo. Base en cruz.



**TABWST85FC**

85 x 85 H68  
33.46" x 33.46" H26.77"

Superellipse top. Cross-shaped base.  
Plateau superellipse. Base en croix.  
Sobre superelipse. Base en cruz.

| MEASUREMENT. MESURE. MEDIDA.       | FINISHES. TRAITS. ACABADOS.   | REF.         | PRICE. PRIX. PRECIO. |
|------------------------------------|---|--------------|----------------------|
| 85 x 85 H68   33.46 x 33.46 H26.77 | Natural oak. Chêne naturel. Roble natural.  | TABWRT85FPRN | 938,02               |
| 85 x 85 H68   33.46 x 33.46 H26.77 | American walnut. Noyer américain. Nogal americano.  | TABWRT85FPNA | 938,02               |
| 85 x 85 H68   33.46 x 33.46 H26.77 | Dark stained oak. Chêne teinté foncé. Roble teñido oscuro.  | TABWRT85FPRT | 938,02               |
| 85 x 85 H68   33.46 x 33.46 H26.77 | Oak painted in black with open-pore finish. Chêne laqué noir à pores ouverts. Roble lacado negro por abierto. | TABWRT85FPRL | 938,02               |
| 85 x 85 H68   33.46 x 33.46 H26.77 | Matt lacquer. Laque mate. Lacado mate.  | TABWRT85FPLA | 822,31               |
| 85 x 85 H68   33.46 x 33.46 H26.77 | Leather. Cuir. Piel.  | TABWRT85FPLE | 1.264,46             |
| 85 x 85 H68   33.46 x 33.46 H26.77 | Dekton®   | TABWRT85FPDK | 1.264,46             |
| 85 x 85 H68   33.46 x 33.46 H26.77 | Natural oak. Chêne naturel. Roble natural.  | TABWST85FPRN | 938,02               |
| 85 x 85 H68   33.46 x 33.46 H26.77 | American walnut. Noyer américain. Nogal americano.  | TABWST85FPNA | 938,02               |
| 85 x 85 H68   33.46 x 33.46 H26.77 | Dark stained oak. Chêne teinté foncé. Roble teñido oscuro.  | TABWST85FPRT | 938,02               |
| 85 x 85 H68   33.46 x 33.46 H26.77 | Oak painted in black with open-pore finish. Chêne laqué noir à pores ouverts. Roble lacado negro por abierto. | TABWST85FPRL | 938,02               |
| 85 x 85 H68   33.46 x 33.46 H26.77 | Matt lacquer. Laque mate. Lacado mate.  | TABWST85FPLA | 822,31               |
| 85 x 85 H68   33.46 x 33.46 H26.77 | Leather. Cuir. Piel.  | TABWST85FPLE | 1.264,46             |
| 85 x 85 H68   33.46 x 33.46 H26.77 | Dekton®   | TABWST85FPDK | 1.115,70             |
| 85 x 85 H68   33.46 x 33.46 H26.77 | Natural oak. Chêne naturel. Roble natural.  | TABWRT85FCRN | 900,83               |
| 85 x 85 H68   33.46 x 33.46 H26.77 | American walnut. Noyer américain. Nogal americano.  | TABWRT85FCNA | 900,83               |
| 85 x 85 H68   33.46 x 33.46 H26.77 | Dark stained oak. Chêne teinté foncé. Roble teñido oscuro.  | TABWRT85FCRT | 900,83               |
| 85 x 85 H68   33.46 x 33.46 H26.77 | Oak painted in black with open-pore finish. Chêne laqué noir à pores ouverts. Roble lacado negro por abierto. | TABWRT85FCRL | 900,83               |
| 85 x 85 H68   33.46 x 33.46 H26.77 | Matt lacquer. Laque mate. Lacado mate.  | TABWRT85FCLA | 785,12               |
| 85 x 85 H68   33.46 x 33.46 H26.77 | Leather. Cuir. Piel.  | TABWRT85FCLE | 1.227,27             |
| 85 x 85 H68   33.46 x 33.46 H26.77 | Dekton®   | TABWRT85FCDK | 1.227,27             |
| 85 x 85 H68   33.46 x 33.46 H26.77 | Natural oak. Chêne naturel. Roble natural.  | TABWST85FCRN | 900,83               |
| 85 x 85 H68   33.46 x 33.46 H26.77 | American walnut. Noyer américain. Nogal americano.  | TABWST85FCNA | 900,83               |
| 85 x 85 H68   33.46 x 33.46 H26.77 | Dark stained oak. Chêne teinté foncé. Roble teñido oscuro.  | TABWST85FCRT | 900,83               |
| 85 x 85 H68   33.46 x 33.46 H26.77 | Oak painted in black with open-pore finish. Chêne laqué noir à pores ouverts. Roble lacado negro por abierto. | TABWST85FCRL | 900,83               |
| 85 x 85 H68   33.46 x 33.46 H26.77 | Matt lacquer. Laque mate. Lacado mate.  | TABWST85FCLA | 785,12               |
| 85 x 85 H68   33.46 x 33.46 H26.77 | Leather. Cuir. Piel.  | TABWST85FCLE | 1.227,27             |
| 85 x 85 H68   33.46 x 33.46 H26.77 | Dekton®   | TABWST85FCDK | 1.078,51             |

TAB.

PRICES. PRIX. PRECIOS.

TAB. Worktable. Bureau. Trabajo.

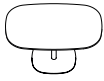

**TABWSRT1278FP**

127 x 85 H68  
50" x 33.46" H26.77"

Superellipse rectangular top. Superellipse base.  
Plateau superellipse rectangolaire. Base superellipse.  
Sobre superelipse rectangular. Base superelipse.



**TABWSRT1278FC**

127 x 85 H68  
50" x 33.46" H26.77"

Superellipse rectangular top. Cross-shaped base.  
Plateau superellipse rectangolaire. Base en croix.  
Sobre superelipse rectangular. Base en cruz.

| MEASUREMENT. MESURE. MEDIDA.        | FINISHES. TRAITS. ACABADOS.   | REF.             | PRICE. PRIX. PRECIO. |
|-------------------------------------|---|------------------|----------------------|
| 127 x 85 H68   50.00 x 33.46 H26.77 | Natural oak. Chêne naturel. Roble natural.  | TABWSRT1278FPRN  | 1.210,74             |
| 127 x 85 H68   50.00 x 33.46 H26.77 | American walnut. Noyer américain. Nogal americano.  | TABWSRT1278FPNA  | 1.210,74             |
| 127 x 85 H68   50.00 x 33.46 H26.77 | Dark stained oak. Chêne teinté foncé. Roble teñido oscuro.  | TABWSRT1278FPRT  | 1.210,74             |
| 127 x 85 H68   50.00 x 33.46 H26.77 | Oak painted in black with open-pore finish. Chêne laqué noir à pores ouverts. Roble lacado negro por abierto. | TABWSRT1278FPRL  | 1.210,74             |
| 127 x 85 H68   50.00 x 33.46 H26.77 | Matt lacquer. Laque mate. Lacado mate.  | TABWSRT1278FPLA  | 1.078,51             |
| 127 x 85 H68   50.00 x 33.46 H26.77 | Leather. Cuir. Piel.  | TABWSRT1278FPLE  | 1.458,68             |
| 127 x 85 H68   50.00 x 33.46 H26.77 | Dekton®   | TABWSRT1278FPDK  | 1.458,68             |
| 127 x 85 H68   50.00 x 33.46 H26.77 | Natural oak. Chêne naturel. Roble natural.  | TABWSRT1278FCRN  | 1.177,69             |
| 127 x 85 H68   50.00 x 33.46 H26.77 | American walnut. Noyer américain. Nogal americano.  | TABWSRT1278FCNA  | 1.177,69             |
| 127 x 85 H68   50.00 x 33.46 H26.77 | Dark stained oak. Chêne teinté foncé. Roble teñido oscuro.  | TABWSRT1278FCRT  | 1.177,69             |
| 127 x 85 H68   50.00 x 33.46 H26.77 | Oak painted in black with open-pore finish. Chêne laqué noir à pores ouverts. Roble lacado negro por abierto. | TABWSRT1278FCRL  | 1.177,69             |
| 127 x 85 H68   50.00 x 33.46 H26.77 | Matt lacquer. Laque mate. Lacado mate.  | TABWSRT1278FCCLA | 1.045,45             |
| 127 x 85 H68   50.00 x 33.46 H26.77 | Leather. Cuir. Piel.  | TABWSRT1278FCLE  | 1.425,62             |
| 127 x 85 H68   50.00 x 33.46 H26.77 | Dekton®   | TABWSRT1278FCDK  | 1.425,62             |

# MIKA.

# TRAY. PLATEAU. BANDEJA.



Designer  
Mario Ruiz

STYLE. ESTILO.  
Essential

## FEATURES. TRAITS. CARACTERÍSTICAS.

---

Tray with top covered in leather or Dekton® in 3 finishes to choose.

Tray body made of wood.

Finishes in American walnut, natural oak, dark stained oak, black oak or lacquered in different colours.

Its dimensions, 55 cm x 37 cm, allow it to fit on top of the SUMA bench.

Plateau recouvert de cuir ou Dekton® en 3 finitions au choix.

Corps de plateau en bois.

Finitions en noyer américain, chêne naturel, chêne teinté foncé, chêne noir ou laqué de différentes couleurs.

Sa mesure de 55 cm x 37 cm lui permet de s'adapter à la surface du banc SUMA.

Bandeja con sobre recubierto en piel o Dekton® en 3 acabados a elegir.

Cuerpo de la bandeja fabricado en madera en acabados nogal americano, roble natural, roble teñido oscuro, roble negro o lacado en distintos colores.

Su medida de 55 cm x 37 cm le permite encajar con la superficie del banco SUMA.



MIKA.

GENERAL MEASUREMENTS. MESURES GÉNÉRALES. MEDIDAS GENERALES.

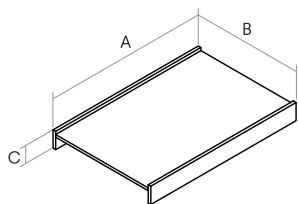

- A. Width. Largeur. Ancho. 55 cm - 21.65"
- B. Depth. Profondeur. Profundidad. 37 cm - 14.57"
- C. Height. Hauteur. Altura. 6 cm - 2.36"

FINISHES. TRAITS. ACABADOS.

Finishes for the top. Finitions pour le plateau. Acabados para el sobre.

Wood finishes. Finitions bois. Acabado de la madera.

Dekton® colours. Couleurs Dekton®. Colores Dekton®.



**RN**  
Natural oak.  
Chêne naturel.  
Roble natural.



**NA**  
Natural american walnut.  
Noyer américain.  
Nogal americano.



**RT**  
Dark stained oak.  
Chêne teint foncée.  
Roble teñido oscuro.



**RL**  
Oak painted in black with open-pore finish.  
Chêne laqué noir à pores ouverts.  
Roble lacado negro por abierto.



REM



KELYA



KIRA

Lacquered. Laqué. Lacados.



SEDA



ALOE



KHAKI



BRICK



RUBI



KOKOA

Leather. Cuir. Piel.



NUVOLA  
199



NUVOLA  
163



ELMOBALTIQUE  
88042



NUVOLA  
155



NUVOLA  
151



NUVOLA  
147



ELMOBALTIQUE  
33280



ELMOBALTIQUE  
43003



ELMOBALTIQUE  
99011

MIKA.

PRICES. PRIX. PRECIOS.

MIKA. Tray. Plateau. Bandeja.



**MIKT55LE**

55 x 37 H6  
21.65" x 14.57" H2.36"

Leather interior surface.  
Surface intérieure en cuir.  
Superficie interior en piel.



**MIKT55DK**

55 x 37 H6  
21.65" x 14.57" H2.36"

Dekton® interior surface.  
Surface intérieure en Dekton®.  
Superficie interior en Dekton®.

| MEASUREMENT. MESURE. MEDIDA.        | FINISHES. TRAITS. ACABADOS.   | REF.       | PRICE. PRIX. PRECIO. |
|-------------------------------------|---|------------|----------------------|
| 55 x 37 H6   21.65" x 14.57" H2.36" | Natural oak. Chêne naturel. Roble natural.  | MIKT55LERN | 553,72               |
| 55 x 37 H6   21.65" x 14.57" H2.36" | American walnut. Noyer américain. Nogal americano.  | MIKT55LENA | 566,12               |
| 55 x 37 H6   21.65" x 14.57" H2.36" | Dark stained oak. Chêne teinté foncé. Roble teñido oscuro.  | MIKT55LERT | 553,72               |
| 55 x 37 H6   21.65" x 14.57" H2.36" | Oak painted in black with open-pore finish. Chêne laqué noir à pores ouverts. Roble lacado negro por abierto. | MIKT55LERL | 566,12               |
| 55 x 37 H6   21.65" x 14.57" H2.36" | Matt lacquer. Laque mate. Lacado mate.  | MIKT55LELA | 454,55               |
| 55 x 37 H6   21.65" x 14.57" H2.36" | Natural oak. Chêne naturel. Roble natural.  | MIKT55DKRN | 471,07               |
| 55 x 37 H6   21.65" x 14.57" H2.36" | American walnut. Noyer américain. Nogal americano.  | MIKT55DKNA | 479,34               |
| 55 x 37 H6   21.65" x 14.57" H2.36" | Dark stained oak. Chêne teinté foncé. Roble teñido oscuro.  | MIKT55DKRT | 471,07               |
| 55 x 37 H6   21.65" x 14.57" H2.36" | Oak painted in black with open-pore finish. Chêne laqué noir à pores ouverts. Roble lacado negro por abierto. | MIKT55DKRL | 479,34               |
| 55 x 37 H6   21.65" x 14.57" H2.36" | Matt lacquer. Laque mate. Lacado mate.  | MIKT55DKLA | 367,77               |



# SERENE.

## DESK. BUREAUX. ESCRITORIO.



Designer  
Mario Ruiz

STYLE. ESTILO.  
Singular

### FEATURES. TRAITS. CARACTERÍSTICAS.

---

Freestanding desk in various dimensions.

Top covered in leather.

Structure made of wood.

Finishes in American walnut, natural oak, dark stained oak, black oak or lacquered in different colours.

Bases in metal coated in manganese colour polyester powder paint. LDPE stops.

Bureau sur pied en différentes dimensions.

Plateau recouvert de cuir.

Structure en bois.

Finitions en noyer américain, chêne naturel, chêne teinté foncé, chêne noir ou laqué de différentes couleurs.

Bases métalliques en peinture polyester en poudre finition manganèse. Patins en PEBD.

Escritorio freestanding de diferentes medidas.

Sobre recubierto en piel.

Estructura fabricada en madera en acabados nogal americano, roble natural, roble teñido oscuro, roble negro o lacada en distintos colores.

Bases fabricadas en metal recubiertas en pintura de poliéster en polvo color manganeso. Protectores de LDPE.

# SERENE.

## GENERAL MEASUREMENTS. MESURES GÉNÉRALES. MEDIDAS GENERALES.

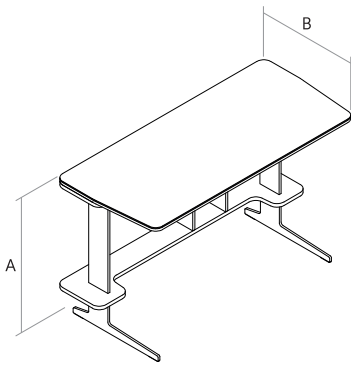

A. Width. Largeur. Ancho. 55 cm - 21.65"

B. Height. Hauteur. Altura. 79 cm - 31.10"

## FINISHES. TRAITS. ACABADOS.

Finishes for the metal bases. Finitions des bases métalliques. Acabados de las bases metálicas.

Polyester powder paint. Peinture polyester en poudre. Pintura poliéster en polvo.



Manganese metal.  
Métal manganèse.  
Metal manganeso.

Finishes for the top. Finitions pour le plateau. Acabados para el sobre.

Wood finishes. Finitions bois. Acabado de la madera.



**RN**  
Natural oak.  
Chêne naturel.  
Roble natural.



**NA**  
Natural american walnut.  
Noyer américain.  
Nogal americano.



**RT**  
Dark stained oak.  
Chêne teint foncée.  
Roble teñido oscuro.



**RL**  
Oak painted in black with open-pore finish.  
Chêne laqué noir à pores ouverts.  
Roble lacado negro por abierto.

Lacquered. Laqué. Lacados.



SEDA



ALOE



KHAKI



BRICK



RUBI



KOKOA

Leather. Cuir. Piel.



NUVOLA  
199



NUVOLA  
163



ELMOBALTIQUE  
88042



NUVOLA  
155



NUVOLA  
151



NUVOLA  
147



ELMOBALTIQUE  
33280



ELMOBALTIQUE  
43003



ELMOBALTIQUE  
99011

## SERENE.

PRICES. PRIX. PRECIOS.

SERENE. Desk. Bureau. Escritorio.

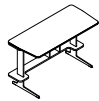

**SERD120**

120 x 55 H79  
47.24" x 21.65" H31.1"

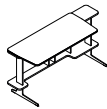

**SERD149**

149 x 55 H79  
58.66" x 21.65" H31.1"

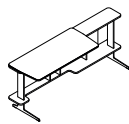

**SERD189**

189 x 55 H79  
74.41" x 21.65" H31.1"

| MEASUREMENT. MESURE. MEDIDA.          | FINISHES. TRAITS. ACABADOS.   | REF.      | PRICE. PRIX. PRECIO. |
|---------------------------------------|---|-----------|----------------------|
| 120 x 55 H79   47.24" x 21.65" H31.1" | Natural oak. Chêne naturel. Roble natural.  | SERD120RN | 2.504,13             |
| 120 x 55 H79   47.24" x 21.65" H31.1" | American walnut. Noyer américain. Nogal americano.  | SERD120NA | 2.615,70             |
| 120 x 55 H79   47.24" x 21.65" H31.1" | Dark stained oak. Chêne teinté foncé. Roble teñido oscuro.  | SERD120RT | 2.504,13             |
| 120 x 55 H79   47.24" x 21.65" H31.1" | Oak painted in black with open-pore finish. Chêne laqué noir à pores ouverts. Roble lacado negro por abierto. | SERD120RL | 2.615,70             |
| 120 x 55 H79   47.24" x 21.65" H31.1" | Matt lacquer. Laque mate. Lacado mate.  | SERD120LA | 2.599,17             |
| 149 x 55 H79   58.66" x 21.65" H31.1" | Natural oak. Chêne naturel. Roble natural.  | SERD149RN | 2.574,38             |
| 149 x 55 H79   58.66" x 21.65" H31.1" | American walnut. Noyer américain. Nogal americano.  | SERD149NA | 2.690,08             |
| 149 x 55 H79   58.66" x 21.65" H31.1" | Dark stained oak. Chêne teinté foncé. Roble teñido oscuro.  | SERD149RT | 2.574,38             |
| 149 x 55 H79   58.66" x 21.65" H31.1" | Oak painted in black with open-pore finish. Chêne laqué noir à pores ouverts. Roble lacado negro por abierto. | SERD149RL | 2.690,08             |
| 149 x 55 H79   58.66" x 21.65" H31.1" | Matt lacquer. Laque mate. Lacado mate.  | SERD149LA | 2.690,08             |
| 189 x 55 H79   74.41" x 21.65" H31.1" | Natural oak. Chêne naturel. Roble natural.  | SERD189RN | 2.785,12             |
| 189 x 55 H79   74.41" x 21.65" H31.1" | American walnut. Noyer américain. Nogal americano.  | SERD189NA | 2.917,36             |
| 189 x 55 H79   74.41" x 21.65" H31.1" | Dark stained oak. Chêne teinté foncé. Roble teñido oscuro.  | SERD189RT | 2.785,12             |
| 189 x 55 H79   74.41" x 21.65" H31.1" | Oak painted in black with open-pore finish. Chêne laqué noir à pores ouverts. Roble lacado negro por abierto. | SERD189RL | 2.917,36             |
| 189 x 55 H79   74.41" x 21.65" H31.1" | Matt lacquer. Laque mate. Lacado mate.  | SERD189LA | 2.942,15             |



# CUSHIONS.

# ROLLS & CUSHIONS. ROULEAUX ET COUSSINS. RULOS Y COJINES



STYLE. ESTILO.  
Essential

## FEATURES. TRAITS. CARACTERÍSTICAS.

---

### Cushions.

Complete removable upholstery.  
Stuffed with polyester fibre and washed, sterilised down.

### Textile.

Price per linear meter.  
(140 cm x 100 cm)

### Leather.

Foot price. A hide has an average of 50 to 55 feet.  
Prices do not include the transports costs.

### Coussins.

Tapiserie entièrement déhoussable.  
Garnis de fibre de polyester et plumes lavées et stérilisées.

### Tissu.

Prix au mètre linéal.  
(140 cm x 100 cm)

### Cuir.

Prix par pied en cuir. Un cuir a une moyenne de 50 - 55 pieds.  
Le prix ne comprend pas le transport.

### Cojines.

Tapicería totalmente desenfundable.  
Rellenos de fibra de poliéster y pluma lavada y esterilizada.

### Tejido.

Precio por metro lineal.  
(140 cm x 100 cm)

### Piel.

Precio por pie de piel. Una piel tiene un promedio de 50 a 55 pies.  
Los precios no incluyen cargo de portes.



## CUSHIONS.

PRICES. PRIX. PRECIOS.

CUSHIONS. Cushion. Coussin. Cojín.



### CN40X25

40 x H25  
15.75" x H9.84"

Cushion. Coussin. Cojín.



### CN40X40

40 x H40  
15.75" x H15.75"

Cushion. Coussin. Cojín.



### CN45X20

45 x H20  
17.72" x H7.87"

Cushion. Coussin. Cojín.



### CN45X40

45 x H40  
17.72" x H15.75"

Cushion. Coussin. Cojín.



### CN50X30

50 x H30  
19.69" x H11.81"

Cushion. Coussin. Cojín.



### CN50X40

50 x H40  
19.69" x H15.75"

Cushion. Coussin. Cojín.



### CN50X50

50 x H50  
19.69" x H19.69"

Cushion. Coussin. Cojín.

| MEASUREMENT. MESURE. MEDIDA. | REF.    | M.L. | COM / COL | 1     | 2      | 3      | 4      | 5      | L1     | L2     |
|------------------------------|---------|------|-----------|-------|--------|--------|--------|--------|--------|--------|
| 40 x 25   15.75" x 9.84"     | CN40X25 | 1    | 78,51     | 86,78 | 103,31 | 113,25 | 128,10 | 144,63 | 177,69 | 227,27 |
| 40 x 40   15.75" x 15.75"    | CN40X40 | 1    | 80,25     | 89,61 | 102,64 | 111,20 | 132,58 | 141,14 | 192,46 | 230,95 |
| 45 x 20   17.72" x 7.87"     | CN45X20 | 1.1  | 80,25     | 89,61 | 106,92 | 115,48 | 136,86 | 149,69 | 196,74 | 235,23 |
| 45 x 40   17.72" x 15.75"    | CN45X40 | 1.1  | 83,60     | 94,10 | 109,20 | 117,14 | 140,59 | 150,28 | 199,10 | 239,67 |
| 50 x 30   19.69" x 11.81"    | CN50X30 | 1.2  | 83,60     | 94,10 | 109,20 | 117,14 | 140,59 | 150,28 | 199,10 | 239,67 |
| 50 x H40   19.69" x H15.75"  | CN50X40 | 1.2  | 86,78     | 95,04 | 111,57 | 119,83 | 144,63 | 152,89 | 202,48 | 243,80 |
| 50 x H50   19.69" x H19.69"  | CN50X50 | 1.2  | 86,78     | 95,04 | 111,57 | 119,83 | 144,63 | 152,89 | 202,48 | 243,80 |

CUSHIONS. Oxford cushion. Coussin Oxford. Cojín Oxford.



### CUBO60H45

60 x H45  
23.62" x H17.72"

Oxford cushion.  
Coussin Oxford.  
Cojín Oxford.



### CUBO70H45

70 x H45  
27.56" x H17.72"

Oxford cushion.  
Coussin Oxford.  
Cojín Oxford.



### CUBO80H45

80 x H45  
31.50" x H17.72"

Oxford cushion.  
Coussin Oxford.  
Cojín Oxford.



### CUBO70H60

70 x H60  
27.56" x H23.62"

Oxford cushion.  
Coussin Oxford.  
Cojín Oxford.



### CUBO80H60

80 x H60  
31.50" x H23.62"

Oxford cushion.  
Coussin Oxford.  
Cojín Oxford.

| MEASUREMENT. MESURE. MEDIDA. | REF.      | M.L. | COM / COL | 1      | 2      | 3      | 4      | 5      | L1     | L2     |
|------------------------------|-----------|------|-----------|--------|--------|--------|--------|--------|--------|--------|
| 60 x H45   23.62" x H17.72"  | CUBO60H45 | 1.5  | 136,36    | 144,63 | 157,02 | 169,42 | 194,21 | 243,80 | 252,07 | 297,52 |
| 70 x H45   27.56" x H17.72"  | CUBO70H45 | 1.55 | 140,50    | 148,76 | 161,16 | 173,55 | 202,48 | 247,93 | 260,33 | 309,92 |
| 80 x H45   31.50" x H17.72"  | CUBO80H45 | 1.75 | 152,89    | 161,16 | 177,69 | 190,08 | 219,01 | 272,73 | 285,12 | 338,84 |
| 70 x H60   27.56" x H23.62"  | CUBO70H60 | 2.5  | 181,82    | 194,21 | 219,01 | 239,67 | 289,26 | 371,90 | 392,56 | 475,21 |
| 80 x H60   31.50" x H23.62"  | CUBO80H60 | 2.7  | 190,08    | 206,61 | 231,40 | 256,20 | 309,92 | 400,83 | 421,49 | 516,53 |

## CUSHIONS.

PRICES. PRIX. PRECIOS.

CUSHIONS. Cushion. Coussin. Cojín.



### CUB60H45

60 x H45  
23.62" x H17.72"

Cushion. Coussin. Cojín.



### CUB70H45

70 x H45  
27.56" x H17.72"

Cushion. Coussin. Cojín.

| MEASUREMENT. MESURE. MEDIDA. | REF.     | M.L. | COM / COL | 1      | 2      | 3      | 4      | 5      | L1     | L2     |
|------------------------------|----------|------|-----------|--------|--------|--------|--------|--------|--------|--------|
| 60 x H45   23.62" x H17.72"  | CUB60H45 | 1.5  | 95,04     | 103,31 | 111,57 | 119,83 | 136,36 | 169,42 | 177,69 | 206,61 |
| 70 x H45   27.56" x H17.72"  | CUB70H45 | 1.5  | 103,31    | 111,57 | 123,97 | 132,23 | 157,02 | 198,35 | 210,74 | 252,07 |

CUSHIONS. Oxford lumbar cushion. Coussin lombaire Oxford. Cojín lumbar Oxford.



### CUBO40H30

40 x H30  
15.75" x H11.81"

Oxford lumbar cushion.  
Coussin lombaire Oxford.  
Cojín lumbar Oxford.



### CUBO50H30

50 x H30  
19.69" x H11.81"

Oxford lumbar cushion.  
Coussin lombaire Oxford.  
Cojín lumbar Oxford.



### CUBO60H30

60 x H30  
23.62" x H11.81"

Oxford lumbar cushion.  
Coussin lombaire Oxford.  
Cojín lumbar Oxford.

| MEASUREMENT. MESURE. MEDIDA. | REF.      | M.L. | COM / COL | 1      | 2      | 3      | 4      | 5      | L1     | L2     |
|------------------------------|-----------|------|-----------|--------|--------|--------|--------|--------|--------|--------|
| 40 x H30   15.75" x H11.81"  | CUBO40H30 | 1.1  | 99,17     | 103,31 | 111,57 | 119,83 | 132,23 | 157,02 | 161,16 | 190,08 |
| 50 x H30   19.69" x H11.81"  | CUBO50H30 | 1.2  | 107,44    | 111,57 | 119,83 | 128,10 | 144,63 | 173,55 | 181,82 | 210,74 |
| 60 x H30   23.62" x H11.81"  | CUBO60H30 | 1.3  | 115,70    | 123,97 | 132,23 | 140,50 | 161,16 | 194,21 | 202,48 | 235,54 |

CUSHIONS. Lumbar cushion. Coussin lombaire. Cojín lumbar.



### CUB40H30

40 x H30  
15.75" x H11.81"

Lumbar cushion.  
Coussin lombaire.  
Cojín lumbar.



### CUB50H30

50 x H30  
19.69" x H11.81"

Lumbar cushion.  
Coussin lombaire.  
Cojín lumbar.



### CUB60H30

60 x H30  
23.62" x H11.81"

Lumbar cushion.  
Coussin lombaire.  
Cojín lumbar.

| MEASUREMENT. MESURE. MEDIDA. | REF.     | M.L. | COM / COL | 1     | 2     | 3      | 4      | 5      | L1     | L2     |
|------------------------------|----------|------|-----------|-------|-------|--------|--------|--------|--------|--------|
| 40 x H30   15.75" x H11.81"  | CUB40H30 | 1    | 78,51     | 78,51 | 86,78 | 90,91  | 103,31 | 119,83 | 123,97 | 144,63 |
| 50 x H30   19.69" x H11.81"  | CUB50H30 | 1.1  | 78,51     | 82,64 | 90,91 | 95,04  | 111,57 | 132,23 | 136,36 | 161,16 |
| 60 x H30   23.62" x H11.81"  | CUB60H30 | 1.2  | 86,78     | 95,04 | 99,17 | 107,44 | 123,97 | 152,89 | 157,02 | 185,95 |

**ROLLS.**

**PRICES. PRIX. PRECIOS.**

ROLLS. Roll. Rouleau. Rulo.



**ROL70D20**

70 x 20 x 20  
27.56" x 7.87" x 7.87"



**ROL80D20**

80 x 20 x 20  
31.50" x 7.87" x 7.87"



**ROL90D20**

90 x 20 x 20  
35.43" x 7.87" x 7.87"

| MEASUREMENT. MESURE. MEDIDA.          | REF.     | M.L. | COM / COL | 1      | 2      | 3      | 4      | 5      | L1     | L2     |
|---------------------------------------|----------|------|-----------|--------|--------|--------|--------|--------|--------|--------|
| 70 x 20 x 20   27.56" x 7.87" x 7.87" | ROL70D20 | 1.5  | 144,63    | 148,76 | 161,16 | 169,42 | 194,21 | 231,40 | 239,67 | 276,86 |
| 80 x 20 x 20   31.5" x 7.87" x 7.87"  | ROL80D20 | 1.5  | 157,02    | 165,29 | 177,69 | 185,95 | 210,74 | 252,07 | 264,46 | 305,79 |
| 90 x 20 x 20   35.43" x 7.87" x 7.87" | ROL90D20 | 1.6  | 169,42    | 177,69 | 190,08 | 202,48 | 227,27 | 272,73 | 285,12 | 330,58 |

Cut length service. Vente de tissu au mètre. Servicio de metrajes.

| MATERIAL. MATÉRIEL.     | REF. | M.L. | COM / COL | 1     | 2     | 3     | 4      | 5      | L1    | L2    |
|-------------------------|------|------|-----------|-------|-------|-------|--------|--------|-------|-------|
| Textile. Tissu. Tejido. | SMTO |      |           | 61,98 | 78,51 | 86,78 | 144,63 | 161,16 |       |       |
| Leather. Cuir. Piel.    | SMPL |      |           |       |       |       |        |        | 14,00 | 18,00 |

# GENERAL CONDITIONS. CONDITIONS GÉNÉRALES. CONDICIONES GENERALES.

These general conditions of sale apply in full to any order sent by the Buyer to JOQUER (hereinafter our Company) and its shipment implies their full and unreserved acceptance, even if they are not signed by the Buyer. The price is expressed in Euros, RRP, taxes not included. The corresponding trade discount will be applied to these prices. Joquer reserves the right to modify prices.

## ORDERS.

Only orders received in writing will be accepted, which must include the model, number of seats, fabric, colour and specific finish of the legs if there are alternatives. For orders of modular programmes, please accompany these with a small sketch. We will consider that the position of the arm is always seen from the front. The sales contract will be considered concluded and binding for both parties when the Order Confirmation is sent to the Buyer. The Order Confirmation shows the conditions of sale, and the items and quantities that will be served. It replaces the Buyer's Order. Changes to the order and/or cancellations will only be accepted within 3 days after the order confirmation date. In the event that the customer cancels an order that is already in production, Joquer has the right to claim a minimum of 20% of the total value of the order as compensation, reserving the right to file a claim if it is proven that the damages are greater. Under no circumstances may orders be cancelled when the shipment has already been made. Modifications to the finishes of the pieces after they have been received (changes in fillings, changes in legs, etc.) will be invoiced separately.

## PAYMENT CONDITIONS.

According to previously established commercial conditions. In the event that the customer delays payments more than is admissible or in the event that justified doubts arise regarding their solvency, Joquer will have the right to suspend the execution of the supplies in progress, cancel the contracts with the right to compensation for damages suffered or demand payment in advance. Claims regarding merchandise must be processed using the enabled methods. The customer is not entitled to withhold payment of invoices or make deductions on their own initiative. For custom product orders, Joquer does not accept any responsibility for these towards the customer or third parties. The characteristics of these products correspond to an express request of the customer and have not been subjected to the ordinary controls of the company. The order will not be put into production until the signed confirmation and the agreed down payment have been received. By accepting the order confirmation, the customer acknowledges that this is a special order. Consequently, it exonerates Joquer from any responsibility, since the production will be carried out according to the customer's order and may not coincide with the measurements, shapes or finishes shown in the Joquer general catalogue at the time of the order. The customer will indemnify Joquer

against any third-party claim for this reason.

## CUSTOMER FABRIC ORDERS.

All models can be made in Fabric or Customer Leather, with prior approval from Joquer. The quantity required is included in the price list. It always refers to the plain fabric, 140 cm wide. In any other case, always consult with the factory. In the case of Customer Leather, to calculate the necessary m<sup>2</sup>, the customer must multiply the metres that appear in the price list by 1.7. The fabrics and leathers received must include instructions for use, with the application side indicated, plus any other requirements. The reference and order number and the product that corresponds to each fabric must be clearly indicated. The fabrics must arrive with the postage paid, free of any additional charge. Any expenses paid by Joquer will be charged to the invoice.

## ATELIER SERVICE.

Joquer offers the possibility of making custom changes to its models as required by its customers, considering any modification as a special request. Modifications that involve variations in the structure, seat and/or back cushions of the model will increase the price by 20%. Modifications that involve variations in the arms, legs and seat and/or back cushions will increase the price by 10%. Modifications that imply variations in bed measurements will have a minimum price increase of 10%. Any modification must be confirmed by Joquer and the price quotation accepted in order to put it into production.

## TRANSPORT.

Our merchandise will be sent with freight costs paid in the Peninsula and the Balearic Islands. Orders that do not exceed €600 will be charged a supplement of €30. If any transport means other than the usual methods are requested, the merchandise will be sent with unpaid freight costs and under the responsibility of the customer. Joquer will only assume transportation to the commercial address or warehouse of its distributor. Deliveries to addresses other than the usual address of the customer must be previously consulted with the commercial department. If the shipment can be sent, it will be invoiced separately. The merchandise may remain in our warehouse for a maximum of 15 days without charge, but if it is not withdrawn within that time, storage costs of the merchandise of up to 0.6% per week will be assumed by the Buyer. The presence of the uncollected merchandise is understood as necessary storage and therefore excludes any liability of our Company for damages and defects that the merchandise may present. Except in the case of fraud or negligence by our Company, Joquer reserves the right to make partial shipments, after consultation with the customer. Joquer must be notified of any incident produced during transport (damage, stains, etc.) within a maximum of 72 hours after receipt. It is the

customer's responsibility to check the quantity and integrity of the merchandise received. If any anomaly is seen, the transporter must be notified, with a copy to Joquer, attaching the claim and corresponding graphic documentation. Special packaging can always be made upon request and after the acceptance of the price quote.

## WARRANTY.

Joquer guarantees the quality of the product throughout its manufacturing process and all its components as long as they are used for their specific purpose. Defects caused by negligence, knocks, inadequate cleaning products or changes in climate are not covered, nor are changes caused by environmental causes. The company declines any responsibility for damages resulting from misuse or improper treatment of the products, only accepting returns for manufacturing defects. This warranty applies to material and production errors that may occur with normal use and not to those that occur over time as a result of normal use (wear and tear). Aspects not covered by this warranty are, but are not restricted to, changes in colour, changes in wood textures, scratches during use, damage resulting from incorrect maintenance or use. The warranty does not cover, for example, discolouration of the covers, scratches, bumps and/or cracks in the varnish resulting from their use. It will be the Buyer's responsibility to provide our company with proof of correct use. The buyer must check the conformity of the merchandise and the absence of defects at the time of delivery. Claims must be made in writing within 7 days after receipt of the goods or in case of hidden defect, from its discovery. The products have a 2-year warranty from the date of purchase. Joquer declines all responsibility related to the quality of the fabrics sent by the customer. No liability will be accepted for accidental damage to people or things as a result of improper use of the product. Misuse, modifications or third-party repairs lead to the loss of the warranty.

## COMPETENCES.

In the event of litigation, the jurisdiction and competence of the Courts of Barcelona will be expressly accepted.

# GENERAL CONDITIONS. CONDITIONS GÉNÉRALES. CONDICIONES GENERALES.

Les présentes conditions générales de vente s'appliquent pleinement à toute commande passée par l'Acheteur auprès de JOQUER (ci-après notre Société) et son expédition implique de sa part l'acceptation pleine et sans réserve des présentes conditions générales de vente, même si celles-ci ne sont pas signées par l'Acheteur. Le tarif est exprimé en Euros, Prix de vente au public, hors taxes. La remise commerciale correspondante sera appliquée sur ces prix. Joquer se réserve le droit de modifier les prix.

## COMMANDES.

Ne seront prises en compte que les commandes reçues par écrit, sur lesquelles devront figurer le modèle, les places, le tissu, la couleur et la finition spécifique des pieds dans le cas où il existe une autre option. Pour les commandes de programmes modulaires, il convient de les accompagner d'un petit croquis. Nous considérerons que la position de l'accoudoir est toujours vue de face. Le contrat de vente sera réputé conclu, engageant les deux parties, dès lors où la Confirmation de commande a été envoyée à l'Acheteur. La Confirmation de commande indique les conditions de vente, ainsi que les articles et les quantités qui seront fournis, et remplace la Commande de l'Acheteur. Les modifications de la commande et les annulations ne seront acceptées que dans les 3 jours suivant la date de confirmation de la commande. Dans le cas où le client annulerait une commande déjà en production, Joquer aura le droit de réclamer un minimum de 20 % de la valeur totale de la commande à titre d'indemnisation, se réservant le droit de réclamer s'il est démontré que les dommages sont plus importants. Les commandes qui auront déjà été expédiées ne pourront en aucun cas être annulées. Les modifications dans les finitions des pièces après leur réception (changements de rembourrages, changements de pieds, etc.) seront facturées séparément.

## CONDITIONS DE PAIEMENT.

Selon les conditions commerciales préalablement établies. Dans le cas où le client retarderait les paiements au-delà de ce qui est raisonnablement admissible ou que des doutes justifiés sont soulevés quant à sa solvabilité, Joquer aura le droit de suspendre l'exécution des fournitures en cours, d'annuler les contrats avec possibilité d'indemnisation pour les dommages subis ou d'exiger le paiement à l'avance. Les réclamations concernant la marchandise doivent s'effectuer en utilisant les méthodes prévues à cet effet. Le client n'a pas le droit de retenir le paiement des factures ou de procéder à des déductions de sa propre initiative. Pour les commandes de produits sur mesure, Joquer décline toute responsabilité à cet égard envers le client ou des tiers. Les caractéristiques de ces produits correspondent à une demande expresse du client et n'ont pas été soumises aux contrôles ordinaires de la Société. La commande ne sera mise en production qu'après réception de la confirmation signée et de l'acompte convenu. En acceptant la confirmation de commande, le client reconnaît qu'il s'agit d'une commande particulière. Par conséquent,

Joquer est exonéré de toute responsabilité, étant donné que la production sera réalisée conformément à la commande du client et pourrait ne pas coïncider avec les dimensions, formes ou finitions indiquées dans le catalogue général Joquer au moment de la commande. Le client indemnisera Joquer contre toute réclamation de tiers pour ce motif.

## COMMANDES TISSU CLIENT.

Tous les modèles peuvent être réalisés en Tissu ou en Cuir Client, avec l'accord préalable de Joquer. La quantité nécessaire est indiquée dans le tarif. Il s'agit toujours d'un tissu uni de 140 cm de large.

Dans tous les autres cas, toujours vérifier auprès de l'usine. Dans le cas de Cuir Client, pour calculer les m2 nécessaires, il convient de multiplier les mètres figurant dans le tarif par 1,7. Les tissus et cuirs reçus doivent être accompagnés d'une notice d'utilisation, indiquer le côté à appliquer ou toute autre exigence. La référence et le numéro de commande ainsi que le produit qui correspond à chaque tissu doivent être clairement indiqués. Les tissus doivent arriver franco de port, les éventuels frais payés par Joquer seront portés sur la facture.

## SERVICE D'ATELIER.

Joquer offre la possibilité d'apporter des modifications sur mesure à ses modèles selon les besoins de ses clients, ces modifications étant considérées comme une demande spéciale. Les modifications qui impliquent des variations dans la structure, les coussins d'assise et/ou de dossier du modèle, entraînent une hausse du prix de 20 %. Les modifications impliquant des variations au niveau des accoudoirs, des pieds et des coussins d'assise et/ou de dossier entraînent une hausse du prix de 10 %. Les modifications qui impliquent des variations dans les dimensions des lits entraîneront une hausse minimum de 10 %. Toute modification doit être confirmée par Joquer et son budget accepté pour la mettre en production.

## TRANSPORT.

Nos marchandises seront envoyées en port payé dans la péninsule et les îles Baléares. Pour les commandes ne dépassant pas 600 €, un supplément de 30 € sera facturé. En cas de demande d'un moyen de transport autre que le moyen habituel, la marchandise voyagera en port dû et sous la responsabilité du client. Joquer n'assumera que le transport jusqu'à l'adresse commerciale ou l'entrepôt de son distributeur. Les livraisons à des adresses autres que les adresses habituelles du client doivent faire l'objet d'une vérification préalable auprès du service commercial. Si celles-ci peuvent être réalisées, elles seront facturées séparément. La marchandise pourra rester dans notre entrepôt pendant un maximum de 15 jours sans frais, mais si elle n'est pas retirée dans ce délai, l'Acheteur sera responsable des frais de garde de la marchandise pouvant s'élever jusqu'à 0,6 % par semaine. Le séjour de la marchandise non enlevée constitue un dépôt nécessaire. Notre Société est donc exonérée de toute responsabilité pour les dommages et

défauts que la marchandise pourrait présenter, sauf en cas de faute intentionnelle ou de négligence de la part de notre Société. Joquer se réserve le droit d'effectuer des envois partiels, après vérification auprès du client. Tout incident survenu lors du transport (casse, tâches, etc.) devra être notifié à Joquer dans un délai maximum de 72 heures après réception. Il appartient au client de vérifier la quantité et l'intégrité de la marchandise reçue. Toute anomalie observée devra être notifiée au transporteur, avec copie à Joquer, en joignant la réclamation et la documentation graphique correspondante. Un emballage spécial peut être réalisé après demande préalable et acceptation du devis.

## GARANTIE.

Joquer garantit la qualité du produit tout au long de son processus de fabrication et de tous ses composants dès lors où ils sont utilisés pour leurs usages spécifiques. Les défauts causés par des négligences, des coups, des produits de nettoyage inadéquats ou des changements climatiques ne sont pas couverts, pas plus que les changements provoqués par des causes environnementales. La Société décline toute responsabilité pour les dommages résultant d'une mauvaise utilisation ou d'un mauvais traitement des produits, n'acceptant les retours que pour défauts de fabrication. La garantie s'applique aux erreurs de matériaux et de fabrication pouvant survenir lors d'une utilisation normale et non à celles qui surviennent au fil du temps dans le cadre d'une utilisation normale (usure). Les aspects non couverts par cette garantie sont, sans s'y limiter, les changements de couleur, les changements de textures de bois, les éraflures causées par l'utilisation, les dommages résultant d'un entretien ou d'une utilisation inadéquats. La garantie ne couvre pas, par exemple, la décoloration des housses, les éraflures, les coups et/ou les fissures sur le vernis résultant de leur utilisation. Il appartient à l'Acheteur d'apporter à notre Société la preuve de la bonne utilisation. L'Acheteur devra vérifier la conformité de la marchandise et l'absence de défauts au moment de la livraison. Les réclamations doivent être formulées par écrit dans un délai de 7 jours à compter de la réception de la marchandise ou en cas de vice caché, à compter de sa découverte. Les produits bénéficient d'une garantie de 2 ans à compter de la date d'achat. Joquer décline toute responsabilité liée à la qualité des tissus envoyés par le client. Notre Société décline toute responsabilité pour les dommages accidentels causés à des personnes ou à des choses résultant d'une mauvaise utilisation du produit. Une mauvaise utilisation, des modifications ou des réparations par des tiers entraînent la perte de la garantie.

## COMPÉTENCES.

En cas de litige, les parties se soumettent expressément à la juridiction et à la compétence des Tribunaux de Barcelone.

# GENERAL CONDITIONS. CONDITIONS GÉNÉRALES. CONDICIONES GENERALES.

Estas condiciones generales de venta se aplican íntegramente a cualquier pedido enviado por parte del Comprador a JOQUER (en adelante nuestra Empresa) y su envío supone la aceptación íntegra y sin reservas por su parte de estas condiciones generales de venta, aunque no estén firmadas por el Comprador. La tarifa está expresada en Euros, Precio Venta Público, impuestos no incluidos. Sobre estos precios se aplicará el descuento comercial correspondiente. Joquer se reserva el derecho de modificar los precios.

## PEDIDOS.

Solo se considerarán pedidos los recibidos por escrito, donde deberá figurar el modelo, plazas, tejido, color y acabado específico de las patas en el caso de existir alternativa. Para pedidos de programas modulares rogamos acompañen a éstos de un pequeño croquis. Consideraremos que la posición del brazo es siempre vista de frente. El contrato de venta se considerará concluido, resultante vinculante para ambas partes, cuando le sea enviada al Comprador la Confirmación de pedido. La Confirmación de pedido muestra las condiciones de venta, y los artículos y cantidades que serán servidos y reemplaza al Pedido del Comprador. Los cambios en el pedido y anulaciones sólo serán admitidos en el plazo de 3 días posteriores a la fecha de confirmación de pedido. En caso de que el cliente anule un pedido que ya está en producción, Joquer tendrá derecho a reclamar un mínimo del 20% del valor total del pedido en concepto de indemnización, reservándose el derecho de reclamar si se demuestran que los daños son superiores. En modo alguno se podrán anular pedidos en los que ya se haya realizado la expedición. Las modificaciones en los acabados de las piezas posteriores a la recepción de éstas (cambios de rellenos, cambios de patas, etc.), se facturarán aparte.

## CONDICIONES DE PAGO.

Según condiciones comerciales previamente establecidas. En el caso que el cliente retrase los pagos más de lo admisible o en caso de que surgieran dudas justificadas de su solvencia, Joquer tendrá derecho a suspender la ejecución de los suministros en curso, anular los contratos con facultada de indemnización por daños sufridos o exigir el pago por adelantado. Reclamaciones relativas a la mercancía se deberán tramitar utilizando los métodos habilitados. El cliente no está facultado a retener el pago de facturas o efectuar deducciones por iniciativa propia. Para pedidos de producto a medida, Joquer no acepta ninguna responsabilidad sobre éstos frente al cliente o terceros. Las características de estos productos corresponden a una petición expresa del cliente y no se han sometido a los controles ordinarios de la empresa. El pedido no se pondrá en fabricación hasta que no se haya recibido la confirmación firmada y la paga señal acordada. Aceptando la confirmación de pedido, el cliente reconoce que se trata de un pedido especial. Consecuentemente

exonera a Joquer de cualquier responsabilidad, dado que la producción se realizará según encargo del cliente y podría no coincidir con las medidas, formas o acabados mostrados en el catálogo general de Joquer en el momento del pedido. El cliente indemnizará a Joquer de la reclamación de cualquier tercero por este motivo.

## PEDIDOS TELA CLIENTE.

Todos los modelos pueden realizarse en Tela o Piel Cliente, previa aprobación de Joquer. La cantidad necesaria está recogida en la tarifa. Siempre se refiere a una tela lisa de 140cm de ancho. En cualquier otro caso consultar siempre a fábrica. En caso de Piel Cliente, para calcular los m2 necesarios, deben multiplicar los metros que aparecen en la tarifa por 1,7. Las telas y pieles recibidas deben incluir instrucciones de uso, indicar la cara de aplicación o cualquier otro requisito. Debe indicarse claramente la referencia y número de pedido y el producto que corresponde a cada tejido. Los tejidos deben llegar a portes pagados, libres de cualquier cargo, cualquier gasto pagado por Joquer se cargará en factura.

## SERVICIO ATELIER.

Joquer ofrece la posibilidad de efectuar cambios a medida sobre sus modelos según requieran sus clientes, considerando cualquier modificación como pedido especial. Las modificaciones que implican variaciones en la estructura, en los cojines de asiento y/o respaldo del modelo, incrementan el precio en un 20%. Las modificaciones que implican variaciones en brazos, patas y cojines de asiento y/o respaldo aumentarán un 10%. Las modificaciones que implican variaciones en las medidas de las camas tendrán un incremento mínimo del 10%. Cualquier modificación debe ser confirmada por Joquer y aceptado su presupuesto para ponerla en producción.

## TRANSPORTE.

Nuestra mercancía será remitida a portes pagados en Península y Baleares. Los pedidos que no superen los 600€ se cargarán con un suplemento de 30€. En caso de solicitar un medio distinto al habitual, la mercancía viajará a portes debidos y bajo responsabilidad del cliente. Joquer solo asumirá el transporte hasta la dirección comercial o almacén de su distribuidor. Las entregas a direcciones distintas de las habituales del cliente deben consultarse previamente con el departamento comercial. De poder realizarse éstas se facturarán aparte. La mercancía podrá permanecer en nuestro almacén un máximo de 15 días sin cargo, pero si no se realiza la retirada de esta en ese tiempo, correrán a cargo del Comprador los gastos de custodia de la mercancía de hasta 0.6% por semana. La permanencia de mercancía no retirada se entiende a título de depósito necesario y por tanto queda excluida cualquier responsabilidad de nuestra Empresa por daños y defectos que pueda presentar la

mercancía, salvo dolo o negligencia de nuestra Empresa. Joquer se reserva el derecho de realizar envíos parciales, previa consulta con el cliente. Cualquier incidencia producida durante el transporte (roturas, manchas, etc.), notificadas a Joquer con un máximo de 72h después de su recepción. Corresponde al cliente comprobar la cantidad e integridad de la mercancía recibida. De observarse cualquier anomalía deberá notificarse al transporte, con copia a Joquer, adjuntando la reclamación y documentación gráfica correspondiente. Puede realizarse embalaje especial siempre previa petición y aceptación del presupuesto.

## GARANTÍA.

Joquer garantiza la calidad del producto a lo largo de su proceso de fabricación y todos sus componentes siempre y cuando éstos sean usados para sus específicos usos. Defectos causados por negligencias, golpes, productos de limpieza inadecuados o cambios de clima no están cubiertos, así como tampoco los cambios causados por causa medioambientales. La empresa declina cualquier responsabilidad por desperfectos derivados de un mal uso o tratamiento indebido de los productos, aceptando únicamente las devoluciones por defectos de fabricación. La garantía se aplica a los errores de materiales y de producción que puedan ocurrir con un uso normal y no a aquellos que ocurran en el transcurso del tiempo fruto del uso normal (desgaste). Aspectos que no cubre esta garantía son, pero no quedan restringidos, cambios de color, cambios en las texturas de las maderas, arañazos durante el uso, daños resultantes de un mantenimiento o uso incorrecto. La garantía no cubre, por ejemplo, decoloración de las fundas, arañazos, golpes y/o fisuras en el barniz fruto de su uso. Será responsabilidad del Comprador proporcionar a nuestra empresa la prueba de haber realizado un uso correcto. El comprador deberá comprobar la conformidad de la mercancía y la ausencia de defectos en el momento de la entrega de esta. Las reclamaciones deben realizarse por escrito dentro de los 7 días posteriores a la recepción de la mercancía o en caso de defecto oculto, desde su descubrimiento. Los productos tienen una garantía de 2 años a partir de la fecha de adquisición. Joquer declina toda responsabilidad relacionada con la calidad de los tejidos enviados por el cliente. Ninguna responsabilidad será admitida por daños accidentales a personas o cosas como consecuencia de usos inadecuados del producto. Mal uso, modificaciones o reparaciones de terceros conllevan la pérdida de la garantía.

## COMPETENCIAS.

En caso de litigio se aceptará expresamente la jurisdicción y competencia de los Juzgados de Barcelona.

